

Honeywell

HF680 (Second Generation)

Hand-Free Area-Imaging Scanner



User Guide

Disclaimer

Honeywell International Inc. ("HII") reserves the right to make changes in specifications and other information contained in this document without prior notice, and the reader should in all cases consult HII to determine whether any such changes have been made. The information in this publication does not represent a commitment on the part of HII.

HII shall not be liable for technical or editorial errors or omissions contained herein; nor for incidental or consequential damages resulting from the furnishing, performance, or use of this material. HII disclaims all responsibility for the selection and use of software and/or hardware to achieve intended results.

This document contains proprietary information that is protected by copyright. All rights are reserved. No part of this document may be photocopied, reproduced, or translated into another language without the prior written consent of HII.

Copyright © 2020 Honeywell International Inc. All rights reserved.

Web Address: www.honeywellaidc.com

Other product names or marks mentioned in this document may be trademarks or registered trademarks of other companies and are the property of their respective owners.

For patent information, refer to www.hsmpats.com.

TABLE OF CONTENTS

Customer Support	ix
Technical Assistance	ix
Product Service and Repair	ix
Limited Warranty	ix
Chapter 1 - Get Started	1
About This Manual.....	1
Unpack Your Device.....	1
Connect the Device.....	2
Connect with USB.....	2
Connect with RS232 Serial Port	2
Reading Techniques.....	3
Menu Barcode Security Settings	3
Set Custom Defaults	3
Reset the Custom Defaults.....	4
Chapter 2 - Program the Interface	5
Introduction.....	5
Program the Interface - Plug and Play	5
RS232 Serial Port	5
USB IBM SurePos.....	6
USB PC or Macintosh Keyboard.....	6
USB HID	7
USB Serial.....	7

CTS/RTS Emulation	7
ACK/NAK Mode.....	7
Remote MasterMind™ for USB	8
Keyboard Country Layout.....	8
Keyboard Style	15
Keyboard Conversion	16
Control Character Output.....	17
Keyboard Modifiers.....	17
RS232 Modifiers	19
RS232 Baud Rate	19
RS232 Word Length: Data Bits, Stop Bits, and Parity	20
RS232 Receiver Time-Out	21
RS232 Handshaking.....	21
RS232 Timeout.....	22
XON/XOFF.....	22
ACK/NAK	23
Scanner to Bioptic Communication.....	23
Scanner-Bioptic Packet Mode	23
Scanner-Bioptic ACK/NAK Mode	24
Scanner-Bioptic ACK/NAK Timeout.....	24

Chapter 3 - Input/Output Settings..... 25

Power Up Beeper.....	25
Beep on BEL Character	25
Good Read and Error Indicators	26
Beeper – Good Read.....	26
Beeper Volume – Good Read	26
Beeper Pitch – Good Read	26
Beeper Pitch – Error	27
Beeper Duration – Good Read.....	27
LED – Good Read	28
Number of Beeps – Good Read.....	28
Number of Beeps – Error.....	28

Good Read Delay.....	29
User-Specified Good Read Delay	29
IR Trigger Mode.....	29
LED Illumination.....	30
Serial Trigger Mode	30
Read Time-Out.....	30
Presentation Mode	31
Presentation Centering	31
Streaming Presentation Mode	33
Read Mode	33
Poor Quality Codes	34
Poor Quality 1D Codes	34
Poor Quality PDF Codes.....	35
Reread Delay	35
User-Specified Reread Delay.....	36
2D Reread Delay	36
Character Activation Mode.....	36
Activation Character.....	37
End Character Activation After Good Read	37
Character Activation Timeout.....	38
Character Deactivation Mode	38
Deactivation Character	38
Illumination Lights	38
No Read.....	39
Video Reverse.....	39
Working Orientation.....	40

Chapter 4 - Data Edit43

Prefix/Suffix Overview	43
To Add a Prefix or Suffix:	44
Clear One or All Prefixes or Suffixes.....	44
Add a Carriage Return Suffix to All Symbolologies.....	45
Prefix Selections	45

Suffix Selections.....	45
Function Code Transmit.....	46
Intercharacter, Interfunction, and Intermessage Delays.....	46
Intercharacter Delay	46
User Specified Intercharacter Delay.....	47
Interfunction Delay	47
Intermessage Delay.....	48

Chapter 5 - Data Format 49

Data Format Editor Introduction.....	49
Show Data Format.....	50
Add a Data Format.....	50
Other Programming Selections.....	51
Terminal ID Table.....	52
Data Format Editor Commands.....	52
Move Commands	55
Search Commands	56
Miscellaneous Commands.....	58
Data Formatter.....	61
Primary/Alternate Data Formats	61

Chapter 6 - Symbologies..... 63

All Symbologies	64
Message Length Description.....	64
Codabar	65
Codabar Concatenation	66
Code 39.....	67
Code 32 Pharmaceutical (PARAF).....	69
Full ASCII	70
Code 39 Code Page	70
Interleaved 2 of 5	71
NEC 2 of 5.....	72
Code 93.....	74

Code 93 Code Page.....	75
Straight 2 of 5 Industrial (three-bar start/stop).....	75
Straight 2 of 5 IATA (two-bar start/stop).....	76
Matrix 2 of 5.....	77
Code 11.....	78
Code 128.....	79
ISBT 128 Concatenation.....	79
Code 128 Code Page.....	80
GS1-128.....	81
UPC-A.....	82
UPC-A/EAN-13 with Extended Coupon Code.....	84
Coupon GS1 DataBar Output.....	85
UPC-E0.....	85
UPC-E1.....	87
EAN/JAN-13.....	88
Convert UPC-A to EAN-13.....	88
ISBN Translate.....	90
EAN/JAN-8.....	91
MSI.....	93
GS1 DataBar Omnidirectional.....	94
GS1 DataBar Limited.....	95
GS1 DataBar Expanded.....	95
Codablock A.....	96
Codablock F.....	97
PDF417.....	98
MacroPDF417.....	98
MicroPDF417.....	99
GS1 Composite Codes.....	100
UPC/EAN Version.....	100
GS1 Emulation.....	101
TCIF Linked Code 39 (TLC39).....	102
QR Code.....	102

QR Code Append	103
QR Code Page	104
Data Matrix.....	104
Data Matrix Code Page	105
MaxiCode	105
Aztec Code	106
Aztec Code Page	108
Chinese Sensible (Han Xin) Code	108
Postal Codes - 2D	109
Single 2D Postal Codes:.....	109
Combination 2D Postal Codes:.....	110
Postal Codes - Linear	113
China Post (Hong Kong 2 of 5)	113
Korea Post	114

Chapter 7 - Utilities.....117

Add a Test Code I.D. Prefix to All Symbologies	117
Show Software Revision	117
Show Data Format.....	117
Test Menu	118
EZConfig for Scanning Introduction.....	118
Install EZConfig Cloud for Scanning.....	119
Reset the Factory Defaults.....	119

Chapter 8 - Serial Programming Commands.....121

Conventions	121
Menu Command Syntax	121
Query Commands.....	122
Trigger Commands.....	124
Reset the Custom Defaults	125
Menu Commands	125

Chapter 9 - Product Specifications143

HF680 Scanner Product Specifications143
Depth of Field Charts144
 Typical Performance.....144
 Guaranteed Performance.....144
Standard Cable Pinouts145
 Serial Output145
 USB.....145
Required Safety Labels.....146

Chapter 10 - Maintenance and Troubleshooting147

Repairs.....147
Maintenance.....147
 Clean the Scanner.....147
 Inspect Cords and Connectors.....148
Replace Cables.....148
 Replace an Interface Cable.....148
Troubleshoot.....148

Appendix A - Reference Charts.....151

Symbology Charts.....151
 Linear Symbologies151
 2D Symbologies152
 Postal Symbologies153
ASCII Conversion Chart (Code Page 1252)154
Lower ASCII Reference Table.....155
ISO 2022/ISO 646 Character Replacements158
Keyboard Key References.....161

Sample Symbols.....163

Programming Chart165

Customer Support

Technical Assistance

To search our knowledge base for a solution or to log in to the Technical Support portal and report a problem, go to www.hsmcontactsupport.com.

For our latest contact information, see www.honeywellaidc.com/locations.

Product Service and Repair

Honeywell International Inc. provides service for all of its products through service centers throughout the world. To obtain warranty or non-warranty service, return your product to Honeywell (postage paid) with a copy of the dated purchase record. To learn more, go to www.honeywellaidc.com and select **Service & Repair** at the bottom of the page.

Limited Warranty

For warranty information, go to www.honeywellaidc.com and click **Resources > Product Warranty**.

About This Manual

This User Guide provides installation and programming instructions for the Second Generation HF680 Hand-Free Area-Imaging Scanner. Product specifications, dimensions, warranty, and customer support information are also included.

Honeywell barcode scanners are factory programmed for the most common terminal and communications settings. If you need to change these settings, programming is accomplished by scanning the barcodes in this guide.

An asterisk (*) next to an option indicates the default setting.

This guide is only intended for HF680 Second Generation use. Before starting, verify the scanner's part number includes "-R" after HF680 (e.g., HF680-Rx-xxxxxx). The part number can be found on the label on the bottom of your device (see page [146](#)).

Note: For earlier models, refer to HF680-EN-QS, available for download at honeywellaidc.com (region dependent).

Unpack Your Device

After you open the shipping carton containing the product, take the following steps:

- Check for damage during shipment. Report damage immediately to the carrier who delivered the carton.
- Make sure the items in the carton match your order.
- Save the shipping container for later storage or shipping.

Connect the Device

Connect with USB

A scanner can be connected to the USB port of a computer.

1. Connect the appropriate interface cable to the device first, then to the computer.

HF680 USB Connection:

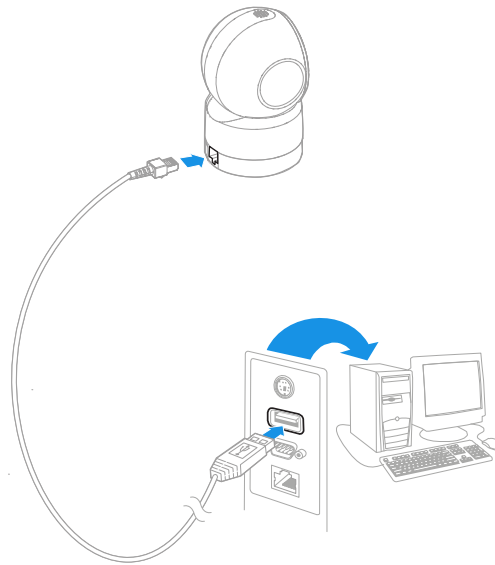

Note: The power supply must be ordered separately, if needed.

2. The scanner beeps.
3. Verify the scanner operation by scanning a barcode from the [Sample Symbols](#) in the back of this manual.

The unit defaults to a USB PC Keyboard. Refer to [page 6](#) for other USB terminal settings.

For additional USB programming and technical information, refer to “USB Application Note,” available at www.honeywellaidc.com.

Connect with RS232 Serial Port

1. Turn off power to the terminal/computer.
2. Connect the appropriate interface cable to the device.

Note: For the scanner to work properly, you must have the correct cable for your type of terminal/computer.

HF680 RS232 Serial Port Connection:

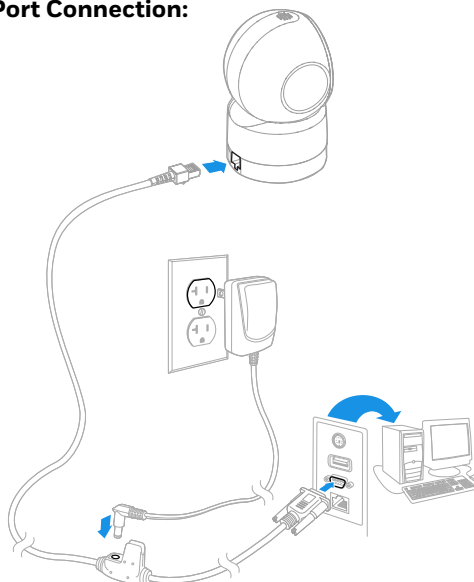

1. Plug the serial connector into the serial port on your computer. Tighten the two screws to secure the connector to the port.
2. Once the scanner has been fully connected, power up the computer.

This interface programs 115,200 baud, 8 data bits, no parity, and 1 stop bit.

Reading Techniques

Symbologies with smaller bars or elements (mil size) should be read closer to the unit. Symbologies with larger bars or elements (mil size) should be read farther from the unit. If the code being scanned is highly reflective (e.g., laminated), it may be necessary to tilt the code up 15° to 18° to prevent unwanted reflection.

Menu Barcode Security Settings

Honeywell scanners are programmed by scanning menu barcodes or by sending serial commands to the scanner. If you want to restrict the ability to scan menu codes, you can use the Menu barcode Security settings. Please contact the nearest technical support office (see [Customer Support](#) on page ix) for further information.

Set Custom Defaults

You have the ability to create a set of menu commands as your own, custom defaults. To do so, scan the **Set Custom Defaults** barcode below before scanning the menu commands for your custom defaults. If a menu command requires scanning numeric codes from the [Programming Chart](#), then a **Save** code, that

entire sequence will be saved to your custom defaults. When you have entered all the commands you want to save for your custom defaults, scan the **Save Custom Defaults** barcode.



You may have a series of custom settings and want to correct a single setting. To do so, just scan the new setting to overwrite the old one. For example, if you had previously saved the setting for Beeper Volume at Low to your custom defaults, and decide you want the beeper volume set to High, just scan the **Set Custom Defaults** barcode, then scan the **Beeper Volume High** menu code, and then **Save Custom Defaults**. The rest of the custom defaults will remain, but the beeper volume setting will be updated.

Reset the Custom Defaults

If you want the custom default settings restored to your scanner, scan the **Activate Custom Defaults** barcode below. This is the recommended default barcode for most users. It resets the scanner to the custom default settings. If there are no custom defaults, it will reset the scanner to the factory default settings. Any settings that have not been specified through the custom defaults will be defaulted to the factory default settings.



Introduction

This chapter describes how to program your system for the desired interface.

Program the Interface - Plug and Play

Plug and Play barcodes provide instant scanner set up for commonly used interfaces.

Note: After you scan one of the codes, power cycle the host terminal to have the interface in effect.

RS232 Serial Port

The **RS232 Interface** barcode is used when connecting to the serial port of a PC or terminal. The following **RS232 Interface** barcode also programs a carriage return (CR) and a line feed (LF) suffix, baud rate, and data format as indicated below. It also changes the trigger mode to manual.

Option	Setting
Baud Rate	115,200 bps
Data Format	8 data bits, no parity bit, 1 stop bit



PAP232.

RS232 Interface

USB IBM SurePos

Scan one of the following “Plug and Play” codes to program the scanner for an IBM SurePos (USB handheld scanner) or IBM SurePos (USB tabletop scanner) interface.

Note: After scanning one of these codes, you must power cycle the cash register.



Each barcode above also programs the following suffixes for each symbology:

Symbology	Suffix	Symbology	Suffix
EAN 8	0C	Code 39	00 0A 0B
EAN 13	16	Interleaved 2 of 5	00 0D 0B
UPC A	0D	Code 128	00 18 0B
UPC E	0A	Code 39	00 0A 0B

USB PC or Macintosh Keyboard

Scan one of the following codes to program the scanner for USB PC Keyboard or USB Macintosh Keyboard. Scanning these codes also adds a CR and LF.



USB HID

Scan the following code to program the scanner for USB HID barcode scanners.



USB Serial

Scan the following code to program the scanner to emulate a regular RS232-based COM Port. If you are using a Microsoft® Windows® PC, you will need to download a driver from the Honeywell website (www.honeywellaidc.com). The driver will use the next available COM Port number. Apple® Macintosh computers recognize the scanner as a USB CDC class device and automatically uses a class driver.



Note: No extra configuration (e.g., baud rate) is necessary.

CTS/RTS Emulation



ACK/NAK Mode



Remote MasterMind™ for USB

When using a USB interface, you may wish to configure your scanner to communicate with Remote MasterMind Scanner Management Software (ReM). Scan the **ReM On** barcode to communicate with ReM. To disable this capability, scan **ReM Off**. *Default = ReM On.*



Keyboard Country Layout

If your interface is USB Keyboard or Keyboard Wedge, your keyboard layout default is a US keyboard. To change this layout, refer to the chart below for your keyboard country. Scan the appropriate barcode below to change the layout.

By default, national character replacements are used for the following characters: # \$ @ [\] ^ { | } ~ See [ISO 2022/ISO 646 Character Replacements](#) on page A-158 to view the character replacements for each country.

Keyboard Countries



Keyboard Countries (Continued)



KBDCTY33.
Bosnia



KBDCTY59.
Brazil (MS)



KBDCTY53.
Bulgaria (Latin)



KBDCTY18.
Canada (French)



KBDCTY32.
Croatia



KBDCTY40.
Czech (Programmers)



KBDCTY1.
Belgium



KBDCTY16.
Brazil



KBDCTY52.
Bulgaria (Cyrillic)



KBDCTY54.
Canada (French legacy)



KBDCTY55.
Canada (Multilingual)



KBDCTY15.
Czech

Keyboard Countries (Continued)



KBDCTY38.
Czech (QWERTZ)



KBDCTY11.
Dutch (Netherlands)



KBDCTY83.
Faroese



KBDCTY3.
France



KBDCTY4.
Germany



KBDCTY64.
Greek (220 Latin)



KBDCTY39.
Czech (QWERTY)



KBDCTY8.
Denmark



KBDCTY41.
Estonia



KBDCTY2.
Finland



KBDCTY84.
Gaelic



KBDCTY17.
Greek

Keyboard Countries (Continued)



KBDCTY65.
Greek (319 Latin)



KBDCTY63.
Greek (Latin)



KBDCTY60.
Greek (Polytonic)



KBDCTY50.
Hungarian (101 key)



KBDCTY75.
Iceland



KBDCTY56.
Italian (142)



KBDCTY61.
Greek (220)



KBDCTY62.
Greek (319)



KBDCTY66.
Greek (MS)



KBDCTY12.
Hebrew



KBDCTY19.
Hungary



KBDCTY73.
Irish

Keyboard Countries (Continued)



KBDCTY5.
Italy



KBDCTY28.
Japan ASCII



KBDCTY78.
Kazakh



KBDCTY79.
Kyrgyz (Cyrillic)



KBDCTY14.
Latin America



KBDCTY42.
Latvia



KBDCTY43.
Latvia (QWERTY)



KBDCTY44.
Lithuania



KBDCTY45.
Lithuania (IBM)



KBDCTY34.
Macedonia



KBDCTY74.
Malta



KBDCTY86.
Mongolian (Cyrillic)

Keyboard Countries (Continued)



KBDCTY9.
Norway



KBDCTY20.
Poland



KBDCTY57.
Polish (214)



KBDCTY58.
Polish (Programmers)



KBDCTY13.
Portugal



KBDCTY25.
Romania



KBDCTY26.
Russia



KBDCTY67.
Russian (MS)



KBDCTY68.
Russian (Typewriter)



KBDCTY21.
SCS



KBDCTY37.
Serbia (Cyrillic)



KBDCTY36.
Serbia (Latin)

Keyboard Countries (Continued)



KBDCTY22.
Slovakia



KBDCTY49.
Slovakia (QWERTY)



KBDCTY48.
Slovakia (QWERTZ)



KBDCTY31.
Slovenia



KBDCTY10.
Spain



KBDCTY51.
Spanish variation



KBDCTY23.
Sweden



KBDCTY29.
Switzerland (French)



KBDCTY6.
Switzerland (German)



KBDCTY85.
Tatar



KBDCTY27.
Turkey F



KBDCTY24.
Turkey Q

Keyboard Countries (Continued)



KBDCTY76.
Ukrainian



KBDCTY7.
United Kingdom



KBDCTY87.
United States (Dvorak)



KBDCTY88.
United States (Dvorak left)



KBDCTY89.
United States (Dvorak)



KBDCTY30.
United States (International)



KBDCTY77.
Uzbek (Cyrillic)

Keyboard Style

This programs keyboard styles, such as Caps Lock and Shift Lock. If you have used [Keyboard Conversion](#) settings, they will override any of the following Keyboard Style settings. *Default = Regular.*

Regular is used when you normally have the Caps Lock key off.



KBDSTY0.
* Regular

Caps Lock is used when you normally have the Caps Lock key on.



KBDSTY1.
Caps Lock

Shift Lock is used when you normally have the Shift Lock key on (not common to U.S. keyboards).



Automatic Caps Lock is used if you change the Caps Lock key on and off. The software tracks and reflects if you have Caps Lock on or off. This selection can only be used with systems that have an LED that notes the Caps Lock status (AT keyboards).



The **Autocaps via NumLock** barcode should be scanned in countries (e.g., Germany, France) where the Caps Lock key cannot be used to toggle Caps Lock. The NumLock option works similarly to the regular Autocaps, but uses the NumLock key to retrieve the current state of the Caps Lock.



Emulate External Keyboard should be scanned if you do not have an external keyboard (IBM AT or equivalent).



Note: After scanning the **Emulate External Keyboard** barcode, you must power cycle your computer.

Keyboard Conversion

Alphabetic keyboard characters can be forced to be all upper case or all lowercase. So if you have the following barcode: “abc569GK,” you can make the output “ABC569GK” by scanning **Convert All Characters to Upper Case**, or to “abc569gk” by scanning **Convert All Characters to Lower Case**.

These settings override [Keyboard Style](#) selections.

Note: If your interface is a keyboard wedge, first scan the menu code for [Automatic Caps Lock](#) (page 16). Otherwise, your output may not be as expected.

Default = Keyboard Conversion Off.



KBDENV0.

* Keyboard Conversion Off



KBDENV1.

Convert All Characters
to Upper Case



KBDENV2.

Convert All Characters
to Lower Case

Control Character Output

This selection sends a text string instead of a control character. For example, when the control character for a carriage return is expected, the output would display [CR] instead of the ASCII code of 0D. Refer to [ASCII Conversion Chart \(Code Page 1252\)](#) on page 154. Only codes 00 through 1F are converted (the first column of the chart). *Default = Off.*

Note: *Control + ASCII Mode overrides this mode.*



KBDNPE1.

Control Character Output On



KBDNPE0.

* Control Character Output Off

Keyboard Modifiers

This modifies special keyboard features, such as CTRL+ ASCII codes and Turbo Mode.

Control + ASCII Mode On: The scanner sends key combinations for ASCII control characters for values 00-1F. Windows is the preferred mode. All keyboard country codes are supported. DOS mode is a legacy mode, and it does not support all keyboard country codes. New users should use the Windows mode. Refer to [ASCII Conversion Chart \(Code Page 1252\)](#), page 154 for CTRL+ ASCII Values.

Windows Mode Prefix/Suffix Off: The scanner sends key combinations for ASCII control characters for values 00-1F, but it does not translate any prefix or suffix information.

Default = Control + ASCII Mode Off.



KBDCAS2.
**Windows Mode Control + X
Mode On**



KBDCAS0.
*** Control + X Mode Off**



KBDCAS1.
DOS Mode Control + X Mode On



KBDCAS3.
Windows Mode Prefix/Suffix

Turbo Mode: The scanner sends characters to a terminal faster. If the terminal drops characters, do not use Turbo Mode. *Default = Off.*



KBDTMD1.
Turbo Mode On



KBDTMD0.
*** Turbo Mode Off**

Numeric Keypad Mode: Sends numeric characters as if entered from a numeric keypad. *Default = Off.*



KBDNPS1.
Numeric Keypad Mode On



KBDNPS0.
*** Numeric Keypad Mode Off**

Automatic Direct Connect Mode: This selection can be used if you have an IBM AT style terminal and the system is dropping characters. *Default = Off.*



KBDADC1.
**Automatic Direct Connect
 Mode On**



KBDADC0.
*** Automatic Direct Connect
 Mode Off**

RS232 Modifiers

RS232 Baud Rate

Baud Rate sends the data from the scanner to the terminal at the specified rate. The host terminal must be set for the same baud rate as the scanner. *Default = 115200.*



232BAD0.
300



232BAD1.
600



232BAD2.
1200



232BAD3.
2400



232BAD4.
4800



232BAD5.
9600



RS232 Word Length: Data Bits, Stop Bits, and Parity

Data Bits sets the word length at 7 or 8 bits of data per character. If an application requires only ASCII Hex characters 0 through 7F decimal (text, digits, and punctuation), select 7 data bits. For applications that require use of the full ASCII set, select 8 data bits per character. *Default = 8.*

Stop Bits sets the stop bits at 1 or 2. *Default = 1.*

Parity provides a means of checking character bit patterns for validity. *Default = None.*





232WRD5.

8 Data, 1 Stop, Parity Even



232WRD7.

7 Data, 2 Stop, Parity Odd



232WRD2.

* 8 Data, 1 Stop, Parity None



232WRD8.

8 Data, 1 Stop, Parity Odd

RS232 Receiver Time-Out

The unit stays awake to receive data until the RS232 Receiver Time-Out expires. A manual trigger resets the time-out. When an RS232 receiver is sleeping, a character may be sent to wake up the receiver and reset the time-out. A transaction on the CTS line will also wake up the receiver. The receiver takes 300 milliseconds to completely come up. Change the RS232 receiver time-out by scanning the barcode below, then scanning digits from the [Programming Chart](#), then scanning **Save**. The range is 0 to 300 seconds. *Default = 0 seconds (no time-out - always on).*



232LPT.

RS232 Receiver Time-Out

RS232 Handshaking

RS232 Handshaking allows control of data transmission from the scanner using software commands from the host device. When RTS/CTS is turned Off, no data flow control is used.

Flow Control, No Timeout: The scanner asserts RTS when it has data to send, and will wait indefinitely for CTS to be asserted by the host.

Two-Direction Flow Control: The scanner asserts RTS when it is OK for the host to transmit. The host asserts CTS when it is OK for the device to transmit.

Flow Control with Timeout: The scanner asserts RTS when it has data to send and waits for a delay (see [RS232 Timeout](#) on page 22) for CTS to be asserted by the host. If the delay time expires and CTS is not asserted, the device transmit buffer is cleared and scanning may resume. *Default = RTS/CTS Off.*



232CTS1.

Flow Control, No Timeout



232CTS2.

Two-Direction Flow Control



232CTS3.

Flow Control with Timeout



232CTS0.

*** RTS/CTS Off**

RS232 Timeout

When using Flow Control with Timeout, you must program the length of the delay you want to wait for CTS from the host. Set the length (in milliseconds) for a timeout by scanning the barcode below, then setting the timeout (from 1-5100 milliseconds) by scanning digits from the [Programming Chart](#), then scanning Save.



232DEL.

RS232 Timeout

XON/XOFF

Standard ASCII control characters can be used to tell the scanner to start sending data (XON/XOFF On) or to stop sending data (XON/XOFF Off). When the host sends the XOFF character (DC3, hex 13) to the scanner, data transmission stops. To resume transmission, the host sends the XON character (DC1, hex 11). Data transmission continues where it left off when XOFF was sent. *Default = XON/XOFF Off.*



232XON1.

XON/XOFF On



232XON0.

*** XON/XOFF Off**

ACK/NAK

After transmitting data, the scanner waits for an ACK character (hex 06) or a NAK character (hex 15) response from the host. If ACK is received, the communications cycle is completed and the scanner looks for more barcodes. If NAK is received, the last set of barcode data is retransmitted and the scanner waits for ACK/NAK again. Turn on the ACK/NAK protocol by scanning the **ACK/NAK On** barcode below. To turn off the protocol, scan **ACK/NAK Off**. *Default = ACK/NAK Off.*



Scanner to Bioptic Communication

The following settings are used to set up communication between Honeywell scanners and bioptic scanners.

Note: *The scanner's baud rate must be set to 38400 and the RS232 timeout must be set to 3000 in order to communicate with a bioptic scanner. See "RS232 Baud Rate" on page 19, and [RS232 Timeout](#) on page 22 for further information.*

Scanner-Bioptic Packet Mode

Packet Mode On must be scanned to set the scanner's format so it is compatible with a bioptic scanner. *Default = Packet Mode Off.*



Scanner-Bioptic ACK/NAK Mode

Bioptic ACK/Nak On must be scanned so the scanner will wait for an ACK or NAK from a bioptic scanner after each packet is sent. The Scanner-Bioptic ACK/NAK Timeout (below) controls how long the scanner will wait for a response. *Default = Bioptic ACK/NAK Off.*



Scanner-Bioptic ACK/NAK Timeout

This allows you to set the length (in milliseconds) for a timeout for a bioptic scanner's ACK/NAK response. Scan the barcode below, then set the timeout (from 1-30,000 milliseconds) by scanning digits from the [Programming Chart](#), then scanning **Save**. *Default = 5100.*



Power Up Beeper

The scanner can be programmed to beep when it's powered up. Scan the **Off** barcode(s) if you don't want a power up beep. *Default = Power Up Beeper On - Scanner.*



BEPPWR0.

**Power Up Beeper Off -
Scanner**



BEPPWR1.

*** Power Up Beeper On -
Scanner**

Beep on BEL Character

You may wish to force the scanner to beep upon a command sent from the host. If you scan the **Beep on BEL On** barcode below, the scanner will beep every time a BEL character is received from the host. *Default = Beep on BEL Off.*



BELBEP0.

***Beep on BEL Off**



BELBEP1.

Beep on BEL On

Good Read and Error Indicators

Beeper – Good Read

The beeper may be programmed **On** or **Off** in response to a good read. Turning this option off, only turns off the beeper response to a good read indication. All error and menu beeps are still audible. *Default = Beeper - Good Read On.*



BEPBEP0.

Beeper - Good Read Off



BEPBEP1.

*** Beeper - Good Read On**

Beeper Volume – Good Read

The beeper volume codes modify the volume of the beep the scanner emits on a good read. *Default = High.*



BEPLVL1.

Low



BEPLVL2.

Medium



BEPLVL3.

*** High**



BEPLVL0.

Off

Beeper Pitch – Good Read

The beeper pitch codes modify the pitch (frequency) of the beep the scanner emits on a good read. *Default = Medium.*



BEPFQ11600.

Low (1600 Hz)



BEPFQ12400.
* Medium (2400 Hz)



BEPFQ14200.
High (4200 Hz)

Beeper Pitch – Error

The beeper pitch codes modify the pitch (frequency) of the sound the scanner emits when there is a bad read or error. *Default = Razz.*



BEPFQ2250.
* Razz (250 Hz)



BEPFQ23250.
Medium (3250 Hz)



BEPFQ24200.
High (4200 Hz)

Beeper Duration – Good Read

The beeper duration codes modify the length of the beep the scanner emits on a good read. *Default = Normal.*



BEPBIP0.
* Normal Beep



BEPBIP1.
Short Beep

LED – Good Read

The LED indicator can be programmed **On** or **Off** in response to a good read.
Default = On.



BEPLED1.

* LED – Good Read On



BEPLED0.

LED – Good Read Off

Number of Beeps – Good Read

The number of beeps of a good read can be programmed from 1 - 9. The same number of beeps will be applied to the beeper and LED in response to a good read. For example, if you program this option to have five beeps, there will be five beeps and five LED flashes in response to a good read. The beeps and LED flashes are in sync with one another. To change the number of beeps, scan the barcode below and then scan a digit (1-9) barcode and the **Save** barcode on the [Programming Chart](#). *Default = 1.*



BEPRPT.

Number of Good Read Beeps/LED Flashes

Number of Beeps – Error

The number of beeps and LED flashes emitted by the scanner for a bad read or error can be programmed from 1 - 9. For example, if you program this option to have five error beeps, there will be five error beeps and five LED flashes in response to an error. To change the number of error beeps, scan the barcode below and then scan a digit (1-9) barcode and the **Save** barcode on the [Programming Chart](#). *Default = 1.*



BEPERR.

Number of Error Beeps/LED Flashes

Good Read Delay

This sets the minimum amount of time before the scanner can read another barcode. *Default = 0 ms (No Delay).*



DLYGRD0.

*** No Delay**



DLYGRD500.

Short Delay (500 ms)



DLYGRD1000.

Medium Delay (1,000 ms)



DLYGRD1500.

Long Delay (1,500 ms)

User-Specified Good Read Delay

If you want to set your own length for the good read delay, scan the barcode below, then set the delay (from 0-30,000 milliseconds) by scanning digits from the [Programming Chart](#), then scanning **Save**.



DLYGRD.

User-Specified Good Read Delay

IR Trigger Mode

When in IR Trigger mode, the scanner uses an infrared (IR) sensor to detect objects and start to scan and decode barcode symbols. *Default = IR Trigger Mode.*



TRGMOD0.

IR Trigger Mode

LED Illumination

If you wish to set the illumination LED brightness, scan one of the barcodes below. This sets the LED illumination for the scanner. *Default = High.*

Note: *The LEDs are like a flash on a camera. The lower the ambient light in the room, the brighter the LEDs need to be so the scanner can “see” the barcodes.*



PWRNOL0.

Low



PWRNOL1.

Medium



PWRNOL2.

*** High**

Serial Trigger Mode

You can activate the scanner by using a serial trigger command (see [Trigger Commands](#) on page 124). When in serial mode, the scanner scans until a barcode has been read or until the deactivate command is sent. The scanner can also be set to turn itself off after a specified time has elapsed (see [Read Time-Out](#), which follows).

Read Time-Out

Use this selection to set a time-out (in milliseconds) of the scanner’s trigger when using serial commands to trigger the scanner. Once the scanner has timed out, you can activate the scanner either by pressing the trigger or using a serial trigger command. After scanning the **Read Time-Out** barcode, set the time-out duration (from 0-300,000 milliseconds) by scanning digits on the [Programming Chart](#), then scanning **Save**. *Default = 30,000 ms.*



TRGSTO.

Read Time-Out

Presentation Mode

Presentation Mode uses ambient light to detect barcodes. The LED dims until a barcode is presented to the scanner, then the LED brightens to read the code. If the light level in the room is not high enough, Presentation Mode may not work properly.

Scan the following barcode to program your scanner for Presentation Mode.



TRGMOD3.

Presentation Mode

Presentation Centering

Use Presentation Centering to narrow the scanner's field of view when it is in the stand to make sure the scanner reads only those barcodes intended by the user. For instance, if multiple codes are placed closely together, Presentation Centering will insure that only the desired codes are read.

If a barcode is not touched by a predefined window, it will not be decoded or output by the scanner. If Presentation Centering is turned on by scanning **Presentation Centering On**, the scanner only reads codes that pass through the centering window you specify using the **Top of Presentation Centering Window**, **Bottom of Presentation Centering Window**, **Left**, and **Right of Presentation Centering Window** barcodes.

In the example below, the white box is the centering window. The centering window has been set to 20% left, 30% right, 8% top, and 25% bottom. Since barcode 1 passes through the centering window, it will be read. barcode 2 does not pass through the centering window, so it will not be read.

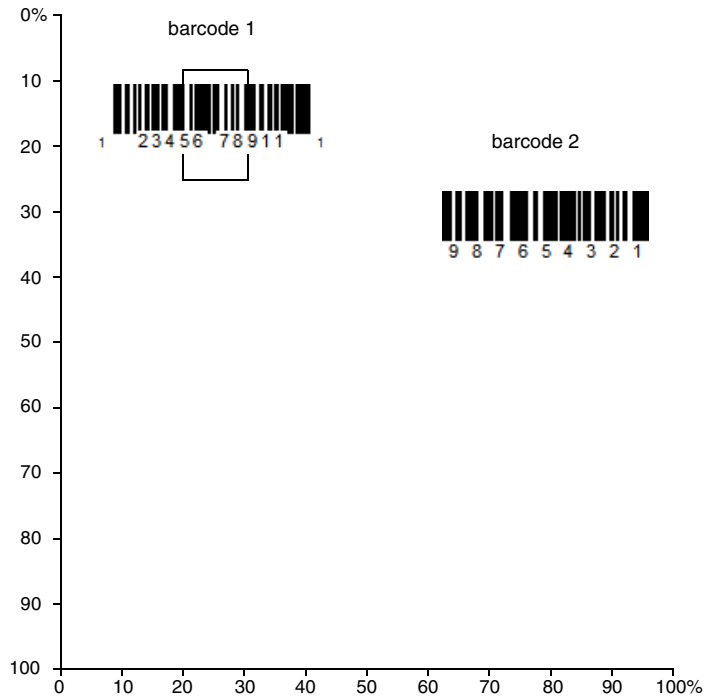

Note: A barcode needs only to be touched by the centering window in order to be read. It does not need to pass completely through the centering window.

Scan **Presentation Centering On**, then scan one of the following barcodes to change the top, bottom, left, or right of the centering window. Then scan the percent you want to shift the centering window using digits on the [Programming Chart](#). Scan **Save**. Default Presentation Centering = 40% for Top and Left, 60% for Bottom and Right.



PDCWIN1.

Presentation Centering On



PDCWIND.

*** Presentation Centering Off**



PDCTOP.

Top of Presentation Centering Window



PDCLFT.
**Left of
 Presentation Centering
 Window**



PDCBOT.
**Bottom of Presentation
 Centering Window**



PDCRGT.
**Right of Presentation
 Centering Window**

Streaming Presentation Mode

When in Streaming Presentation Mode, the scanner's illumination remains on all the time to continuously search for barcodes. Two modes are available: Normal and Enhanced. Normal mode offers good scan speed and the longest working range (depth of field). Enhanced mode will give you the highest possible scan speed but slightly less range than Normal mode. Enhanced mode is best used when you require a very fast scan speed and don't require a long working range. *Default Streaming Presentation Mode = Normal.*



TRGMOD8;PDCEMX500;PDCGMX8.
***Streaming Presentation Mode -
 Normal**



TRGMOD8;PDCEMX150;PDCGMX12.
**Streaming Presentation Mode -
 Enhanced**

Read Mode

Read mode allows you to prioritize barcode by the type of media. When in Paper and Screen mode, the scanner will give you a balanced scan speed on printed barcodes, mobile phone screens or other digital barcodes. Paper-Only gives the highest possible scan speed on printed barcodes but slightly less scan speed on

mobile phone screen or other digital barcodes. And Screen Only gives the highest possible scan speed on mobile phone screens or other digital barcodes but slightly less scan speed on printed barcodes. *Default Read Mode = Paper and Screen.*



ILLMOD1.

***Paper and Screen Read Mode**



ILLMOD0.

Paper Only Read Mode



ILLMOD2.

Screen Only Read Mode

Poor Quality Codes

Poor Quality 1D Codes

This setting improves the scanner's ability to read damaged or badly printed linear barcodes. When **Poor Quality 1D Reading On** is scanned, poor quality linear barcode reading is improved, but the scanner's snappiness is decreased, making it less aggressive when reading good quality barcodes. This setting does not affect 2D barcode reading. *Default = Poor Quality 1D Reading Off.*



DECLD1.

Poor Quality 1D Reading On



DECLD0.

*** Poor Quality 1D Reading Off**

Poor Quality PDF Codes

This setting improves the scanner's ability to read damaged or badly printed PDF codes by combining information from multiple images. It is useful when a complete barcode cannot be seen in one image. This setting does not affect 1D barcode reading. *Default = Poor Quality PDF Reading Off.*



PDFXPR10.

Poor Quality PDF Reading On



PDFXPR0.

*** Poor Quality PDF Reading**

Reread Delay

This sets the time period before the scanner can read the *same* barcode a second time. Setting a reread delay protects against accidental rereads of the same barcode. Longer delays are effective in minimizing accidental rereads. Use shorter delays in applications where repetitive barcode scanning is required. Reread Delay only works when in [Presentation Mode](#). *Default = Medium.*



DLYRRD500.

Short (500 ms)



DLYRRD750.

*** Medium (750 ms)**



DLYRRD1000.

Long (1000 ms)



DLYRRD2000.

Extra Long (2000 ms)

User-Specified Reread Delay

If you want to set your own length for the reread delay, scan the barcode below, then set the delay (from 0-30,000 milliseconds) by scanning digits from the [Programming Chart](#), then scanning **Save**.



DLYRRD.

User-Specified Reread Delay

2D Reread Delay

Sometimes 2D barcodes can take longer to read than other barcodes. If you wish to set a separate Reread Delay for 2D barcodes, scan one of the programming codes that follows. **2D Reread Delay Off** indicates that the time set for [Reread Delay](#) is used for both 1D and 2D barcodes. *Default = 2D Reread Delay Off.*



DLY2RR0.

*** 2D Reread Delay Off**



DLY2RR1000.

Short (1000ms)



DLY2RR2000.

Medium (2000ms)



DLY2RR3000.

Long (3000ms)



DLY2RR4000.

Extra Long (4000ms)

Character Activation Mode

You may use a character sent from the host to trigger the scanner to begin scanning. When the activation character is received, the scanner continues scanning until either the [Character Activation Timeout](#), the deactivation character is received (see [Deactivation Character](#)), or a barcode is transmitted. Scan the

following **On** barcode to use character activation, then use Activation Character (following) to select the character you will send from the host to start scanning. *Default = Off.*



Activation Character

This sets the character used to trigger scanning when using Character Activation Mode. On the [ASCII Conversion Chart \(Code Page 1252\)](#), find the hex value that represents the character you want to use to trigger scanning. Scan the following barcode, then use the [Programming Chart](#) to read the alphanumeric combination that represents that ASCII character. Scan **Save** to finish.



End Character Activation After Good Read

After a barcode is successfully detected and read from the scanner, the aimer can be programmed either to remain on and scanning, or to turn off. When **End Character Activation After Good Read** is enabled, the aimer turns off and stops scanning after a good read. If you scan **Do Not End Character Activation After Good Read**, the aimer remains on after a good read. *Default = End Character Activation After Good Read.*



Character Activation Timeout

You can set a timeout for the length of time the aimer remains on and attempting to decode barcodes when using [Character Activation Mode](#). Set the length (in milliseconds) for a timeout by scanning the following barcode, then setting the timeout (from 1-65535 milliseconds) by scanning digits from the [Programming Chart](#), then scanning **Save**. *Default = 5000 ms.*



Character Deactivation Mode

If you have sent a character from the host to trigger the scanner to begin scanning, you can also send a deactivation character to stop scanning. Scan the following **On** barcode to use character deactivation, then use [Deactivation Character](#) to select the character you will send from the host to terminate scanning. *Default = Off.*



Deactivation Character

This sets the character used to terminate scanning when using Character Deactivation Mode. On the [ASCII Conversion Chart \(Code Page 1252\)](#), find the hex value that represents the character you want to use to terminate scanning. Scan the following barcode, then use the [Programming Chart](#) to read the alphanumeric combination that represents that ASCII character. Scan **Save** to finish.



Illumination Lights

If you want the illumination lights on while reading a barcode, scan the **Lights On** barcode, below. However, if you want to turn just the lights off, scan the **Lights Off** barcode. *Default = Lights On.*



SCNLED1.
* Lights On



SCNLED0.
Lights Off

No Read

With No Read turned On, the scanner notifies you if a code cannot be read. If using an EZConfig for Scanning Tool Scan Data Window (see page 118), an “NR” appears when a code cannot be read. If No Read is turned Off, the “NR” will not appear.

Default = Off.



SHWNRD1.
On



SHWNRD0.
* Off

If you want a different notation than “NR,” for example, “Error,” or “Bad Code,” you can edit the output message (see [Data Format](#)). The hex code for the No Read symbol is **9C**.

Video Reverse

Video Reverse is used to allow the scanner to read barcodes that are inverted. The **Video Reverse Off** barcode below is an example of this type of barcode. Scan **Video Reverse Only** to read *only* inverted barcodes. Scan **Video Reverse and Standard barcodes** to read both types of codes.

Note: After scanning **Video Reverse Only**, menu barcodes cannot be read. You must scan **Video Reverse Off** or **Video Reverse and Standard barcodes** in order to read menu barcodes.

Note: Images downloaded from the unit are not reversed. This is a setting for decoding only.



VIDREV1.
Video Reverse Only



* Video Reverse Off

Working Orientation

Some barcodes are direction-sensitive. For example, KIX codes can misread when scanned sideways or upside down. Use the working orientation settings if your direction-sensitive codes will not usually be presented upright to the scanner.
Default = Upright.

Upright:



Upside Down:

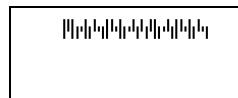

Vertical, Top to Bottom:
(Rotate CW 90°)

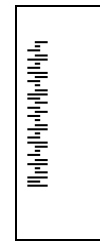

Vertical, Bottom to Top:
(Rotate CCW 90°)





ROTATN3.

Vertical, Top to Bottom

Prefix/Suffix Overview

When a barcode is scanned, additional information is sent to the host computer along with the barcode data. This group of barcode data and additional, user-defined data is called a “message string.” The selections in this section are used to build the user-defined data into the message string.

Prefix and Suffix characters are data characters that can be sent before and after scanned data. You can specify if they should be sent with all symbologies, or only with specific symbologies. The following illustration shows the breakdown of a message string:

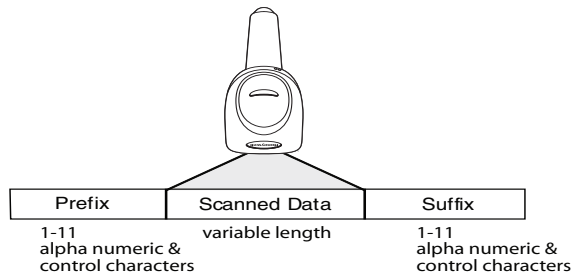

Points to Keep In Mind

- It is not necessary to build a message string. The selections in this chapter are only used if you wish to alter the default settings. *Default prefix = None. Default suffix = None.*
- A prefix or suffix may be added or cleared from one symbology or all symbologies.
- You can add any prefix or suffix from the [ASCII Conversion Chart \(Code Page 1252\)](#), plus Code I.D. and AIM I.D.
- You can string together several entries for several symbologies at one time.
- Enter prefixes and suffixes in the order in which you want them to appear on the output.

- When setting up for specific symbologies (as opposed to all symbologies), the specific symbology ID value counts as an added prefix or suffix character.
- The maximum size of a prefix or suffix configuration is 200 characters, which includes header information.

To Add a Prefix or Suffix:

- Step 1. Scan the **Add Prefix** or **Add Suffix** symbol (page 45).
- Step 2. Determine the 2 digit Hex value from the Symbology Chart (included in the [Symbology Charts](#)) for the symbology to which you want to apply the prefix or suffix. For example, for Code 128, Code ID is “j” and Hex ID is “6A”.
- Step 3. Scan the 2 hex digits from the [Programming Chart](#) or scan **9, 9** for all symbologies.

To add the Code I.D., scan **5, C, 8, 0**.

To add the AIM I.D., scan **5, C, 8, 1**.

To add the serial number, scan **5, C, 8, 8**.

To add a backslash (\), scan **5, C, 5, C**.

Note: When adding a backslash (\), you must scan 5C twice – once to create the leading backslash and then to create the backslash itself.

- Step 4. Repeat Steps 2 and 3 for every prefix or suffix character.
- Step 5. Scan **Save** to exit and save, or scan **Discard** to exit without saving.

Repeat the steps above to add a prefix or suffix for another symbology.

Example: Add a Tab Suffix to All Symbologies

- Step 1. Scan **Add Suffix**.
- Step 2. Scan **9, 9** from the [Programming Chart](#) to apply this suffix to all symbologies.
- Step 3. Scan **0, 9** from the [Programming Chart](#). This corresponds with the hex value for a horizontal tab, shown in the [ASCII Conversion Chart \(Code Page 1252\)](#), beginning on page 154.
- Step 4. Scan **Save**, or scan **Discard** to exit without saving.

Clear One or All Prefixes or Suffixes

You can clear a single prefix or suffix, or clear all prefixes/suffixes for a symbology. If you have been entering prefixes and suffixes for single symbologies, you can use **Clear One Prefix (Suffix)** to delete a specific character from a symbology. When you **Clear All Prefixes (Suffixes)**, all the prefixes or suffixes for a symbology are deleted.

- Step 1. Scan the **Clear One Prefix** or **Clear One Suffix** symbol.
- Step 2. Determine the 2 digit Hex value from the [Symbology Charts](#) for the symbology from which you want to clear the prefix or suffix.
- Step 3. Scan the 2 digit hex value from the [Programming Chart](#) or scan **9, 9** for all symbologies.

Your change is automatically saved.

Add a Carriage Return Suffix to All Symbologies

Scan the following barcode if you wish to add a carriage return suffix to all symbologies at once. This action first clears all current suffixes, then programs a carriage return suffix for all symbologies.



Prefix Selections



Suffix Selections





SUFCA2.
Clear All Suffixes

Function Code Transmit

When this selection is enabled and function codes are contained within the scanned data, the scanner transmits the function code to the terminal. Charts of these function codes are provided in the [ASCII Conversion Chart \(Code Page 1252\)](#). When the scanner is in keyboard wedge mode, the scan code is converted to a key code before it is transmitted. *Default = Enable.*



RMVFNC0.
* Enable



RMVFNC1.
Disable

Intercharacter, Interfunction, and Intermessage Delays

Some terminals drop information (characters) if data comes through too quickly. Intercharacter, interfunction, and intermessage delays slow the transmission of data, increasing data integrity.

Intercharacter Delay

An intercharacter delay of up to 5000 milliseconds (in 5ms increments) may be placed between the transmission of each character of scanned data. Scan the **Intercharacter Delay** barcode below, then scan the number of 5ms delays, and the **Save** barcode using the [Programming Chart](#).

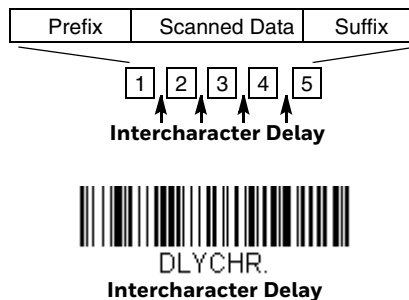

To remove this delay, scan the Intercharacter Delay barcode, then set the number of delays to **0**. Scan the **Save** barcode using the [Programming Chart](#).

Note: *Intercharacter delays are not supported in USB serial emulation.*

User Specified Intercharacter Delay

An intercharacter delay of up to 5000 milliseconds (in 5ms increments) may be placed after the transmission of a particular character of scanned data. Scan the **Delay Length** barcode below, then scan the number of 5ms delays, and the **Save** barcode using the [Programming Chart](#).

Next, scan the **Character to Trigger Delay** barcode, then the 2-digit hex value for a printable character to trigger the delay. See [ISO 2022/ISO 646 Character Replacements](#) on page A-158..



To remove this delay, scan the **Delay Length** barcode, and set the number of delays to **0**. Scan the **Save** barcode using the [Programming Chart](#).

Interfunction Delay

An interfunction delay of up to 5000 milliseconds (in 5ms increments) may be placed between the transmission of each segment of the message string. Scan the **Interfunction Delay** barcode below, then scan the number of 5ms delays, and the **Save** barcode using the [Programming Chart](#).

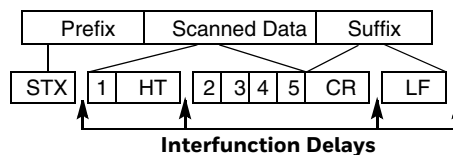

To remove this delay, scan the **Interfunction Delay** barcode, then set the number of delays to **0**. Scan the **Save** barcode using the [Programming Chart](#).

Intermessage Delay

An intermessage delay of up to 5000 milliseconds (in 5ms increments) may be placed between each scan transmission. Scan the **Intermessage Delay** barcode below, then scan the number of 5ms delays, and the **Save** barcode using the [Programming Chart](#).

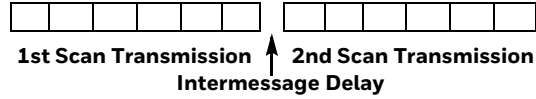

DLYMSG.
Intermesage Delay

To remove this delay, scan the **Intermesage Delay** barcode, then set the number of delays to **0**. Scan the **Save** barcode using the [Programming Chart](#).

Data Format Editor Introduction

You may use the Data Format Editor to change the scanner's output. For example, you can use the Data Format Editor to insert characters at certain points in barcode data as it is scanned. The selections in the following pages are used only if you wish to alter the output. *Default Data Format setting = None.*

Normally, when you scan a barcode, it gets outputted automatically; however when you create a format, you must use a "send" command [Send Commands](#) within the format program to output data.

Multiple formats may be programmed into the scanner. They are stacked in the order in which they are entered. However, the following list presents the order in which formats are applied:

1. Specific Terminal ID, Actual Code ID, Actual Length
2. Specific Terminal ID, Actual Code ID, Universal Length
3. Specific Terminal ID, Universal Code ID, Actual Length
4. Specific Terminal ID, Universal Code ID, Universal Length
5. Universal Terminal ID, Actual Code ID, Actual Length
6. Universal Terminal ID, Actual Code ID, Universal Length
7. Universal Terminal ID, Universal Code ID, Actual Length
8. Universal Terminal ID, Universal Code ID, Universal Length

The maximum size of a data format configuration is 2000 bytes, which includes header information.

If you have changed data format settings, and wish to clear all formats and return to the factory defaults, scan the **Default Data Format** code below.



DFMDF3.

* **Default Data Format**

Show Data Format

Scan the barcode below to show current data format settings.



DFMBK3?

Data Format Settings

Add a Data Format

- Step 1. Scan the [Enter Data Format](#) symbol.
- Step 2. Select **Primary/Alternate** Format
Determine if this will be your primary data format, or one of 3 alternate formats. This allows you to save a total of 4 different data formats. To program your primary format, scan **0** using the [Programming Chart](#). If you are programming an alternate format, scan **1**, **2**, or **3**, depending on which alternate format you are programming. (See [Primary/Alternate Data Formats](#) for further information.)
- Step 3. **Terminal Type**
Refer to [Terminal ID Table](#) and locate the Terminal ID number for your PC. Scan three numeric barcodes on the [Programming Chart](#) to program the scanner for your terminal ID (you must enter 3 digits). For example, scan **0 0 3** for an AT wedge.

Note: **099** indicates all terminal types.

- Step 4. **Code I.D.**
In the [Symbology Charts](#), find the symbology to which you want to apply the data format. Locate the Hex value for that symbology and scan the 2 digit hex value from the [Programming Chart](#).

Note: If you are creating a data format for Batch Mode Quantity, use **35** for the Code I.D.

- Step 5. **Length**
Specify what length (up to 9999 characters) of data will be acceptable for this symbology. Scan the four digit data length from the [Programming Chart](#). (Note: 50 characters is entered as 0050. 9999 is a universal number, indicating all lengths.)

Note: **9999** indicates all lengths.

- Step 6. **Editor Commands**
Refer to [Data Format Editor Commands](#). Scan the symbols that represent the command you want to enter.
- Step 7. Scan **Save** to save your data format, or **Discard** to exit without saving your changes.



DFMBK3.

Enter Data Format



Other Programming Selections

- **Clear One Data Format**
This deletes one data format for one symbology. If you are clearing the primary format, scan **0** from the [Programming Chart](#). If you are clearing an alternate format, scan **1**, **2**, or **3**, depending on the format you are clearing. Scan the Terminal Type and Code I.D. (see [Symbology Charts](#)), and the barcode data length for the specific data format that you want to delete. All other formats remain unaffected.
- **Clear all Data Formats**
This clears all data formats.
- **Save** to exit and save your data format changes.
- **Discard** to exit without saving any data format changes.



Terminal ID Table

Terminal	Model(s)	Terminal ID
USB	PC keyboard (HID)	124
	Mac Keyboard	125
	PC Keyboard (Japanese)	134
	Serial (COM driver required)	130
	HID POS	131
	USB SurePOS Handheld	128
	USB SurePOS Tabletop	129
Serial	RS232 TTL	000
	RS232 True	000

Data Format Editor Commands

When working with the Data Format Editor, a virtual cursor is moved along your input data string. The following commands are used to both move this cursor to different positions, and to select, replace, and insert data into the final output.

Send Commands

Send all characters

- F1** Include in the output message all of the characters from the input message, starting from current cursor position, followed by an insert character. *Syntax = F1xx* where xx stands for the insert character's hex value for its ASCII code. Refer to the [ASCII Conversion Chart \(Code Page 1252\)](#) for decimal, hex and character codes.

Send a number of characters

- F2** Include in the output message a number of characters followed by an insert character. Start from the current cursor position and continue for "nn" characters or through the last character in the input message, followed by character "xx." *Syntax = F2nnxx* where nn stands for the numeric value (00-99) for the number of characters, and xx stands for the insert character's hex value for its ASCII code. Refer to the [ASCII Conversion Chart \(Code Page 1252\)](#), beginning on page 154 for decimal, hex and character codes.

F2 Example: Send a number of characters



Send the first 10 characters from the barcode above, followed by a carriage return.
Command string: F2100D

F2 is the “Send a number of characters” command

10 is the number of characters to send

0D is the hex value for a CR

The data is output as: **1234567890**

F2 and F1 Example: Split characters into 2 lines

Send the first 10 characters from the barcode above, followed by a carriage return, followed by the rest of the characters.

Command string: **F2100DF10D**

F2 is the “Send a number of characters” command

10 is the number of characters to send for the first line

0D is the hex value for a CR

F1 is the “Send all characters” command

0D is the hex value for a CR

The data is output as:

1234567890

ABCDEFGHIJ

<CR>

Send all characters up to a particular character

F3 Include in the output message all characters from the input message, starting with the character at the current cursor position and continuing to, but not including, the search character “ss,” followed by an insert character. The cursor is moved forward to the “ss” character. *Syntax = F3ssxx* where ss stands for the search character’s hex value for its ASCII code, and xx stands for the insert character’s hex value for its ASCII code.

Refer to the [ASCII Conversion Chart \(Code Page 1252\)](#) for decimal, hex and character codes.

F3 Example: Send all characters up to a particular character



Using the barcode above, send all characters up to but not including “D,” followed by a carriage return.

Command string: **F3440D**

F3 is the “Send all characters up to a particular character” command

44 is the hex value for a 'D’

0D is the hex value for a CR

The data is output as:

1234567890ABC

<CR>

Send all but the last characters

- E9** Include in the output message all but the last “nn” characters, starting from the current cursor position. The cursor is moved forward to one position past the last input message character included. *Syntax = E9nn* where nn stands for the numeric value (00-99) for the number of characters that will not be sent at the end of the message.

Insert a character multiple times

- F4** Send “xx” character “nn” times in the output message, leaving the cursor in the current position. *Syntax = F4xxnn* where xx stands for the insert character’s hex value for its ASCII code, and nn is the numeric value (00-99) for the number of times it should be sent.

Refer to the [ASCII Conversion Chart \(Code Page 1252\)](#), beginning on page 154 for decimal, hex and character codes.

E9 and F4 Example: Send all but the last characters, followed by 2 tabs



Send all characters except for the last 8 from the barcode above, followed by 2 tabs.

Command string: **E908F40902**

E9 is the “Send all but the last characters” command

08 is the number of characters at the end to ignore

F4 is the “Insert a character multiple times” command

09 is the hex value for a horizontal tab

02 is the number of times the tab character is sent

The data is output as: **1234567890AB <tab><tab>**

Move Commands

Move the cursor forward a number of characters

F5 Move the cursor ahead “nn” characters from current cursor position.
Syntax = F5nn where nn is the numeric value (00-99) for the number of characters the cursor should be moved ahead.

F5 Example: Move the cursor forward and send the data



Move the cursor forward 3 characters, then send the rest of the barcode data from the barcode above. End with a carriage return.

Command string: **F503F10D**

F5 is the “Move the cursor forward a number of characters” command

03 is the number of characters to move the cursor

F1 is the “Send all characters” command

0D is the hex value for a CR

The data is output as:

4567890ABCDEFGHIJ

<CR>

Move the cursor backward a number of characters

F6 Move the cursor back “nn” characters from current cursor position.
Syntax = F6nn where nn is the numeric value (00-99) for the number of characters the cursor should be moved back.

Move the cursor to the beginning

F7 Move the cursor to the first character in the input message. *Syntax = F7.*

FE and F7 Example: Manipulate barcodes that begin with a 1



Search for barcodes that begin with a 1. If a barcode matches, move the cursor back to the beginning of the data and send 6 characters followed by a carriage return. Using the barcode above:

Command string: **FE31F7F2060D**

FE is the “Compare characters” command

31 is the hex value for 1

F7 is the “Move the cursor to the beginning” command

F2 is the “Send a number of characters” command

06 is the number of characters to send

0D is the hex value for a CR

The data is output as:

123456

<CR>

Move the cursor to the end

EA Move the cursor to the last character in the input message. *Syntax = EA.*

Search Commands

Search forward for a character

F8 Search the input message forward for “xx” character from the current cursor position, leaving the cursor pointing to the “xx” character. *Syntax = F8xx* where xx stands for the search character’s hex value for its ASCII code. Refer to the [ASCII Conversion Chart \(Code Page 1252\)](#), beginning on page 154 for decimal, hex and character codes.

F8 Example: Send barcode data that starts after a particular character



Search for the letter “D” in barcodes and send all the data that follows, including the “D.” Using the barcode above:

Command string: **F844F10D**

F8 is the “Search forward for a character” command

44 is the hex value for “D”

F1 is the “Send all characters” command

0D is the hex value for a CR

The data is output as:

DEFGHIJ

<CR>

Search backward for a character

- F9** Search the input message backward for “xx” character from the current cursor position, leaving the cursor pointing to the “xx” character. *Syntax = F9xx* where xx stands for the search character’s hex value for its ASCII code. Refer to the [ASCII Conversion Chart \(Code Page 1252\)](#), beginning on page 154 for decimal, hex and character codes.

Search forward for a non-matching character

- E6** Search the input message forward for the first non-“xx” character from the current cursor position, leaving the cursor pointing to the non-“xx” character. *Syntax = E6xx* where xx stands for the search character’s hex value for its ASCII code. Refer to the [ASCII Conversion Chart \(Code Page 1252\)](#), beginning on page 154 for decimal, hex and character codes.

E6 Example: Remove zeros at the beginning of barcode data



This example shows a barcode that has been zero filled. You may want to ignore the zeroes and send all the data that follows. E6 searches forward for the first character that is not zero, then sends all the data after, followed by a carriage return. Using the barcode above:

Command string: **E630F10D**

E6 is the “Search forward for a non-matching character” command

30 is the hex value for 0

F1 is the “Send all characters” command

0D is the hex value for a CR

The data is output as:

37692
<CR>

Search backward for a non-matching character

- E7** Search the input message backward for the first non-“xx” character from the current cursor position, leaving the cursor pointing to the non-“xx” character. *Syntax = E7xx* where xx stands for the search character’s hex value for its ASCII code. Refer to the [ASCII Conversion Chart \(Code Page 1252\)](#), beginning on page 154 for decimal, hex and character codes.

Miscellaneous Commands

Suppress characters

FB Suppress all occurrences of up to 15 different characters, starting at the current cursor position, as the cursor is advanced by other commands. When the FC command is encountered, the suppress function is terminated. The cursor is not moved by the FB command.

Syntax = FBnnxxyy ..zz where nn is a count of the number of suppressed characters in the list, and xxyy .. zz is the list of characters to be suppressed.

FB Example: Remove spaces in barcode data



This example shows a barcode that has spaces in the data. You may want to remove the spaces before sending the data. Using the barcode above:

Command string: **FB0120F10D**

FB is the “Suppress characters” command

01 is the number of character types to be suppressed

20 is the hex value for a space

F1 is the “Send all characters” command

0D is the hex value for a CR

The data is output as:

34567890

<CR>

Stop suppressing characters

FC Disables suppress filter and clear all suppressed characters. Syntax = FC.

Replace characters

E4 Replaces up to 15 characters in the output message, without moving the cursor. Replacement continues until the E5 command is encountered. Syntax = E4nnxx₁xx₂yy₁yy₂...zz₁zz₂ where nn is the total count of the number of characters in the list (characters to be replaced plus replacement characters); xx₁ defines characters to be replaced and xx₂ defines replacement characters, continuing through zz₁ and zz₂.

E4 Example: Replace zeros with CRs in barcode data



If the barcode has characters that the host application does not want included, you can use the E4 command to replace those characters with something else. In this example, you will replace the zeroes in the barcode above with carriage returns.

Command string: **E402300DF10D**

E4 is the “Replace characters” command

02 is the total count of characters to be replaced, plus the replacement characters (0 is replaced by CR, so total characters = 2)

30 is the hex value for 0

0D is the hex value for a CR (the character that will replace the 0)

F1 is the “Send all characters” command

0D is the hex value for a CR

The data is output as:

1234

5678

ABC

<CR>

Stop replacing characters

E5 Terminates character replacement. *Syntax = E5.*

Compare characters

FE Compare the character in the current cursor position to the character “xx.” If characters are equal, move the cursor forward one position. *Syntax = FExx* where xx stands for the comparison character’s hex value for its ASCII code.

Refer to the [ASCII Conversion Chart \(Code Page 1252\)](#), beginning on page 154 for decimal, hex and character codes.

Check for a number

EC Check to make sure there is an ASCII number at the current cursor position. The format is aborted if the character is not numeric.

EC Example: Only output the data if the barcode begins with a number

If you want only data from barcodes that begin with a number, you can use EC to check for the number.

Command string: **ECF10D**

EC is the “Check for a number” command

F1 is the “Send all characters” command

0D is the hex value for a CR

If this barcode is read,  the next data format, if there is one, will be used on the data. If there is no other format, the format fails and the raw data is output as **AB1234**.

If this barcode is read:  the data is output as:

1234AB
<CR>

Check for non-numeric character

ED Check to make sure there is a non-numeric ASCII character at the current cursor position. The format is aborted if the character is numeric.

ED Example: Only output the data if the barcode begins with a letter

If you want only data from barcodes that begin with a letter, you can use ED to check for the letter.

Command string: **EDF10D**

ED is the “Check for a non-numeric character” command

F1 is the “Send all characters” command

0D is the hex value for a CR

If this barcode is read,  the next data format, if there is one, will be used on this data. If there is no other format, the format fails and the raw data is output as **1234AB**.

If this barcode is read:  the data is output as:

AB1234
<CR>

Insert a delay

EF Inserts a delay of up to 49,995 milliseconds (in multiples of 5), starting from the current cursor position. Syntax = EFnnnn where nnnn stands for the delay in 5ms increments, up to 9999. This command can only be used with keyboard emulation.

Data Formatter

When Data Formatter is turned **Off**, the barcode data is output to the host as read, including prefixes and suffixes.



You may wish to require the data to conform to a data format you have created and saved. The following settings can be applied to your data format:

- **Data Formatter On, Not Required, Keep Prefix/Suffix**
Scanned data is modified according to your data format, and prefixes and suffixes are transmitted.
- **Data Format Required, Keep Prefix/Suffix**
Scanned data is modified according to your data format, and prefixes and suffixes are transmitted. Any data that does not match your data format requirements generates an error tone and the data in that barcode is not transmitted.

Default = Data Formatter On, Not Required, Keep Prefix/Suffix.



Primary/Alternate Data Formats

You can save up to four data formats, and switch between these formats. Your primary data format is saved under **0**. Your other three formats are saved under **1**, **2**, and **3**. To set your device to use one of these formats, scan one of the barcodes below.





ALTFNM2.
Data Format 2



ALTFNM1.
Data Format 1



ALTFNM3.
Data Format 3

SYMBOLOLOGIES

This programming section contains the following menu selections. Refer to [Chapter 8](#) for settings and defaults.

- All Symbolologies
- Aztec Code
- China Post (Hong Kong 2 of 5)
- Chinese Sensible (Han Xin) Code
- Codabar
- Codablock A
- Codablock F
- Code 11
- Code 128
- Code 32 Pharmaceutical (PARAF)
- Code 39
- Code 93
- Data Matrix
- EAN/JAN-13
- EAN/JAN-8
- GS1 Composite Codes
- GS1 DataBar Expanded
- GS1 DataBar Limited
- GS1 DataBar Omnidirectional
- GS1 Emulation
- GS1-128
- Interleaved 2 of 5
- Korea Post On/Off
- Matrix 2 of 5
- MaxiCode
- MicroPDF417
- MSI
- NEC 2 of 5
- Postal Codes - 2D
- Postal Codes - Linear
- PDF417
- GS1 DataBar Omnidirectional
- QR Code
- Straight 2 of 5 IATA (two-bar start/stop)
- Straight 2 of 5 Industrial (three-bar start/stop)
- TCIF Linked Code 39 (TLC39)
- •UPC-A
- UPC-A
- UPC-A/EAN-13 with Extended Coupon Code
- UPC-E0
- UPC-E1

All Symbologies

For best scanner performance, we recommend you only enable the symbologies that you need. Scan **All Symbologies Off** to disable all symbologies, then enable the symbologies you need by scanning the **On** barcode for each symbology.



If you want to decode all the symbologies allowable for your scanner, scan the *All Symbologies On* code. If on the other hand, you want to decode only a particular symbology, scan All Symbologies Off followed by the On symbol for that particular symbology.

Note: *All Symbologies On should only be used when needed (or you are instructed to do so) and may result in slower performance.*



Note: *When All Symbologies On is scanned, 2D Postal Codes are not enabled. 2D Postal Codes must be enabled separately.*

Message Length Description

You are able to set the valid reading length of some of the barcode symbologies. You may wish to set the same value for minimum and maximum length to force the scanner to read fixed length barcode data. This helps reduce the chances of a misread.

Example: Decode only those barcodes with a count of 9-20 characters.
Min. length = 09Max. length = 20

Example: Decode only those barcodes with a count of 15 characters.
Min. length = 15Max. length = 15

For a value other than the minimum and maximum message length defaults, scan the barcodes included in the explanation of the symbology, then scan the digit value of the message length and **Save** barcodes on the [Programming Chart](#). The minimum and maximum lengths and the defaults are included with the respective symbologies.

Codabar

<Default All Codabar Settings>



Codabar On/Off



Codabar Start / Stop Characters

Start/Stop characters identify the leading and trailing ends of the barcode. You may either transmit, or not transmit Start/Stop characters. *Default = Don't Transmit.*



Codabar Check Character

Codabar check characters are created using different "modulos." You can program the scanner to read only Codabar barcodes with Modulo 16 check characters. *Default = No Check Character.*

No Check Character indicates that the scanner reads and transmits barcode data with or without a check character.

When Check Character is set to **Validate and Transmit**, the scanner will only read Codabar barcodes printed with a check character, and will transmit this character at the end of the scanned data.

When Check Character is set to **Validate, but Don't Transmit**, the unit will only read Codabar barcodes printed *with* a check character, but will not transmit the check character with the scanned data.



Codabar Concatenation

Codabar supports symbol concatenation. When you enable concatenation, the scanner looks for a Codabar symbol having a “D” start character, adjacent to a symbol having a “D” stop character. In this case the two messages are concatenated into one with the “D” characters omitted.



Select **Require** to prevent the scanner from decoding a single “D” Codabar symbol without its companion. This selection has no effect on Codabar symbols without Stop/Start D characters.



Codabar Message Length

Scan the barcodes below to change the message length. Refer to [Message Length Description](#) (page 64) for additional information. Minimum and Maximum lengths = 2-60. Minimum Default = 4, Maximum Default = 60.



Code 39

< Default All Code 39 Settings >



Code 39 On/Off



Code 39 Start/Stop Characters

Start/Stop characters identify the leading and trailing ends of the barcode. You may either transmit, or not transmit Start/Stop characters. *Default = Don't Transmit.*





Code 39 Check Character

No Check Character indicates that the scanner reads and transmits barcode data with or without a check character.

When Check Character is set to **Validate, but Don't Transmit**, the unit only reads Code 39 barcodes printed with a check character, but will not transmit the check character with the scanned data.

When Check Character is set to **Validate and Transmit**, the scanner only reads Code 39 barcodes printed with a check character, and will transmit this character at the end of the scanned data. *Default = No Check Character.*



Code 39 Message Length

Scan the barcodes below to change the message length. Refer to [Message Length Description](#) (page 64) for additional information. Minimum and Maximum lengths = 0-48. Minimum Default = 0, Maximum Default = 48.



Code 39 Append

This function allows the scanner to append the data from several Code 39 barcodes together before transmitting them to the host computer. When the scanner encounters a Code 39 barcode with the append trigger character(s), it buffers Code 39 barcodes until it reads a Code 39 barcode that does not have the append trigger. The data is then transmitted in the order in which the barcodes were read (FIFO). *Default = Off.*



C39APP1.

On



C39APP0.

*** Off**

Code 32 Pharmaceutical (PARAF)

Code 32 Pharmaceutical is a form of the Code 39 symbology used by Italian pharmacies. This symbology is also known as PARAF.



C39B321.

On



C39B320.

*** Off**

Full ASCII

If Full ASCII Code 39 decoding is enabled, certain character pairs within the barcode symbol will be interpreted as a single character. For example: \$V will be decoded as the ASCII character SYN, and /C will be decoded as the ASCII character #. *Default = Off.*

NUL %U	DLE \$P	SP SPACE	0 0	@ %V	P P	' %W	p +P
SOH \$A	DC1 \$Q	! /A	1 1	A A	Q Q	a +A	q +Q
STX \$B	DC2 \$R	" /B	2 2	B B	R R	b +B	r +R
ETX \$C	DC3 \$S	# /C	3 3	C C	S S	c +C	s +S
EOT \$D	DC4 \$T	\$ /D	4 4	D D	T T	d +D	t +T
ENQ \$E	NAK \$U	% /E	5 5	E E	U U	e +E	u +U
ACK \$F	SYN \$V	& /F	6 6	F F	V V	f +F	v +V
BEL \$G	ETB \$W	' /G	7 7	G G	W W	g +G	w +W
BS \$H	CAN \$X	(/H	8 8	H H	X X	h +H	x +X
HT \$I	EM \$Y) /I	9 9	I I	Y Y	i +I	y +Y
LF \$J	SUB \$Z	* /J	: /Z	J J	Z Z	j +J	z +Z
VT \$K	ESC %A	+ /K	; %F	K K	[%K	k +K	{ %P
FF \$L	FS %B	, /L	< %G	L L	\ %L	l +L	%Q
CR \$M	GS %C	- -	= %H	M M] %M	m +M	} %R
SO \$N	RS %D	. .	> %I	N N	^ %N	n +N	~ %S
SI \$O	US %E	/ /O	? %J	O O	_ %O	o +O	DEL %T

Character pairs /M and /N decode as a minus sign and period respectively. Character pairs /P through /Y decode as 0 through 9.



C39ASCII.
Full ASCII On



C39ASCII.
* Full ASCII Off

Code 39 Code Page

Code pages define the mapping of character codes to characters. If the data received does not display with the proper characters, it may be because the barcode being scanned was created using a code page that is different from the one the host program is expecting. If this is the case, scan the barcode below,

select the code page with which the barcodes were created (see [ISO 2022/ISO 646 Character Replacements](#) on page 158), and scan the value and the Save barcode from the [Programming Chart](#). The data characters should then appear properly.



Interleaved 2 of 5

< Default All Interleaved 2 of 5 Settings >



Interleaved 2 of 5 On/Off



Check Digit

No Check Digit indicates that the scanner reads and transmits barcode data with or without a check digit.

When Check Digit is set to **Validate, but Don't Transmit**, the unit only reads Interleaved 2 of 5 barcodes printed with a check digit, but will not transmit the check digit with the scanned data.

When Check Digit is set to **Validate and Transmit**, the scanner only reads Interleaved 2 of 5 barcodes printed with a check digit, and will transmit this digit at the end of the scanned data. *Default = No Check Digit.*





I25CK21.

Validate, but Don't Transmit



I25CK22.

Validate and Transmit

Interleaved 2 of 5 Message Length

Scan the barcodes below to change the message length. Refer to [Message Length Description](#) (page 64) for additional information. Minimum and Maximum lengths = 2-80. Minimum Default = 4, Maximum Default = 80.



I25MIN.

Minimum Message Length



I25MAX.

Maximum Message Length

NEC 2 of 5

< Default All NEC 2 of 5 Settings >



N25DFT.

NEC 2 of 5 On/Off



N25ENA1.

*** On**



N25ENA0.

Off

Check Digit

No Check Digit indicates that the scanner reads and transmits barcode data with or without a check digit.

When Check Digit is set to **Validate, but Don't Transmit**, the unit only reads NEC 2 of 5 barcodes printed with a check digit, but will not transmit the check digit with the scanned data.

When Check Digit is set to **Validate and Transmit**, the scanner only reads NEC 2 of 5 barcodes printed with a check digit, and will transmit this digit at the end of the scanned data. *Default = No Check Digit.*



N25CK20.

*** No Check Digit**



N25CK21.

Validate, but Don't Transmit



N25CK22.

Validate and Transmit

NEC 2 of 5 Message Length

Scan the barcodes below to change the message length. Refer to [Message Length Description](#) (page 64) for additional information. Minimum and Maximum lengths = 2-80. Minimum Default = 4, Maximum Default = 80.



N25MIN.

Minimum Message Length



N25MAX.

Maximum Message Length

Code 93

< Default All Code 93 Settings >



Code 93 On/Off



Code 93 Message Length

Scan the barcodes below to change the message length. Refer to [Message Length Description](#) (page 64) for additional information. Minimum and Maximum lengths = 0-80. Minimum Default = 0, Maximum Default = 80.



Code 93 Append

This function allows the scanner to append the data from several Code 93 barcodes together before transmitting them to the host computer. When this function is enabled, the scanner stores those Code 93 barcodes that start with a space (excluding the start and stop symbols), and does not immediately transmit the data. The scanner stores the data in the order in which the barcodes are read,

deleting the first space from each. The scanner transmits the appended data when it reads a Code 93 barcode that starts with a character other than a space. *Default = Off.*



Code 93 Code Page

Code pages define the mapping of character codes to characters. If the data received does not display with the proper characters, it may be because the barcode being scanned was created using a code page that is different from the one the host program is expecting. If this is the case, scan the barcode below, select the code page with which the barcodes were created (see [ISO 2022/ISO 646 Character Replacements](#) on page 158), and scan the value and the **Save** barcode from the [Programming Chart](#). The data characters should then appear properly.



Straight 2 of 5 Industrial (three-bar start/stop)

<Default All Straight 2 of 5 Industrial Settings>



Straight 2 of 5 Industrial On/Off



Straight 2 of 5 Industrial Message Length

Scan the barcodes below to change the message length. Refer to [Message Length Description](#) (page 64) for additional information. Minimum and Maximum lengths = 1-48. Minimum Default = 4, Maximum Default = 48.



R25MIN.

Minimum Message Length



R25MAX.

Maximum Message Length

Straight 2 of 5 IATA (two-bar start/stop)

<Default All Straight 2 of 5 IATA Settings>



A25DFT.

Straight 2 of 5 IATA On/Off



A25ENA1.

On



A25ENA0.

*** Off**

Straight 2 of 5 IATA Message Length

Scan the barcodes below to change the message length. Refer to [Message Length Description](#) (page 64) for additional information. Minimum and Maximum lengths = 1-48. Minimum Default = 4, Maximum Default = 48.



A25MIN.

Minimum Message Length



Matrix 2 of 5

<Default All Matrix 2 of 5 Settings>



Matrix 2 of 5 On/Off



Matrix 2 of 5 Message Length

Scan the barcodes below to change the message length. Refer to [Message Length Description](#) (page 64) for additional information. Minimum and Maximum lengths = 1-80. Minimum Default = 4, Maximum Default = 80.



Code 11

<Default All Code 11 Settings>



Code 11 On/Off



Check Digits Required

This option sets whether 1 or 2 check digits are required with Code 11 barcodes.
Default = Two Check Digits.



Code 11 Message Length

Scan the barcodes below to change the message length. Refer to [Message Length Description](#) (page 64) for additional information. Minimum and Maximum lengths = 1-80. Minimum Default = 4, Maximum Default = 80.



Code 128

<Default All Code 128 Settings>



Code 128 On/Off



ISBT 128 Concatenation

In 1994 the International Society of Blood Transfusion (ISBT) ratified a standard for communicating critical blood information in a uniform manner. The use of ISBT formats requires a paid license. The ISBT 128 Application Specification describes 1) the critical data elements for labeling blood products, 2) the current recommendation to use Code 128 due to its high degree of security and its space-efficient design, 3) a variation of Code 128 that supports concatenation of neighboring symbols, and 4) the standard layout for barcodes on a blood product label. Use the barcodes below to turn concatenation on or off. *Default =Off.*



Code 128 Message Length

Scan the barcodes below to change the message length. Refer to [Message Length Description](#) (page 64) for additional information. Minimum and Maximum lengths = 0-80. Minimum Default = 0, Maximum Default = 80.



128MIN.

Minimum Message Length



128MAX.

Maximum Message Length

Code 128 Append

This function allows the scanner to append the data from several Code 128 barcodes together before transmitting them to the host computer. When the scanner encounters a Code 128 barcode with the append trigger character(s), it buffers Code 128 barcodes until it reads a Code 128 barcode that does not have the append trigger. The data is then transmitted in the order in which the barcodes were read (FIFO). *Default = On.*



128APP1.

*** On**



128APP0.

Off

Code 128 Code Page

Code pages define the mapping of character codes to characters. If the data received does not display with the proper characters, it may be because the barcode being scanned was created using a code page that is different from the one the host program is expecting. If this is the case, scan the barcode below, select the code page with which the barcodes were created (see [ISO 2022/ISO 646 Character Replacements](#) on page 158), and scan the value and the Save barcode from the [Programming Chart](#). The data characters should then appear properly.



128DCP.

Code 128 Code Page

GS1-128

<Default All GS1-128 Settings>



GS1-128 On/Off



GS1-128 Message Length

Scan the barcodes below to change the message length. Refer to [Message Length Description](#) (page 64) for additional information. Minimum and Maximum lengths = 1-80. Minimum Default = 1, Maximum Default = 80.



UPC-A

<Default All UPC-A Settings>



UPC-A On/Off



Note: To convert UPC-A barcodes to EAN-13, see [Convert UPC-A to EAN-13](#) on page 88.

UPC-A Check Digit

This selection allows you to specify whether the check digit should be transmitted at the end of the scanned data or not. *Default = On.*



UPC-A Number System

The numeric system digit of a U.P.C. symbol is normally transmitted at the beginning of the scanned data, but the unit can be programmed so it will not transmit it. *Default = On.*





UPANSXD.
Off

UPC-A Addenda

This selection adds 2 or 5 digits to the end of all scanned UPC-A data.
Default = Off for both 2 Digit and 5 Digit Addenda.



UPAAD21.
2 Digit Addenda On



UPAAD20.
* 2 Digit Addenda Off



UPAAD51.
5 Digit Addenda On



UPAAD50.
* 5 Digit Addenda Off

UPC-A Addenda Required

When **Required** is scanned, the scanner will only read UPC-A barcodes that have addenda. You must then turn on a 2 or 5 digit addenda listed on [page 83](#). *Default = Not Required.*



UPAARQ1.
Required



UPAARQ0.
* Not Required

UPC-A Addenda Separator

When this feature is on, there is a space between the data from the barcode and the data from the addenda. When turned off, there is no space. *Default = On.*



UPAADS1.

* On



UPAADS0.

Off

UPC-A/EAN-13 with Extended Coupon Code

Use the following codes to enable or disable UPC-A and EAN-13 with Extended Coupon Code. When left on the default setting (**Off**), the scanner treats Coupon Codes and Extended Coupon Codes as single barcodes.

If you scan the **Allow Concatenation** code, when the scanner sees the coupon code and the extended coupon code in a single scan, it transmits both as one symbology. Otherwise, it transmits the first coupon code it reads.

If you scan the **Require Concatenation** code, the scanner must see and read the coupon code and extended coupon code in a single read to transmit the data. No data is output unless both codes are read. *Default = Off.*



CPNENA0.

* Off



CPNENA1.

Allow Concatenation



CPNENA2.

Require Concatenation

Coupon GS1 DataBar Output

If you scan coupons that have both UPC and GS1 Databarcodes, you may wish to scan and output only the data from the GS1 Databarcode. Scan the **GS1 Output On** code below to scan and output only the GS1 Databarcode data. *Default = GS1 Output Off.*



UPC-E0

<Default All UPC-E Settings>



UPC-E0 On/Off

Most U.P.C. barcodes lead with the 0 number system. To read these codes, use the **UPC-E0 On** selection. If you need to read codes that lead with the 1 number system, use [UPC-E1](#) (page 87). *Default = On.*



UPC-E0 Expand

UPC-E Expand expands the UPC-E code to the 12 digit, UPC-A format. *Default = Off.*





UPC-E0 Addenda Required

When **Required** is scanned, the scanner will only read UPC-E barcodes that have addenda. *Default = Not Required.*



UPC-E0 Addenda Separator

When this feature is **On**, there is a space between the data from the barcode and the data from the addenda. When turned **Off**, there is no space. *Default = On.*



UPC-E0 Check Digit

Check Digit specifies whether the check digit should be transmitted at the end of the scanned data or not. *Default = On.*



UPC-E0 Leading Zero

This feature allows the transmission of a leading zero (0) at the beginning of scanned data. To prevent transmission, scan **Off**. *Default = On.*



UPENSX1.

* On



UPENSX0.

Off

UPC-E0 Addenda

This selection adds 2 or 5 digits to the end of all scanned UPC-E data. *Default = Off for both 2 Digit and 5 Digit Addenda.*



UPEAD21.

2 Digit Addenda On



UPEAD20.

* 2 Digit Addenda Off



UPEAD51.

5 Digit Addenda On



UPEAD50.

* 5 Digit Addenda Off

UPC-E1

Most U.P.C. barcodes lead with the 0 number system. For these codes, use [UPC-E0](#) (page 85). If you need to read codes that lead with the 1 number system, use the **UPC-E1 On** selection. *Default = Off.*



UPEEN11.

UPC-E1 On



EAN/JAN-13

<Default All EAN/JAN Settings>



EAN/JAN-13 On/Off



Convert UPC-A to EAN-13

When **UPC-A Converted to EAN-13** is selected, UPC-A barcodes are converted to 13 digit EAN-13 codes by adding a zero to the front. When **Do not Convert UPC-A** is selected, UPC-A codes are read as UPC-A.



EAN/JAN-13 Check Digit

This selection allows you to specify whether the check digit should be transmitted at the end of the scanned data or not. *Default = On.*



E13CKX1.

*** On**



E13CKX0.

Off

EAN/JAN-13 Addenda

This selection adds 2 or 5 digits to the end of all scanned EAN/JAN-13 data. *Default = Off for both 2 Digit and 5 Digit Addenda.*



E13AD21.

2 Digit Addenda On



E13AD20.

*** 2 Digit Addenda Off**



E13AD51.

5 Digit Addenda On



E13AD50.

*** 5 Digit Addenda Off**

EAN/JAN-13 Addenda Required

When **Required** is scanned, the scanner will only read EAN/JAN-13 barcodes that have addenda. *Default = Not Required.*



E13ARQ1.

Required



EAN/JAN-13 Addenda Separator

When this feature is **On**, there is a space between the data from the barcode and the data from the addenda. When turned **Off**, there is no space. *Default = On.*



Note: If you want to enable or disable EAN13 with Extended Coupon Code, refer to [UPC-A/ EAN-13 with Extended Coupon Code](#) (page 84).

ISBN Translate

When **On** is scanned, EAN-13 Bookland symbols are translated into their equivalent ISBN number format. *Default = Off.*



EAN/JAN-8

<Default All EAN/JAN-8 Settings>



EAN/JAN-8 On/Off



EAN/JAN-8 Check Digit

This selection allows you to specify whether the check digit should be transmitted at the end of the scanned data or not. *Default = On.*



EAN/JAN-8 Addenda

This selection adds 2 or 5 digits to the end of all scanned EAN/JAN-8 data. *Default = Off for both 2 Digit Addenda and 5 Digit Addenda.*





EABAD51.
5 Digit Addenda On



EABAD50.
* 5 Digit Addenda Off

EAN/JAN-8 Addenda Required

When **Required** is scanned, the scanner will only read EAN/JAN-8 barcodes that have addenda. *Default = Not Required.*



EABARQ1.
Required



EABARQ0.
* Not Required

EAN/JAN-8 Addenda Separator

When this feature is **On**, there is a space between the data from the barcode and the data from the addenda. When turned **Off**, there is no space. *Default = On.*



EABADS1.
* On



EABADS0.
Off

MSI

<Default All MSI Settings>



MSI On/Off



MSI Check Character

Different types of check characters are used with MSI barcodes. You can program the scanner to read MSI barcodes with Type 10 check characters. *Default = Validate Type 10, but Don't Transmit.*

When Check Character is set to **Validate Type 10/11 and Transmit**, the scanner will only read MSI barcodes printed with the specified type check character(s), and will transmit the character(s) at the end of the scanned data.

When Check Character is set to **Validate Type 10/11, but Don't Transmit**, the unit will only read MSI barcodes printed with the specified type check character(s), but will not transmit the check character(s) with the scanned data.





MSCHK3.
Validate 2 Type 10 Characters and Transmit



MSCHK4.
Validate Type 11 then Type 10 Character, but Don't Transmit



MSCHK5.
Validate Type 11 then Type 10 Character and Transmit



MSCHK6.
Disable MSI Check Characters

MSI Message Length

Scan the barcodes below to change the message length. Refer to [Message Length Description](#) (page 64) for additional information. Minimum and Maximum lengths = 4-48. Minimum Default = 4, Maximum Default = 48.



MSIMIN.
Minimum Message Length



MSIMAX.
Maximum Message Length

GS1 DataBar Omnidirectional

< Default All GS1 DataBar Omnidirectional Settings >



RSSDFT.

GS1 DataBar Omnidirectional On/Off



RSSENA1.
* On



GS1 DataBar Limited

< Default All GS1 DataBar Limited Settings >



GS1 DataBar Limited On/Off



GS1 DataBar Expanded

< Default All GS1 DataBar Expanded Settings >



GS1 DataBar Expanded On/Off



GS1 DataBar Expanded Message Length

Scan the barcodes below to change the message length. Refer to [Message Length Description](#) (page 64) for additional information. Minimum and Maximum lengths = 4-74. Minimum Default = 4, Maximum Default = 74.



Codablock A

<Default All Codablock A Settings>



Codablock A On/Off



Codablock A Message Length

Scan the barcodes below to change the message length. Refer to [Message Length Description](#) (page 64) for additional information. Minimum and Maximum lengths = 1-600. Minimum Default = 1, Maximum Default = 600.





Codablock F

<Default All Codablock F Settings>



Codablock F On/Off



Codablock F Message Length

Scan the barcodes below to change the message length. Refer to [Message Length Description](#) (page 64) for additional information. Minimum and Maximum lengths = 1-2048. Minimum Default = 1, Maximum Default = 2048.



PDF417

< Default All PDF417 Settings >



PDF417 On/Off



PDF417 Message Length

Scan the barcodes below to change the message length. Refer to [Message Length Description](#) (page 64) for additional information. Minimum and Maximum lengths = 1-2750. Minimum Default = 1, Maximum Default = 2750.



MacroPDF417

MacroPDF417 is an implementation of PDF417 capable of encoding very large amounts of data into multiple PDF417 barcodes. When this selection is enabled, these multiple barcodes are assembled into a single data string. *Default = On.*





MicroPDF417

< Default All MicroPDF417 Settings >



MicroPDF417 On/Off



MicroPDF417 Message Length

Scan the barcodes below to change the message length. Refer to [Message Length Description](#) (page 64) for additional information. Minimum and Maximum lengths = 1-366. Minimum Default = 1, Maximum Default = 366.



GS1 Composite Codes

Linear codes are combined with a unique 2D composite component to form a new class called GS1 Composite symbology. GS1 Composite symbologies allow for the co-existence of symbologies already in use. *Default = Off.*



UPC/EAN Version

Scan the **UPC/EAN Version On** barcode to decode GS1 Composite symbols that have a U.P.C. or an EAN linear component. (This does not affect GS1 Composite symbols with a GS1-128 or GS1 linear component.) *Default = UPC/EAN Version Off.*



Note: *If you scan coupons that have both UPC and GS1 Databarcodes, you may wish to scan and output only the data from the GS1 Databarcode. See [Coupon GS1 DataBar Output](#) (page 85) for further information.*

GS1 Composite Code Message Length

Scan the barcodes below to change the message length. Refer to [Message Length Description](#) (page 64) for additional information. Minimum and Maximum lengths = 1-2435. Minimum Default = 1, Maximum Default = 2435.



GS1 Emulation

The scanner can automatically format the output from any GS1 data carrier to emulate what would be encoded in an equivalent GS1-128 or GS1 DataBar symbol. GS1 data carriers include UPC-A and UPC-E, EAN-13 and EAN-8, ITF-14, GS1-128, and GS1-128 DataBar and GS1 Composites. (Any application that accepts GS1 data can be simplified since it only needs to recognize one data carrier type.)

If **GS1-128 Emulation** is scanned, all retail codes (U.P.C., UPC-E, EAN8, EAN13) are expanded out to 16 digits. If the AIM ID is enabled, the value will be the GS1-128 AIM ID,]C1 (see [Symbology Charts](#) on page 151).

If **GS1 DataBar Emulation** is scanned, all retail codes (U.P.C., UPC-E, EAN8, EAN13) are expanded out to 16 digits. If the AIM ID is enabled, the value will be the GS1-DataBar AIM ID,]em (see [Symbology Charts](#) on page 151).

If **GS1 Code Expansion Off** is scanned, retail code expansion is disabled, and UPC-E expansion is controlled by the [UPC-E0 Expand](#) (page 85) setting. If the AIM ID is enabled, the value will be the GS1-128 AIM ID,]C1 (see [Symbology Charts](#) on page 151).

If **EAN8 to EAN13 Conversion** is scanned, all EAN8 barcodes are converted to EAN13 format.

Default = GS1 Emulation Off.



EANEMU1.
GS1-128 Emulation



EANEMU2.
GS1 DataBar Emulation



EANEMU3.
GS1 Code Expansion Off



EANEMU4.
EAN8 to EAN13 Conversion



EANEMU0.
*** GS1 Emulation Off**

TCIF Linked Code 39 (TLC39)

This code is a composite code since it has a Code 39 linear component and a MicroPDF417 stacked code component. All barcode readers are capable of reading the Code 39 linear component. The MicroPDF417 component can only be decoded if TLC39 On is selected. The linear component may be decoded as Code 39 even if TLC39 is off. *Default = Off.*



QR Code

< *Default All QR Code Settings* >



QR Code On/Off

This selection applies to both QR Code and Micro QR Code.



QR Code Message Length

Scan the barcodes below to change the message length. Refer to [Message Length Description](#) (page 64) for additional information. Minimum and Maximum lengths = 1-7089. Minimum Default = 1, Maximum Default = 7089.



QR Code Append

This function allows the scanner to append the data from several QR Code barcodes together before transmitting them to the host computer. When the scanner encounters an QR Code barcode with the append trigger character(s), it buffers the number of QR Code barcodes determined by information encoded in those barcodes. Once the proper number of codes is reached, the data is output in the order specified in the barcodes. There are 3 ways to scan appended QR Code:

- **One scan**—Pull the trigger one time and all appended QR Codes in the same image are decoded
- **Swipe**—Pull and hold down the trigger and scan all appended QR Codes while keeping the trigger pressed. The scanner emits short beeps for each partial QR Code that is scanned and buffered. One long beep is emitted after the last QR Code is scanned and the data is complete. Not compatible with Presentation mode.
- **Point and shoot**—Pull the trigger one time for each image. The scanner emits a short beep for each partial QR Code that is scanned and buffered. One long beep is emitted after the last QR Code is scanned and the data is complete. Not compatible with Presentation mode.

Default = One Scan.





QR Code Page

QR Code pages define the mapping of character codes to characters. If the data received does not display with the proper characters, it may be because the barcode being scanned was created using a code page that is different from the one the host program is expecting. If this is the case, scan the barcode below, select the code page with which the barcodes were created (see [ISO 2022/ISO 646 Character Replacements](#) on page 158), and scan the value and the Save barcode from the [Programming Chart](#). The data characters should then appear properly.



Data Matrix

< Default All Data Matrix Settings >



Data Matrix On/Off



Data Matrix Message Length

Scan the barcodes below to change the message length. Refer to [Message Length Description](#) (page 64) for additional information. Minimum and Maximum lengths = 1-3116. Minimum Default = 1, Maximum Default = 3116.



Data Matrix Code Page

Data Matrix Code pages define the mapping of character codes to characters. If the data received does not display with the proper characters, it may be because the barcode being scanned was created using a code page that is different from the one the host program is expecting. If this is the case, scan the barcode below, select the code page with which the barcodes were created (see [ISO 2022/ISO 646 Character Replacements](#) on page 158), and scan the value and the Save barcode from the [Programming Chart](#). The data characters should then appear properly.



MaxiCode

< Default All MaxiCode Settings >



MaxiCode On/Off



MaxiCode Message Length

Scan the barcodes below to change the message length. Refer to [Message Length Description](#) (page 64) for additional information. Minimum and Maximum lengths = 1-150. Minimum Default = 1, Maximum Default = 150.



Aztec Code

< Default All Aztec Code Settings >



Aztec Code On/Off



Aztec Code Message Length

Scan the barcodes below to change the message length. Refer to [Message Length Description](#) (page 64) for additional information. Minimum and Maximum lengths = 1-3832. Minimum Default = 1, Maximum Default = 3832.



Aztec Append

This function allows the scanner to append the data from several Aztec barcodes together before transmitting them to the host computer. When the scanner encounters an Aztec barcode with the append trigger character(s), it buffers the number of Aztec barcodes determined by information encoded in those barcodes. Once the proper number of codes is reached, the data is output in the order specified in the barcodes. There are 3 ways to scan appended Aztec Code:

- **One scan**—Pull the trigger one time and all appended Aztec Codes in the same image are decoded
- **Swipe**—Pull and hold down the trigger and scan all appended Aztec Codes while keeping the trigger pressed. The scanner emits short beeps for each partial Aztec Code that is scanned and buffered. One long beep is emitted after the last Aztec Code is scanned and the data is complete. Not compatible with Presentation mode.
- **Point and shoot**—Pull the trigger one time for each image. The scanner emits a short beep for each partial Aztec Code that is scanned and buffered. One long beep is emitted after the last Aztec Code is scanned and the data is complete. Not compatible with Presentation mode.

Default = One Scan.

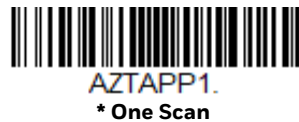

Aztec Code Page

Aztec Code pages define the mapping of character codes to characters. If the data received does not display with the proper characters, it may be because the barcode being scanned was created using a code page that is different from the one the host program is expecting. If this is the case, scan the barcode below, select the code page with which the barcodes were created (see [ISO 2022/ISO 646 Character Replacements](#) on page 158), and scan the value and the Save barcode from the [Programming Chart](#). The data characters should then appear properly.



Chinese Sensible (Han Xin) Code

< Default All Han Xin Settings >



Han Xin Code On/Off

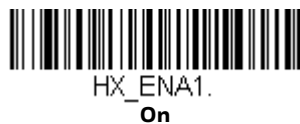

Han Xin Code Message Length

Scan the barcodes below to change the message length. Refer to [Message Length Description](#) (page 64) for additional information. Minimum and Maximum lengths = 1-7833. Minimum Default = 1, Maximum Default = 7833.



Postal Codes - 2D

The following lists the possible 2D postal codes, and 2D postal code combinations that are allowed. Only one 2D postal code selection can be active at a time. If you scan a second 2D postal code selection, the first selection is overwritten. *Default = 2D Postal Codes Off.*



Single 2D Postal Codes:





POSTAL6.
Postnet On
 Also see [Postnet](#)



POSTAL2.
InfoMail On



POSTAL11.
Postnet with B and B' Fields On

Combination 2D Postal Codes:



POSTAL8.
**InfoMail and British
 Post On**



POSTAL20.
**Intelligent Mail barcode and
 Postnet with B and B' Fields On**



POSTAL14.
**Postnet and
 Postal-4i On**



POSTAL16.
**Postnet and
 Intelligent Mail barcode On**



POSTAL17.
**Postal-4i and
 Intelligent Mail barcode On**



POSTAL19.
**Postal-4i and
 Postnet with B and B' Fields On**



POSTAL12.
Planet Code and
Postnet On



POSTAL13.
Planet Code and
Postal-4i On



POSTAL21.
Planet Code,
Postnet, and
Postal-4i On



POSTAL23.
Planet Code,
Postal-4i, and
Intelligent Mail barcode On



POSTAL25.
Planet Code,
Postal-4i, and
Postnet with B and B' Fields On



POSTAL18.
Planet Code and
Postnet with B and B' Fields On



POSTAL15.
Planet Code and
Intelligent Mail barcode



POSTAL22.
Planet Code,
Postnet, and
Intelligent Mail barcode On



POSTAL24.
Postnet,
Postal-4i, and
Intelligent Mail barcode On



POSTAL26.
Planet Code,
Intelligent Mail barcode, and
Postnet with B and B' Fields On



POSTAL27.
Postal-4i,
Intelligent Mail barcode, and
Postnet with B and B' Fields On



POSTAL28.
Planet Code,
Postal-4i,
Intelligent Mail barcode, and
Postnet On



POSTAL29.
Planet Code,
Postal-4i,
Intelligent Mail barcode, and
Postnet with B and B' Fields On

Planet Code Check Digit

This selection allows you to specify whether the check digit should be transmitted at the end of Planet Code data. *Default = Don't Transmit.*



PLNCKX1.
Transmit Check Digit



PLNCKX0.
* Don't Transmit Check Digit

Postnet Check Digit

This selection allows you to specify whether the check digit should be transmitted at the end of Postnet data. *Default = Don't Transmit.*



NETCKX1.
Transmit Check Digit



NETCKX0.
* Don't Transmit Check Digit

Australian Post Interpretation

This option controls what interpretation is applied to customer fields in Australian 4-State symbols.

Bar Output lists the bar patterns in “0123” format.

Numeric N Table causes that field to be interpreted as numeric data using the N Table.

Alphanumeric C Table causes the field to be interpreted as alphanumeric data using the C Table. Refer to the Australian Post Specification Tables.

Combination C and N Tables causes the field to be interpreted using either the C or N Tables.



AUSINT0.

* Bar Output



AUSINT1.

Numeric N Table



AUSINT2.

Alphanumeric C Table



AUSINT3.

Combination C and N Tables

Postal Codes - Linear

The following lists linear postal codes. Any combination of linear postal code selections can be active at a time.

China Post (Hong Kong 2 of 5)

<Default All China Post (Hong Kong 2 of 5) Settings>



CPCDFT.

China Post (Hong Kong 2 of 5) On/Off



China Post (Hong Kong 2 of 5) Message Length

Scan the barcodes below to change the message length. Refer to [Message Length Description](#) (page 64) for additional information. Minimum and Maximum lengths = 2-80. Minimum Default = 4, Maximum Default = 80.



Korea Post

<Default All Korea Post Settings>



Korea Post On/Off



Korea Post Message Length

Scan the barcodes below to change the message length. Refer to [Message Length Description](#) (page 64) for additional information. Minimum and Maximum lengths = 2-80. Minimum Default = 4, Maximum Default = 48.



KPCMIN.

Minimum Message Length



KPCMAX.

Maximum Message Length

Korea Post Check Digit

This selection allows you to specify whether the check digit should be transmitted.
Default = Don't Transmit.



KPCCHK1.

Transmit Check Digit



KPCCHK0.

*** Don't Transmit Check Digit**

Add a Test Code I.D. Prefix to All Symbologies

This selection allows you to turn on transmission of a Code I.D. before the decoded symbology. (See the [Symbology Charts](#), beginning on page 151) for the single character code that identifies each symbology.) This action first clears all current prefixes, then programs a Code I.D. prefix for all symbologies. This is a temporary setting that will be removed when the unit is power cycled.



PRECA2,BK2995C80!

**Add Code I.D. Prefix to
All Symbologies (Temporary)**

Show Software Revision

Scan the barcode below to output the current software revision, unit serial number, and other product information for the scanner.



REVINF.

Show Revision

Show Data Format

See ["Show Data Format" on page 50.](#)

Test Menu

When you scan the **Test Menu On** code, then scan a programming code in this manual, the scanner displays the content of a programming code. The programming function will still occur, but in addition, the content of that programming code is output to the terminal.

Note: *This feature should not be used during normal scanner operation.*



EZConfig for Scanning Introduction

EZConfig for Scanning provides a wide range of PC-based programming functions that can be performed on a scanner connected to your PC. EZConfig for Scanning allows you to download upgrades to the scanner's firmware, change programmed parameters, and create and print programming barcodes. Using EZConfig for Scanning, you can even save/open the programming parameters for a scanner. This saved file can be e-mailed or, if required, you can create a single barcode that contains all the customized programming parameters and mail or fax that barcode to any location. Users in other locations can scan the barcode to load in the customized programming.

EZConfig for Scanning Operations

The EZConfig for Scanning software performs the following operations:

Scan Data

Scan Data allows you to scan barcodes and display the barcode data in a window. Scan Data lets you send serial commands to the scanner and receive scanner response that can be seen in the Scan Data window. The data displayed in the Scan Data window can either be saved in a file or printed.

Configure

Configure displays the programming and configuration data of the scanner. The scanner's programming and configuration data is grouped into different categories. Each category is displayed as a tree item under the "Configure" tree node in

the application explorer. When one of these tree nodes is clicked, the right-hand side is loaded with the parameters' form belonging to that particular category. The “Configure” tree option has all the programming and configuration parameters specified for a scanner. You can set or modify these parameters as required. You can later write the modified settings to the scanner, or save them to a dcf file.

Install EZConfig Cloud for Scanning

Use the EZConfig Cloud for Scanning tool to configure your scanner online:

1. Access the Honeywell web site at www.honeywellaidc.com
2. Click on the **Browse Products** tab. Under **Software**, select **Device Management**.
3. Click on **EZConfig Cloud for Scanning**.
4. Scroll to the bottom of the page and click on **Register for free access now** to sign up.

Reset the Factory Defaults



Caution: *This selection erases all your settings and resets the scanner to the original factory defaults. It also disables all plugins.*

If you aren't sure what programming options are in your scanner, or you've changed some options and want to restore the scanner to factory default settings, first scan the **Remove Custom Defaults** barcode, then scan **Activate Defaults**. This resets the scanner to the factory default settings.



The [Menu Commands](#), beginning on page 125 list the factory default settings for each of the commands (indicated by an asterisk (*) on the programming pages).

SERIAL PROGRAMMING COMMANDS

The serial programming commands can be used in place of the programming bar codes. Both the serial commands and the programming bar codes will program the scanner. For complete descriptions and examples of each serial programming command, refer to the corresponding programming bar code in this manual.

The device must be set to an RS232 interface (see [page 5](#)). The following commands can be sent via a PC COM port using terminal emulation software.

Conventions

The following conventions are used for menu and query command descriptions:

<i>parameter</i>	A label representing the actual value you should send as part of a command.
[<i>option</i>]	An optional part of a command.
{Data}	Alternatives in a command.
bold	Names of menus, menu commands, buttons, dialog boxes, and windows that appear on the screen.

Menu Command Syntax

Menu commands have the following syntax (spaces have been used for clarity only):

Prefix [:Name:] *Tag* *SubTag* {Data} [, *SubTag* {Data}] [; *Tag* *SubTag* {Data}] [...] *Storage*

Prefix Three ASCII characters: SYN M CR (ASCII 22,77,13).

Tag A 3 character case-insensitive field that identifies the desired menu command group. For example, all RS232 configuration settings are identified with a Tag of **232**.

SubTag	A 3 character case-insensitive field that identifies the desired menu command within the tag group. For example, the SubTag for the RS232 baud rate is BAD .
Data	The new value for a menu setting, identified by the Tag and SubTag.
Storage	A single character that specifies the storage table to which the command is applied. An exclamation point (!) performs the command's operation on the device's volatile menu configuration table. A period (.) performs the command's operation on the device's non-volatile menu configuration table. Use the non-volatile table only for semi-permanent changes you want saved through a power cycle.

Query Commands

Several special characters can be used to query the device about its settings.

^	What is the default value for the setting(s).
?	What is the device's current value for the setting(s).
*	What is the range of possible values for the setting(s). (The device's response uses a dash (-) to indicate a continuous range of values. A pipe () separates items in a list of non-continuous values.)

:Name: Field Usage (Optional)

This command returns the query information from the scanner.

Tag Field Usage

When a query is used in place of a Tag field, the query applies to the *entire* set of commands available for the particular storage table indicated by the Storage field of the command. In this case, the SubTag and Data fields should not be used because they are ignored by the device.

SubTag Field Usage

When a query is used in place of a SubTag field, the query applies only to the subset of commands available that match the Tag field. In this case, the Data field should not be used because it is ignored by the device.

Data Field Usage

When a query is used in place of the Data field, the query applies only to the specific command identified by the Tag and SubTag fields.

Concatenation of Multiple Commands

Multiple commands can be issued within one Prefix/Storage sequence. Only the Tag, SubTag, and Data fields must be repeated for each command in the sequence. If additional commands are to be applied to the same Tag, then the new command sequence is separated with a comma (,) and only the SubTag and Data fields of the additional command are issued. If the additional command requires a different Tag field, the command is separated from previous commands by a semicolon (;).

Responses

The device responds to serial commands with one of three responses:

- ACK** Indicates a good command which has been processed.
- ENQ** Indicates an invalid Tag or SubTag command.
- NAK** Indicates the command was good, but the Data field entry was out of the allowable range for this Tag and SubTag combination, e.g., an entry for a minimum message length of 100 when the field will only accept 2 characters.

When responding, the device echoes back the command sequence with the status character inserted directly before each of the punctuation marks (the period, exclamation point, comma, or semicolon) in the command.

Examples of Query Commands

In the following examples, a bracketed notation [] depicts a non-displayable response.

Example: What is the range of possible values for Codabar Coding Enable?

Enter: **cbrena*.**

Response: **CBRENA0-1[ACK]**

This response indicates that Codabar Coding Enable (CBRENA) has a range of values from 0 to 1 (off and on).

Example: What is the default value for Codabar Coding Enable?

Enter: **cbrena^.**

Response: **CBRENA1[ACK]**

This response indicates that the default setting for Codabar Coding Enable (CBRENA) is 1, or on.

Example: What is the device's current setting for Codabar Coding Enable?

Enter: **cbrena?.**

Response: **CBRENA1[ACK]**

This response indicates that the device's Codabar Coding Enable (CBRENA) is set to 1, or on.

Example: What are the device's settings for all Codabar selections?

Enter: **cbr?.**

Response: **CBRENA1[ACK],
SSX0[ACK],
CK20[ACK],
CCT1[ACK],
MIN2[ACK],
MAX60[ACK],
DFT[ACK].**

This response indicates that the device's Codabar Coding Enable (CBRENA) is set to 1, or on;
the Start/Stop Character (SSX) is set to 0, or Don't Transmit;
the Check Character (CK2) is set to 0, or Not Required;
concatenation (CCT) is set to 1, or Enabled;
the Minimum Message Length (MIN) is set to 2 characters;
the Maximum Message Length (MAX) is set to 60 characters;
and the Default setting (DFT) has no value.

Trigger Commands

You can activate and deactivate the scanner with serial trigger commands. First, the scanner must be put in Serial Trigger Mode by scanning a serial menu command for triggering ([page 30](#)). Once the scanner is in serial trigger mode, the trigger is activated and deactivated by sending the following commands:

Activate: **SYN T CR**

Deactivate: **SYN U CR**

The scanner scans until a bar code has been read, until the deactivate command is sent, or until the serial time-out has been reached (see [Read Time-Out](#) on page 30 for a description, and the serial command on [page 130](#)).

Reset the Custom Defaults

If you want the custom default settings restored to your scanner, scan the **Activate Custom Defaults** bar code below. This resets the scanner to the custom default settings. If there are no custom defaults, it will reset the scanner to the factory default settings. Any settings that have not been specified through the custom defaults will be defaulted to the factory default settings.



DEFAULT.

Activate Custom Defaults

The charts on the following pages list the factory default settings for each of the commands (indicated by an asterisk (*) on the programming pages).

Menu Commands

Selection	Setting * Indicates default	Serial Command # Indicates a numeric entry	Page
Product Default Settings			
Set Custom Defaults	Set Custom Defaults	MNUCDP	4
	Save Custom Defaults	MNUCDS	4
Reset the Custom Defaults	Activate Custom Defaults	DEFAULT	4
Program the Interface			
Plug and Play Codes: RS232	RS232 Serial Port	PAP232	5
Plug and Play Codes: IBM SurePos	USB IBM SurePos Handheld	PAPSPH	6
	USB IBM SurePos Tabletop	PAPSPT	6
Plug and Play Codes: USB	USB Keyboard (PC)	PAP124	6
	USB Keyboard (Mac)	PAP125	6
	USB Japanese Keyboard (PC)	TERMID134	6
	USB HID	PAP131	7
	USB Serial	TERMID130	7
	CTS/RTS Emulation On	USBCTS1	7
	CTS/RTS Emulation Off*	USBCTS0	7
	ACK/NAK Mode On	USBACK1	7
ACK/NAK Mode Off*	USBACK0	7	
Remote MasterMind for USB	ReM Off	REMIFC0	8
	*ReM On	REMIFC1	8
Program Keyboard Country	*U.S.A.	KBDCTY0	8
	Albania	KBDCTY35	8

Selection	Setting * Indicates default	Serial Command # Indicates a numeric entry	Page
	Azeri (Cyrillic)	KBDCTY81	8
	Azeri (Latin)	KBDCTY80	8
	Belarus	KBDCTY82	8
	Belgium	KBDCTY1	9
	Bosnia	KBDCTY33	9
	Brazil	KBDCTY16	9
	Brazil (MS)	KBDCTY59	9
	Bulgaria (Cyrillic)	KBDCTY52	9
	Bulgaria (Latin)	KBDCTY53	9
	Canada (French legacy)	KBDCTY54	9
	Canada (French)	KBDCTY18	9
	Canada (Multilingual)	KBDCTY55	9
	Croatia	KBDCTY32	9
	Czech	KBDCTY15	9
	Czech (Programmers)	KBDCTY40	9
	Czech (QWERTY)	KBDCTY39	10
	Czech (QWERTZ)	KBDCTY38	10
	Denmark	KBDCTY8	10
	Dutch (Netherlands)	KBDCTY11	10
	Estonia	KBDCTY41	10
	Faroese	KBDCTY83	10
	Finland	KBDCTY2	10
	France	KBDCTY3	10
	Gaelic	KBDCTY84	10
	Germany	KBDCTY4	10
	Greek	KBDCTY17	10
	Greek (220 Latin)	KBDCTY64	10
	Greek (220)	KBDCTY61	11
	Greek (319 Latin)	KBDCTY65	11
	Greek (319)	KBDCTY62	11
	Greek (Latin)	KBDCTY63	11
	Greek (MS)	KBDCTY66	11
	Greek (Polytonic)	KBDCTY60	11
	Hebrew	KBDCTY12	11
	Hungarian (101 key)	KBDCTY50	11
	Hungary	KBDCTY19	11
	Iceland	KBDCTY75	11

Selection	Setting * Indicates default	Serial Command # Indicates a numeric entry	Page
	Irish	KBDCTY73	11
	Italian (142)	KBDCTY56	11
	Italy	KBDCTY5	12
	Japan ASCII	KBDCTY28	12
	Kazakh	KBDCTY78	12
	Kyrgyz (Cyrillic)	KBDCTY79	12
	Latin America	KBDCTY14	12
	Latvia	KBDCTY42	12
	Latvia (QWERTY)	KBDCTY43	12
	Lithuania	KBDCTY44	12
	Lithuania (IBM)	KBDCTY45	12
	Macedonia	KBDCTY34	12
	Malta	KBDCTY74	12
	Mongolian (Cyrillic)	KBDCTY86	12
	Norway	KBDCTY9	13
	Poland	KBDCTY20	13
	Polish (214)	KBDCTY57	13
	Polish (Programmers)	KBDCTY58	13
	Portugal	KBDCTY13	13
	Romania	KBDCTY25	13
	Russia	KBDCTY26	13
	Russian (MS)	KBDCTY67	13
	Russian (Typewriter)	KBDCTY68	13
	SCS	KBDCTY21	13
	Serbia (Cyrillic)	KBDCTY37	13
	Serbia (Latin)	KBDCTY36	13
	Slovakia	KBDCTY22	14
	Slovakia (QWERTY)	KBDCTY49	14
	Slovakia (QWERTZ)	KBDCTY48	14
	Slovenia	KBDCTY31	14
	Spain	KBDCTY10	14
	Spanish variation	KBDCTY51	14
	Sweden	KBDCTY23	14
	Switzerland (French)	KBDCTY29	14
	Switzerland (German)	KBDCTY6	14
	Tatar	KBDCTY85	14
	Turkey F	KBDCTY27	14

Selection	Setting * Indicates default	Serial Command # Indicates a numeric entry	Page
	Turkey Q	KBDCTY24	14
	Ukrainian	KBDCTY76	15
	United Kingdom	KBDCTY7	15
	United States (Dvorak right)	KBDCTY89	15
	United States (Dvorak left)	KBDCTY88	15
	United States (Dvorak)	KBDCTY87	15
	United States (International)	KBDCTY30	15
	Uzbek (Cyrillic)	KBDCTY77	15
Keyboard Style	*Regular	KBDSTY0	15
	Caps Lock	KBDSTY1	15
	Shift Lock	KBDSTY2	16
	Automatic Caps Lock	KBDSTY6	16
	Autocaps via NumLock	KBDSTY7	16
	Emulate External Keyboard	KBDSTY5	16
Keyboard Conversion	*Keyboard Conversion Off	KBDCNV0	17
	Convert all Characters to Upper Case	KBDCNV1	17
	Convert all Characters to Lower Case	KBDCNV2	17
Control Character Output	*Control Character Output Off	KBDNPE0	17
	*Control Character Output On	KBDNPE1	17
Keyboard Modifiers	*Control + ASCII Off	KBDCAS0	18
	DOS Mode Control + ASCII	KBDCAS1	18
	Windows Mode Control + ASCII	KBDCAS2	18
	Windows Mode Prefix/Suffix Off	KBDCAS3	18
	*Turbo Mode Off	KBDTMD0	18
	Turbo Mode On	KBDTMD1	18
	*Numeric Keypad Off	KBDNPS0	18
	Numeric Keypad On	KBDNPS1	18
	*Auto Direct Connect Off	KBDADC0	19
	Auto Direct Connect On	KBDADC1	19
Baud Rate	300 BPS	232BAD0	19
	600 BPS	232BAD1	19
	1200 BPS	232BAD2	19
	2400 BPS	232BAD3	19
	4800 BPS	232BAD4	19
	9600 BPS	232BAD5	20
	19200 BPS	232BAD6	20
	38400 BPS	232BAD7	20

Selection	Setting * Indicates default	Serial Command # Indicates a numeric entry	Page
	57600 BPS	232BAD8	20
	*115200 BPS	232BAD9	20
Word Length: Data Bits, Stop Bits, and Parity	7 Data, 1 Stop, Parity Even	232WRD3	20
	7 Data, 1 Stop, Parity None	232WRD0	20
	7 Data, 1 Stop, Parity Odd	232WRD6	20
	7 Data, 2 Stop, Parity Even	232WRD4	20
	7 Data, 2 Stop, Parity None	232WRD1	20
	7 Data, 2 Stop, Parity Odd	232WRD7	21
	8 Data, 1 Stop, Parity Even	232WRD5	21
	*8 Data, 1 Stop, Parity None	232WRD2	21
	8 Data, 1 Stop, Parity Odd	232WRD8	21
RS232 Receiver Time-out	Range 0 - 300 seconds	232LPT###	21
RS232 Handshaking	*RTS/CTS Off	232CTS0	22
	Flow Control, No Timeout	232CTS1	22
	Two-Direction Flow Control	232CTS2	22
	Flow Control with Timeout	232CTS3	22
	RS232 Timeout	232DEL####	22
	*XON/XOFF Off	232XON0	22
	XON/XOFF On	232XON1	22
	*ACK/NAK Off	232ACK0	23
	ACK/NAK On	232ACK1	23
Scanner-Bioptic Packet Mode	*Packet Mode Off	232PKT0	23
	Packet Mode On	232PKT2	23
Scanner-Bioptic ACK/NAK Mode	*Bioptic ACK/NAK Off	232NAK0	24
	Bioptic ACK/NAK On	232NAK1	24
Scanner-Bioptic ACK/NAK Timeout	ACK/NAK Timeout *5100	232DLK#####	24
Input/Output Selections			
Power Up Beeper	Power Up Beeper Off - Scanner	BEPPWR0	25
	*Power Up Beeper On - Scanner	BEPPWR1	25
Beep on BEL Character	Beep on BEL On	BELBEP1	25
	*Beep on BEL Off	BELBEPO	25
Beeper - Good Read	Off	BEPBEPO	26
	*On	BEPBEP1	26

Selection	Setting * Indicates default	Serial Command # Indicates a numeric entry	Page
Beeper Volume - Good Read	Off	BEPLVL0	26
	Low	BEPLVL1	26
	Medium	BEPLVL2	26
	*High	BEPLVL3	26
Beeper Pitch - Good Read (Frequency)	Low (1600) (min 400Hz)	BEPFQ11600	26
	*Medium (2400)	BEPFQ12400	27
	High (4200) (max 9000Hz)	BEPFQ14200	27
Beeper Pitch - Error (Frequency)	*Razz (250) (min 200Hz)	BEPFQ2250	27
	Medium (3250)	BEPFQ23250	27
	High (4200) (max 9000Hz)	BEPFQ24200	27
Beeper Duration - Good Read	*Normal Beep	BEPBIP0	27
	Short Beep	BEPBIP1	27
LED - Good Read	Off	BEPLED0	28
	*On	BEPLED1	28
Number of Beeps - Good Read	Range 1 - 9	BEPRPT#	28
Number of Beeps - Error	Range 1 - 9	BEPERR#	28
Good Read Delay	*No Delay	DLYGRD0	29
	Short Delay (500 ms)	DLYGRD500	29
	Medium Delay (1000 ms)	DLYGRD1000	29
	Long Delay (1500 ms)	DLYGRD1500	29
User-Specified Good Read Delay	Range 0 - 30,000 ms	DLYGRD#####	29
IR Trigger	*IR Trigger Mode	TRGMOD0	29
LED Illumination	Low	PWRNOL0	30
	Medium	PWRNOL1	30
	*High	PWRNOL2	30
Serial Trigger Mode	Read Time-Out (range 0-300,000) *30,000	TRGSTO#####	30
Presentation	Presentation Mode	TRGMOD3	31
Presentation Centering Window	Presentation Centering On	PDCWIN1	32
	*Presentation Centering Off	PDCWIN0	32
	Top of Presentation Centering Window (*40%)	PDCTOP###	32
	Bottom of Presentation Centering Window (*60%)	PDCBOT###	33
	Left of Presentation Centering Window (*40%)	PDCLFT###	33
	Right of Presentation Centering Window (*60%)	PDCRGT###	33

Selection	Setting * Indicates default	Serial Command # Indicates a numeric entry	Page
Streaming Presentation Mode	*Normal	TRGMOD8;PDCEMX500; PDCGMX8	33
	Enhanced	TRGMOD8;PDCEMX150; PDCGMX12	33
Read Mode	*Paper and Screen	ILLMOD1	34
	Paper Only	ILLMOD0	34
	Screen Only	ILLMOD2	34
Poor Quality Codes	Poor Quality 1D Reading On	DECLD11	34
	*Poor Quality 1D Reading Off	DECLD10	34
	Poor Quality PDF Reading On	PDFXPR10	35
	*Poor Quality PDF Reading Off	PDFXPR0	35
Reread Delay	Short (500 ms)	DLYRRD500	35
	*Medium (750 ms)	DLYRRD750	35
	Long (1000 ms)	DLYRRD1000	35
	Extra Long (2000 ms)	DLYRRD2000	35
User-Specified Reread Delay	Range 0 - 30,000 ms	DLYRRD#####	36
2D Reread Delay	*2D Reread Delay Off	DLY2RR0	36
	Short (1000ms)	DLY2RR1000	36
	Medium (2000ms)	DLY2RR2000	36
	Long (3000ms)	DLY2RR3000	36
	Extra Long (4000ms)	DLY2RR4000	36
Character Activation Mode	*Off	HSTCEN0	36
	On	HSTCEN1	36
	Activation Character	HSTACH##	37
	Do Not End Character Activation After Good Read	HSTCGD0	37
	*End Character Activation After Good Read	HSTCGD1	37
	Character Activation Timeout (Range 1 - 65525) *5000 ms	HSTCDT#####	38
Character Deactivation Mode	*Off	HSTDEN0	38
	On	HSTDEN1	38
	Deactivation Character	HSTDCH##	38
User-Specified Reread Delay	Range 0 - 30,000 ms	DLYRRD#####	36
Illumination Lights	*Lights On	SCNLED1	39
	Lights Off	SCNLED0	39
No Read	On	SHWNRD1	39
	*Off	SHWNRD0	39

Selection	Setting * Indicates default	Serial Command # Indicates a numeric entry	Page
Video Reverse	Video Reverse Only	VIDREV1	39
	Video Reverse and Standard Bar Codes	VIDREV2	40
	*Video Reverse Off	VIDREV0	40
Working Orientation	*Upright	ROTATN0	40
	Vertical, Bottom to Top (Rotate CCW 90°)	ROTATN1	40
	Upside Down	ROTATN2	40
	Vertical, Top to Bottom (Rotate CW 90°)	ROTATN3	41
Prefix/Suffix Selections			
Add CR Suffix to All Symbologies		VSUFCR	45
Prefix	Add Prefix	PREBK2##	45
	Clear One Prefix	PRECL2	45
	Clear All Prefixes	PRECA2	45
Suffix	Add Suffix	SUFBK2##	45
	Clear One Suffix	SUFCL2	45
	Clear All Suffixes	SUFCA2	45
Function Code Transmit	*Enable	RMVFNC0	46
	Disable	RMVFNC1	46
Intercharacter Delay	Range 0 - 1000 (5ms increments)	DLYCHR##	46
User Specified Intercharacter Delay	Delay Length 0 - 1000 (5ms increments)	DLYCRX##	47
	Character to Trigger Delay	DLY_XX##	47
Interfunction Delay	Range 0 - 1000 (5ms increments)	DLYFNC##	47
Intermessage Delay	Range 0 - 1000 (5ms increments)	DLYMSG##	48
Data Formatter Selections			
Data Format Editor	*Default Data Format (None)	DFMDF3	49
	Show Data Format	DFMBK3?	50
	Enter Data Format	DFMBK3##	50
	Save Data Format	MNUSAV	51
	Discard Data Format	MNUABT	51
	Clear One Data Format	DFMCL3	51
	Clear All Data Formats	DFMCA3	51
Data Formatter	Data Formatter Off	DFM_EN0	61
	*Data Formatter On, Not Required, Keep Prefix/Suffix	DFM_EN1	61
	Data Format Required, Keep Prefix/Suffix	DFM_EN2	61

Selection	Setting * Indicates default	Serial Command # Indicates a numeric entry	Page
Primary/Alternate Data Formats	Primary Data Format	ALTFNM0	61
	Data Format 1	ALTFNM1	62
	Data Format 2	ALTFNM2	62
	Data Format 3	ALTFNM3	62
Symbologies			
All Symbologies	All Symbologies Off	ALLENA0	64
	All Symbologies On	ALLENA1	64
Codabar	Default All Codabar Settings	CBRDFT	65
	Off	CBRENA0	65
	*On	CBRENA1	65
Codabar Start/Stop Char.	*Don't Transmit	CBRSSX0	65
	Transmit	CBRSSX1	65
Codabar Check Char.	*No Check Char.	CBRCK20	66
	Validate, But Don't Transmit	CBRCK21	66
	Validate, and Transmit	CBRCK22	66
Codabar Concatenation	*Off	CBRCCT0	66
	On	CBRCCT1	66
	Require	CBRCCT2	66
Codabar Message Length	Minimum (2 - 60) *4	CBRMIN##	67
	Maximum (2 - 60) *60	CBRMAX##	67
Code 39	Default All Code 39 Settings	C39DFT	67
	Off	C39ENA0	67
	*On	C39ENA1	67
Code 39 Start/Stop Char.	*Don't Transmit	C39SSX0	68
	Transmit	C39SSX1	67
Code 39 Check Char.	*No Check Char.	C39CK20	68
	Validate, But Don't Transmit	C39CK21	68
	Validate and Transmit	C39CK22	68
Code 39 Message Length	Minimum (0 - 48) *0	C39MIN##	68
	Maximum (0 - 48) *48	C39MAX##	68
Code 39 Append	*Off	C39APP0	69
	On	C39APP1	69
Code 32 Pharmaceutical (PARAF)	*Off	C39B320	69
	On	C39B321	69
Code 39 Full ASCII	*Off	C39ASC0	70
	On	C39ASC1	70
	Code 39 Code Page	C39DCP	71

Selection	Setting * Indicates default	Serial Command # Indicates a numeric entry	Page
Interleaved 2 of 5	Default All Interleaved 2 of 5 Settings	I25DFT	71
	Off	I25ENAO	71
	*On	I25ENA1	71
Interleaved 2 of 5 Check Digit	*No Check Char.	I25CK20	71
	Validate, But Don't Transmit	I25CK21	72
	Validate and Transmit	I25CK22	72
Interleaved 2 of 5 Message Length	Minimum (2 - 80) *4	I25MIN##	72
	Maximum (2 - 80) *80	I25MAX##	72
NEC 2 of 5	Default All NEC 2 of 5 Settings	N25DFT	72
	Off	N25ENAO	72
	*On	N25ENA1	72
NEC 2 of 5 Check Digit	*No Check Char.	N25CK20	73
	Validate, But Don't Transmit	N25CK21	73
	Validate and Transmit	N25CK22	73
NEC 2 of 5 Message Length	Minimum (2 - 80) *4	N25MIN##	73
	Maximum (2 - 80) *80	N25MAX##	73
Code 93	Default All Code 93 Settings	C93DFT	74
	Off	C93ENAO	74
	*On	C93ENA1	75
Code 93 Message Length	Minimum (0 - 80) *0	C93MIN##	74
	Maximum (0 - 80) *80	C93MAX##	74
Code 93 Append	On	C93APP1	75
	*Off	C93APPO	75
Code 93 Code Page	Code 93 Code Page	C93DCP	75
Straight 2 of 5 Industrial	Default All Straight 2 of 5 Industrial Settings	R25DFT	75
	*Off	R25ENAO	75
	On	R25ENA1	75
Straight 2 of 5 Industrial Message Length	Minimum (1 - 48) *4	R25MIN##	76
	Maximum (1 - 48) *48	R25MAX##	76
Straight 2 of 5 IATA	Default All Straight 2 of 5 IATA Settings	A25DFT	76
Straight 2 of 5 IATA	*Off	A25ENAO	76
	On	A25ENA1	76
Straight 2 of 5 IATA Message Length	Minimum (1 - 48) *4	A25MIN##	76
	Maximum (1 - 48) *48	A25MAX##	77
Matrix 2 of 5	Default All Matrix 2 of 5 Settings	X25DFT	77
	*Off	X25ENAO	77
	On	X25ENA1	77

Selection	Setting * Indicates default	Serial Command # Indicates a numeric entry	Page
Matrix 2 of 5 Message Length	Minimum (1 - 80) *4	X25MIN##	77
	Maximum (1 - 80) *80	X25MAX##	77
Code 11	Default All Code 11 Settings	C11DFT	78
	*Off	C11ENAO	78
	On	C11ENA1	78
Code 11 Check Digits Required	1 Check Digit	C11CK20	78
	*2 Check Digits	C11CK21	78
Code 11 Message Length	Minimum (1 - 80) *4	C11MIN##	78
	Maximum (1 - 80) *80	C11MAX##	78
Code 128	Default All Code 128 Settings	128DFT	79
	Off	128ENAO	79
	*On	128ENA1	79
ISBT Concatenation	*Off	ISBENAO	79
	On	ISBENA1	79
Code 128 Message Length	Minimum (0 - 80) *0	128MIN##	80
	Maximum (0 - 80) *80	128MAX##	80
Code 128 Append	*On	128APP1	79
	Off	128APP0	80
Code 128 Code Page	Code 128 Code Page (*2)	128DCP##	80
GS1-128	Default All GS1-128 Settings	GS1DFT	81
	*On	GS1ENA1	81
	Off	GS1ENAO	81
GS1-128 Message Length	Minimum (1 - 80) *1	GS1MIN##	81
	Maximum (0 - 80) *80	GS1MAX##	81
UPC-A	Default All UPC-A Settings	UPADFT	82
	Off	UPAENAO	82
	*On	UPAENA1	82
UPC-A Check Digit	Off	UPACKX0	82
	*On	UPACKX1	82
UPC-A Number System	Off	UPANSX0	83
	*On	UPANSX1	82
UPC-A 2 Digit Addenda	*Off	UPAAD20	83
	On	UPAAD21	83
UPC-A 5 Digit Addenda	*Off	UPAAD50	83
	On	UPAAD51	83
UPC-A Addenda Required	*Not Required	UPAARQ0	83
	Required	UPAARQ1	83

Selection	Setting * Indicates default	Serial Command # Indicates a numeric entry	Page
UPC-A Addenda Separator	Off	UPAADS0	84
	*On	UPAADS1	84
UPC-A/EAN-13 with Extended Coupon Code	*Off	CPNENA0	84
	Allow Concatenation	CPNENA1	84
	Require Concatenation	CPNENA2	84
Coupon GS1 DataBar Output	GS1 Output Off	CPNGS10	85
	GS1 Output On	CPNGS11	85
UPC-E0	Default All UPC-E Settings	UPEDFT	85
	Off	UPEEN00	85
	*On	UPEEN01	85
UPC-E0 Expand	*Off	UPEEXP0	86
	On	UPEEXP1	85
UPC-E0 Addenda Required	Required	UPEARQ1	86
	*Not Required	UPEARQ0	86
UPC-E0 Addenda Separator	*On	UPEADS1	86
	Off	UPEADS0	86
UPC-E0 Check Digit	Off	UPECKX0	86
	*On	UPECKX1	86
UPC-E0 Number System	Off	UPENSX0	87
	*On	UPENSX1	87
UPC-E0 Addenda	2 Digit Addenda On	UPEAD21	87
	*2 Digit Addenda Off	UPEAD20	87
	5 Digit Addenda On	UPEAD51	87
	*5 Digit Addenda Off	UPEAD50	87
UPC-E1	*Off	UPEEN10	88
	On	UPEEN11	87
EAN/JAN-13	Default All EAN/JAN Settings	E13DFT	88
	Off	E13ENA0	88
	*On	E13ENA1	88
EAN/JAN-13 Check Digit	Off	E13CKX0	89
	*On	E13CKX1	88
EAN/JAN-13 2 Digit Addenda	2 Digit Addenda On	E13AD21	89
	*2 Digit Addenda Off	E13AD20	89
	5 Digit Addenda On	E13AD51	89
	*5 Digit Addenda Off	E13AD50	89
EAN/JAN-13 Addenda Required	*Not Required	E13ARQ0	90
	Required	E13ARQ1	89

Selection	Setting * Indicates default	Serial Command # Indicates a numeric entry	Page
EAN/JAN-13 Addenda Separator	Off	E13ADS0	90
	*On	E13ADS1	90
ISBN Translate	*Off	E13ISB0	90
	On	E13ISB1	90
EAN/JAN-8	Default All EAN/JAN 8 Settings	EA8DFT	91
	Off	EA8ENA0	91
	*On	EA8ENA1	91
EAN/JAN-8 Check Digit	Off	EA8CKX0	91
	*On	EA8CKX1	91
EAN/JAN-8 Addenda	*2 Digit Addenda Off	EA8AD20	91
	2 Digit Addenda On	EA8AD21	91
	*5 Digit Addenda Off	EA8AD50	92
	5 Digit Addenda On	EA8AD51	92
EAN/JAN-8 Addenda Required	*Not Required	EA8ARQ0	92
	Required	EA8ARQ1	92
EAN/JAN-8 Addenda Separator	Off	EA8ADS0	92
	*On	EA8ADS1	92
MSI	Default All MSI Settings	MSIDFT	93
	*Off	MSIENA0	93
	On	MSIENA1	93
MSI Check Character	*Validate Type 10, but Don't Transmit	MSICHK0	93
	Validate Type 10 and Transmit	MSICHK1	93
	Validate 2 Type 10 Chars, but Don't Transmit	MSICHK2	93
	Validate 2 Type 10 Chars and Transmit	MSICHK3	94
	Validate Type 10 then Type 11 Char, but Don't Transmit	MSICHK4	94
	Validate Type 10 then Type 11 Char and Transmit	MSICHK5	94
	Disable MSI Check Characters	MSICHK6	94
MSI Message Length	Minimum (4 - 48) *4	MSIMIN##	94
	Maximum (4 - 48) *48	MSIMAX##	94
GS1 DataBar Omnidirectional	Default All GS1 DataBar Omnidirectional Settings	RSSDFT	94
	Off	RSENA0	94
	*On	RSENA1	94
GS1 DataBar Limited	Default All GS1 DataBar Limited Settings	RSLDFT	95
	Off	RSENA0	95
	*On	RSENA1	95

Selection	Setting * Indicates default	Serial Command # Indicates a numeric entry	Page
GS1 DataBar Expanded	Default All GS1 DataBar Expanded Settings	RSEDFT	95
	Off	RSEENAO	95
	*On	RSEENA1	95
GS1 DataBar Expanded Msg. Length	Minimum (4 - 74) *4	RSEMIN##	96
	Maximum (4 - 74) *74	RSEMAX##	96
Codablock A	Default All Codablock A Settings	CBADFT	96
	*Off	CBAENAO	96
	On	CBAENA1	96
Codablock A Msg. Length	Minimum (1 - 600) *1	CBAMIN####	96
	Maximum (1 - 600) *600	CBAMAX####	97
Codablock F	Default All Codablock F Settings	CBFDFT	97
	*Off	CBFENAO	97
	On	CBFENA1	97
Codablock F Msg. Length	Minimum (1 - 2048) *1	CBFMIN####	97
	Maximum (1 - 2048) *2048	CBFMAX####	97
PDF417	Default All PDF417 Settings	PDFDFT	98
	*On	PDFENA1	98
	Off	PDFENAO	98
PDF417 Msg. Length	Minimum (1-2750) *1	PDFMIN####	98
	Maximum (1-2750) *2750	PDFMAX####	98
MacroPDF417	*On	PDFMAC1	98
	Off	PDFMAC0	99
MicroPDF417	Default All Micro PDF417 Settings	MPDDFT	99
	On	MPDENA1	99
	*Off	MPDENA0	99
MicroPDF417 Msg. Length	Minimum (1-366) *1	MPDMIN###	99
	Maximum (1-366) *366	MPDMAX###	99
GS1 Composite Codes	On	COMENA1	100
	*Off	COMENAO	100
UPC/EAN Version	On	COMUPC1	100
	*Off	COMUPC0	100
GS1 Composite Codes Msg. Length	Minimum (1-2435) *1	COMMIN####	100
	Maximum (1-2435) *2435	COMMAX####	100

Selection	Setting * Indicates default	Serial Command # Indicates a numeric entry	Page
GS1 Emulation	GS1-128 Emulation	EANEMU1	101
	GS1 DataBar Emulation	EANEMU2	101
	GS1 Code Expansion Off	EANEMU3	101
	EAN8 to EAN13 Conversion	EANEMU4	101
	*GS1 Emulation Off	EANEMU0	101
TCIF Linked Code 39	On	T39ENA1	102
	*Off	T39ENA0	102
QR Code	Default All QR Code Settings	QRCDFT	108
	*On	QRCENA1	102
	Off	QRCENA0	102
QR Code Msg. Length	Minimum (1-7089) *1	QRCMIN####	103
	Maximum (1-7089) *7089	QRCMAX####	103
QR Code Append	*One Scan	QRCAPP1	103
	Swipe	QRCAPP2	103
	Point and Shoot	QRCAPP3	103
	Off	QRCAPP0	104
QR Code Page	QR Code Page (*3)	QRCDCP##	104
Data Matrix	Default All Data Matrix Settings	IDMDFT	104
	*On	IDMENA1	104
	Off	IDMENA0	104
Data Matrix Msg. Length	Minimum (1-3116) *1	IDMMIN####	105
	Maximum (1-3116) *3116	IDMMAX####	105
Data Matrix Code Page	Data Matrix Code Page (*51)	IDMDCP##	105
MaxiCode	Default All MaxiCode Settings	MAXDFT	105
	On	MAXENA1	105
	*Off	MAXENA0	105
MaxiCode Msg. Length	Minimum (1-150) *1	MAXMIN###	106
	Maximum (1-150) *150	MAXMAX###	106
Aztec Code	Default All Aztec Code Settings	AZTDFT	106
	*On	AZTENA1	106
	Off	AZTENA0	106
Aztec Code Msg. Length	Minimum (1-3832) *1	AZTMIN####	106
	Maximum (1-3832) *3832	AZTMAX####	107
Aztec Append	*One Scan	AZTAPP1	107
	Swipe	AZTAPP2	107
	Point and Shoot	AZTAPP3	107
	*Off	AZTAPP0	107

Selection	Setting * Indicates default	Serial Command # Indicates a numeric entry	Page
Aztec Code Page	Aztec Code Page (*51)	AZTDCP##	108
Chinese Sensible (Han Xin) Code	Default All Han Xin Code Settings	HX_DFT	108
	On	HX_ENA1	108
	*Off	HX_ENA0	108
Chinese Sensible (Han Xin) Code Msg. Length	Minimum (1-7833) *1	HX_MIN####	108
	Maximum (1-7833) *7833	HX_MAX####	108
Postal Codes - 2D			
2D Postal Codes	*Off	POSTAL0	109
Single 2D Postal Codes	Australian Post On	POSTAL1	109
	British Post On	POSTAL7	109
	Canadian Post On	POSTAL30	109
	Intelligent Mail Bar Code On	POSTAL10	109
	Japanese Post On	POSTAL3	109
	KIX Post On	POSTAL4	109
	Planet Code On	POSTAL5	109
	Postal-4i On	POSTAL9	109
	Postnet On	POSTAL6	110
	Postnet with B and B' Fields On	POSTAL11	110
	InfoMail On	POSTAL2	110
Combination 2D Postal Codes	InfoMail and British Post On	POSTAL8	110
	Intelligent Mail Bar Code and Postnet with B and B' Fields On	POSTAL20	110
	Postnet and Postal-4i On	POSTAL14	110
	Postnet and Intelligent Mail Bar Code On	POSTAL16	110
	Postal-4i and Intelligent Mail Bar Code On	POSTAL17	110
	Postal-4i and Postnet with B and B' Fields On	POSTAL19	110
	Planet and Postnet On	POSTAL12	111
	Planet and Postnet with B and B' Fields On	POSTAL18	111
	Planet and Postal-4i On	POSTAL13	111
	Planet and Intelligent Mail Bar Code On	POSTAL15	111
	Planet, Postnet, and Postal-4i On	POSTAL21	111
	Planet, Postnet, and Intelligent Mail Bar Code On	POSTAL22	111
	Planet, Postal-4i, and Intelligent Mail Bar Code On	POSTAL23	111
	Postnet, Postal-4i, and Intelligent Mail Bar Code On	POSTAL24	111

Selection	Setting * Indicates default	Serial Command # Indicates a numeric entry	Page
	Planet, Postal-4i, and Postnet with B and B' Fields On	POSTAL25	111
	Planet, Intelligent Mail Bar Code, and Postnet with B and B' Fields On	POSTAL26	111
	Postal-4i, Intelligent Mail Bar Code, and Postnet with B and B' Fields On	POSTAL27	112
	Planet, Postal-4i, Intelligent Mail Bar Code, and Postnet On	POSTAL28	112
	Planet, Postal-4i, Intelligent Mail Bar Code, and Postnet with B and B' Fields On	POSTAL29	112
Planet Code Check Digit	Transmit	PLNCKX1	112
	*Don't Transmit	PLNCKX0	112
Postnet Check Digit	Transmit	NETCKX1	112
	*Don't Transmit	NETCKX0	112
Australian Post Interpretation	Bar Output	AUSINT0	113
	Numeric N Table	AUSINT1	113
	Alphanumeric C Table	AUSINT2	113
	Combination N and C Tables	AUSINT3	113
Postal Codes - Linear			
China Post (Hong Kong 2 of 5)	Default All China Post (Hong Kong 2 of 5) Settings	CPCDFT	113
	*Off	CPCENAO	114
	On	CPCENA1	114
China Post (Hong Kong 2 of 5) Msg. Length	Minimum (2 - 80) *4	CPCMIN##	114
	Maximum (2 - 80) *80	CPCMAX##	114
Korea Post	Default All Korea Post Settings	KPCDFT	114
	*Off	KPCENAO	114
	On	KPCENA1	114
Korea Post Msg. Length	Minimum (2 - 80) *4	KPCMIN##	115
	Maximum (2 - 80) *48	KPCMAX##	115
Korea Post Check Digit	Transmit Check Digit	KPCCHK1	115
	*Don't Transmit Check Digit	KPCCHK0	115
Utilities			
Add Code I.D. Prefix to All Symbolologies (Temporary)		PRECA2,BK2995C80!	117
Show Software Revision		REVINF	117
Reset the Factory Defaults	Remove Custom Defaults	DEFOVR	119
	Activate Defaults	DEFALT	119

HF680 Scanner Product Specifications

Parameter	Specification
Mechanical	
Length	3.35 in. (85mm)
Width	3.46 in. (88mm)
Height	5.47 in. (139mm)
Weight	9.8 oz.±0.3 (278g±10)
Electrical	
Input Voltage	5 VDC ±0.5V
Operating Power	2.0W (400mA @ 5V)
Standby Power	.85W (170mA @ 5V)
Host System Interfaces	USB, RS-232
Environmental	
Operating Temperature	14°F to 104°F (-10°C to 40°C)
Storage Temperature	-40°F to 140°F (-40°C to 60°C)
Humidity	0 to 95% non-condensing
Drop	Designed to withstand 3.3 ft. (1m) drops
Light Levels	0 to 100,000 lux (9,290 foot-candles)
Image	
Image Size	1280 x 800 pixels
Scan Performance	
Scan Angle	47° horizontal, 30° vertical
Contrast	20% minimum reflectance difference
Pitch, Skew	60°, 70°

Depth of Field Charts

Typical Performance

Focus			
Symbology		Near Distance	Far Distance
5 mil Code 39	in.	0	3.94
	mm	0	100
6.7 mil PDF	in.	0	4.33
	mm	0	110
10 mil Data Matrix	in.	0	3.54
	mm	0	90
13 mil UPC-A	in.	0	8.27
	mm	0	210
20 mil Code 39	in.	0	11.81
	mm	0	300
20 mil QR Code	in.	0	8.27
	mm	0	210

Guaranteed Performance

Focus			
Symbology		Near Distance	Far Distance
5 mil Code 39	in.	0.39	2.76
	mm	10	70
6.7 mil PDF	in.	0	3.15
	mm	0	80
10 mil Data Matrix	in.	0.2	3.15
	mm	5	80
13 mil UPC-A	in.	0	6.5
	mm	0	165
20 mil Code 39	in.	0	8.66
	mm	0	220
20 mil QR Code	in.	0	7.09
	mm	0	180
*Resolution: 1D: 3mil 2D: 6.7 mil *Performance may be impacted by barcode quality.			

Standard Cable Pinouts

Note: The following pin assignments are not compatible with Honeywell legacy products. Use of a cable with improper pin assignments may lead to damage to the unit. Use of any cables not provided by the manufacturer may result in damage not covered by your warranty.

Serial Output

10 Pin RJ41 Modular Plug

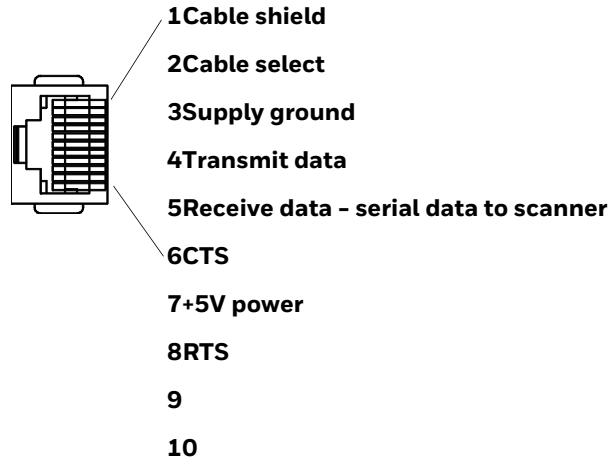

USB

10 Pin Modular Plug

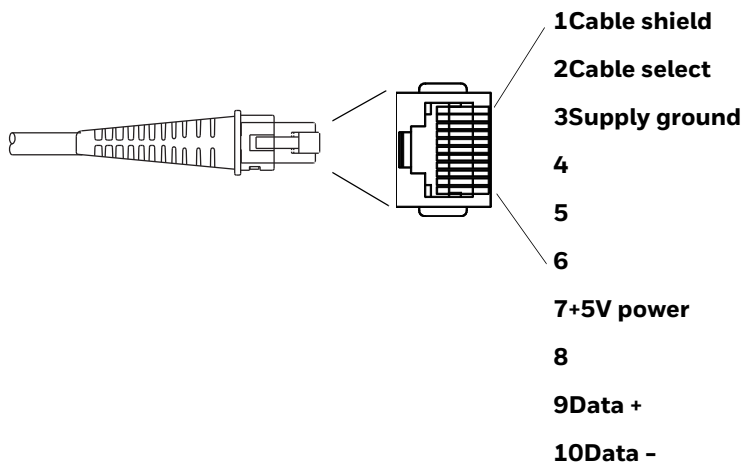

Required Safety Labels

HF680 Scanner

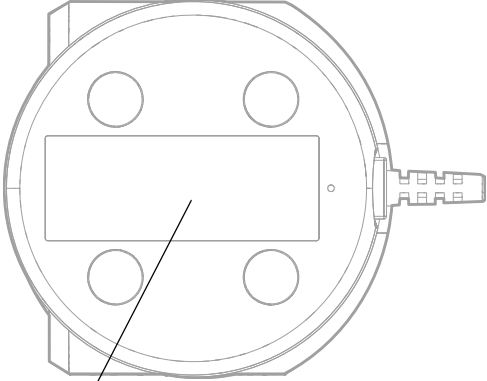

**Part Number, Serial Number
Label, and Revision
Information location**

MAINTENANCE AND TROUBLESHOOTING

Repairs

Repairs and/or upgrades are not to be performed on this product. These services are to be performed only by an authorized service center (see [Customer Support](#) on page ix).

Maintenance

Your device provides reliable and efficient operation with a minimum of care. Although specific maintenance is not required, the following sections describe periodic checks to ensure dependable operation.

Clean the Scanner

The scanner and scanner window may be cleaned with a soft cloth dampened with water or a mild detergent-water solution. If a mild detergent solution is used, wipe the scanner or base with a clean cloth dampened only with water to remove any detergent residue.

Note: *Reading performance may degrade if the scanner's window is not clean. If the window is visibly dirty, or if the scanner isn't operating well, clean the window.*



Caution: **Do not submerge the scanner in water or cleaning solution. Do not use abrasive wipes or cloths on the scanner's window. Abrasive wipes may scratch the window. Never use solvents (e.g., acetone) on the housing or window. Solvents may damage the finish or the window.**

Caution: **Ensure all components are dry prior to mating the scanner with charging accessories or other peripheral devices. Mating wet components may cause damage not covered by the warranty.**

Inspect Cords and Connectors

Inspect the interface cable and connector for wear or other signs of damage. A badly worn cable or damaged connector may interfere with scanner operation. Contact your distributor for information about cable replacement. Cable replacement instructions are on [page 148](#).

Replace Cables

The standard interface cable is attached to the scanner with an 10-pin modular connector. When properly seated, the connector is held in the scanner's handle by a flexible retention tab. The interface cable is designed to be field replaceable.

- Order replacement cables from Honeywell or from an authorized distributor.
- When ordering a replacement cable, specify the cable part number of the original interface cable.

Replace an Interface Cable

1. Turn the power to the host system OFF.
2. Disconnect the scanner's cable from the terminal or computer.
3. Locate the small hole on the back of the scanner's handle. This is the cable release.
4. Straighten one end of a paper clip.
5. Insert the end of the paper clip into the small hole and press in. This depresses the retention tab, releasing the connector. Pull the connector out while maintaining pressure on the paper clip, then remove the paper clip.
6. Replace with the new cable.
Insert the connector into the opening and press firmly. The connector is keyed to go in only one way, and will click into place.

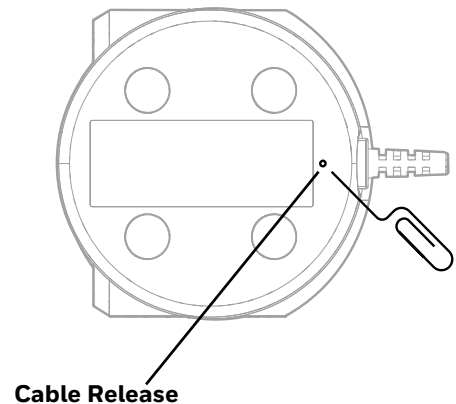

Troubleshoot

The scanner automatically performs self-tests whenever you turn it on. If your scanner is not functioning properly, review the following Troubleshooting Guide to try to isolate the problem.

Is the power on? Is the aimer on?

If the aimer isn't illuminated, check that:

- The cable is connected properly.
- The host system power is on (if external power isn't used).
- The trigger works.

Is the scanner having trouble reading your symbols?

If the scanner isn't reading symbols well, check that the symbols:

- Aren't smeared, rough, scratched, or exhibiting voids.
- Aren't coated with frost or water droplets on the surface.
- Are enabled in the scanner or in the decoder to which the scanner connects.

Is the barcode displayed but not entered?

The barcode is displayed on the host device correctly, but you still have to press a key to enter it (the Enter/Return key or the Tab key, for example).

- You need to program a suffix. Programming a suffix enables the scanner to output the barcode data plus the key you need (such as "CR") to enter the data into your application. Refer to [Prefix/Suffix Overview](#) beginning on page 43 for further information.

If you aren't sure what programming options have been set in the scanner, or if you want the factory default settings restored, refer to [Reset the Custom Defaults](#) on page 125.

REFERENCE CHARTS

Symbology Charts

Note: “m” represents the AIM modifier character. Refer to *International Technical Specification, Symbology Identifiers*, for AIM modifier character details.

Prefix/Suffix entries for specific symbologies override the universal (All Symbologies, 99) entry.

Refer to [Data Edit](#) beginning on page 43 and [Data Format](#) beginning on page 49 for information about using Code ID and AIM ID.

Linear Symbologies

Symbology	AIM		Honeywell	
	ID	Possible modifiers (m)	ID	Hex
All Symbologies				99
Codabar	JFm	0-1	a	61
Code 11	JH3		h	68
Code 128	JCm	0, 1, 2, 4	j	6A
Code 32 Pharmaceutical (PARAF)	JX0		<	3C
Code 39 (supports Full ASCII mode)	JAm	0, 1, 3, 4, 5, 7	b	62
TCIF Linked Code 39 (TLC39)	JL2		T	54
Code 93 and 93i	JGm	0-9, A-Z, a-m	i	69
EAN	JEm	0, 1, 3, 4	d	64
EAN-13 (including Bookland EAN)	JE0		d	64
EAN-13 with Add-On	JE3		d	64
EAN-13 with Extended Coupon Code	JE3		d	64
EAN-8	JE4		D	44

Symbology	AIM		Honeywell	
	ID	Possible modifiers (m)	ID	Hex
EAN-8 with Add-On	JE3		D	44
GS1				
GS1 DataBar	jem	0	y	79
GS1 DataBar Limited	jem		{	7B
GS1 DataBar Expanded	jem		}	7D
GS1-128	JC1		l	49
2 of 5				
China Post (Hong Kong 2 of 5)	JX0		Q	51
Interleaved 2 of 5	Jlm	0, 1, 3	e	65
Matrix 2 of 5	JX0		m	6D
NEC 2 of 5	JX0		Y	59
Straight 2 of 5 IATA	JRm	0, 1, 3	f	66
Straight 2 of 5 Industrial	JS0		f	66
MSI	JMm	0, 1	g	67
Telepen	JBm		t	74
UPC		0, 1, 2, 3, 8, 9, A, B, C		
UPC-A	JE0		c	63
UPC-A with Add-On	JE3		c	63
UPC-A with Extended Coupon Code	JE3		c	63
UPC-E	JE0		E	45
UPC-E with Add-On	JE3		E	45
UPC-E1	JX0		E	45

Add Honeywell Code ID				5C80
Add AIM Code ID				5C81
Add Backslash				5C5C
Batch mode quantity			5	35

2D Symbologies

Symbology	AIM		Honeywell	
	ID	Possible modifiers (m)	ID	Hex
All Symbologies				99
Aztec Code]zm	0-9, A-C	z	7A

Symbology	AIM		Honeywell	
	ID	Possible modifiers (m)	ID	Hex
Chinese Sensible Code (Han Xin Code)]X0		H	48
Codablock A]06	0, 1, 4, 5, 6	V	56
Codablock F]0m	0, 1, 4, 5, 6	q	71
Code 49]Tm	0, 1, 2, 4	l	6C
Data Matrix]dm	0-6	w	77
GS1]em	0-3	y	79
GS1 Composite]em	0-3	y	79
GS1 DataBar Omnidirectional]em	0-3	y	79
MaxiCode]Um	0-3	x	78
PDF417]Lm	0-2	r	72
MicroPDF417]Lm	0-5	R	52
QR Code]Qm	0-6	s	73
Micro QR Code]Qm		s	73

Postal Symbologies

Symbology	AIM		Honeywell	
	ID	Possible modifiers (m)	ID	Hex
All Symbologies				99
Australian Post]X0		A	41
British Post]X0		B	42
Canadian Post]X0		C	43
China Post]X0		Q	51
InfoMail]X0		,	2c
Intelligent Mail barcode]X0		M	4D
Japanese Post]X0		J	4A
KIX (Netherlands) Post]X0		K	4B
Korea Post]X0		?	3F
Planet Code]X0		L	4C
Postal-4i]X0		N	4E
Postnet]X0		P	50

ASCII Conversion Chart (Code Page 1252)

In keyboard applications, ASCII Control Characters can be represented in 3 different ways, as shown below. The CTRL+X function is OS and application dependent. The following table lists some commonly used Microsoft functionality. This table applies to U.S. style keyboards. Certain characters may differ depending on your Country Code/PC regional settings.

Non-printable ASCII control characters			Keyboard Control + ASCII (CTRL+X) Mode		
DEC	HEX	Char	Control + X Mode Off (KBDCASO)	Windows Mode Control + X Mode On (KBDCAS2)	
				CTRL + X	CTRL + X function
0	00	NUL	Reserved	CTRL+ @	
1	01	SOH	NP Enter	CTRL+ A	Select all
2	02	STX	Caps Lock	CTRL+ B	Bold
3	03	ETX	ALT Make	CTRL+ C	Copy
4	04	EOT	ALT Break	CTRL+ D	Bookmark
5	05	ENQ	CTRL Make	CTRL+ E	Center
6	06	ACK	CTRL Break	CTRL+ F	Find
7	07	BEL	Enter / Ret	CTRL+ G	
8	08	BS	<i>(Apple Make)</i>	CTRL+ H	History
9	09	HT	Tab	CTRL+ I	Italic
10	0A	LF	<i>(Apple Break)</i>	CTRL+ J	Justify
11	0B	VT	Tab	CTRL+ K	hyperlink
12	0C	FF	Delete	CTRL+ L	list, left align
13	0D	CR	Enter / Ret	CTRL+ M	
14	0E	SO	Insert	CTRL+ N	New
15	0F	SI	ESC	CTRL+ O	Open
16	10	DLE	F11	CTRL+ P	Print
17	11	DC1	Home	CTRL+ Q	Quit
18	12	DC2	PrtScn	CTRL+ R	
19	13	DC3	Backspace	CTRL+ S	Save
20	14	DC4	Back Tab	CTRL+ T	
21	15	NAK	F12	CTRL+ U	
22	16	SYN	F1	CTRL+ V	Paste
23	17	ETB	F2	CTRL+ W	
24	18	CAN	F3	CTRL+ X	
25	19	EM	F4	CTRL+ Y	?
26	1A	SUB	F5	CTRL+ Z	?
27	1B	ESC	F6	CTRL+ [?
28	1C	FS	F7	CTRL+ \	?
29	1D	GS	F8	CTRL+]	?
30	1E	RS	F9	CTRL+ ^	?
31	1F	US	F10	CTRL+ -	?
127	7F	△	NP Enter		?

Lower ASCII Reference Table

Note: Windows Code page 1252 and lower ASCII use the same characters.

Printable Characters								
DEC	HEX	Character	DEC	HEX	Character	DEC	HEX	Character
32	20	<SPACE>	64	40	@	96	60	`
33	21	!	65	41	A	97	61	a
34	22	"	66	42	B	98	62	b
35	23	#	67	43	C	99	63	c
36	24	\$	68	44	D	100	64	d
37	25	%	69	45	E	101	65	e
38	26	&	70	46	F	102	66	f
39	27	'	71	47	G	103	67	g
40	28	(72	48	H	104	68	h
41	29)	73	49	I	105	69	i
42	2A	*	74	4A	J	106	6A	j
43	2B	+	75	4B	K	107	6B	k
44	2C	,	76	4C	L	108	6C	l
45	2D	-	77	4D	M	109	6D	m
46	2E	.	78	4E	N	110	6E	n
47	2F	/	79	4F	O	111	6F	o
48	30	0	80	50	P	112	70	p
49	31	1	81	51	Q	113	71	q
50	32	2	82	52	R	114	72	r
51	33	3	83	53	S	115	73	s
52	34	4	84	54	T	116	74	t
53	35	5	85	55	U	117	75	u
54	36	6	86	56	V	118	76	v
55	37	7	87	57	W	119	77	w
56	38	8	88	58	X	120	78	x
57	39	9	89	59	Y	121	79	y
58	3A	:	90	5A	Z	122	7A	z
59	3B	;	91	5B	[123	7B	{
60	3C	<	92	5C	\	124	7C	
61	3D	=	93	5D]	125	7D	}
62	3E	>	94	5E	^	126	7E	~
63	3F	?	95	5F	_	127	7F	△

Extended ASCII Characters					
DEC	HEX	CP 1252	ASCII	Alternate Extended	PS2 Scan Code
128	80	€	Ç	up arrow ↑	0x48
129	81		ü	down arrow ↓	0x50
130	82	,	é	right arrow →	0x4B
131	83	f	â	left arrow ←	0x4D
132	84	„	ä	Insert	0x52
133	85	…	à	Delete	0x53
134	86	†	å	Home	0x47
135	87	‡	ç	End	0x4F
136	88	^	ê	Page Up	0x49
137	89	‰	ë	Page Down	0x51
138	8A	Š	è	Right ALT	0x38
139	8B	<	ï	Right CTRL	0x1D

Extended ASCII Characters (Continued)

DEC	HEX	CP 1252	ASCII	Alternate Extended	PS2 Scan Code
140	8C	Œ	î	Reserved	n/a
141	8D		ï	Reserved	n/a
142	8E	Ž	Ā	Numeric Keypad Enter	0x1C
143	8F		Ă	Numeric Keypad /	0x35
144	90		É	F1	0x3B
145	91	‘	æ	F2	0x3C
146	92	’	Æ	F3	0x3D
147	93	“	ô	F4	0x3E
148	94	”	ö	F5	0x3F
149	95	•	ò	F6	0x40
150	96	–	û	F7	0x41
151	97	—	ù	F8	0x42
152	98	˜	ÿ	F9	0x43
153	99	™	Ö	F10	0x44
154	9A	š	Ü	F11	0x57
155	9B	›	ç	F12	0x58
156	9C	œ	£	Numeric Keypad +	0x4E
157	9D		¥	Numeric Keypad -	0x4A
158	9E	ž	Ps	Numeric Keypad *	0x37
159	9F	ÿ	f	Caps Lock	0x3A
160	A0		á	Num Lock	0x45
161	A1	ı	í	Left Alt	0x38
162	A2	ç	ó	Left Ctrl	0x1D
163	A3	£	ú	Left Shift	0x2A
164	A4	¤	ñ	Right Shift	0x36
165	A5	¥	Ñ	Print Screen	n/a
166	A6	ı	ª	Tab	0x0F
167	A7	§	º	Shift Tab	0x8F
168	A8	¨	¿	Enter	0x1C
169	A9	©	ƒ	Esc	0x01
170	AA	ª	¬	Alt Make	0x36
171	AB	«	½	Alt Break	0xB6
172	AC	¬	¼	Control Make	0x1D
173	AD		ı	Control Break	0x9D
174	AE	®	«	Alt Sequence with 1 Character	0x36
175	AF	™	»	Ctrl Sequence with 1 Character	0x1D
176	B0	°	␣		
177	B1	±	␣		
178	B2	²	␣		
179	B3	³	␣		
180	B4	´	␣		
181	B5	µ	␣		
182	B6	¶	␣		
183	B7	·	␣		
184	B8	¸	␣		
185	B9	¹	␣		
186	BA	º	␣		
187	BB	»	␣		
188	BC	¼	␣		
189	BD	½	␣		
190	BE	¾	␣		
191	BF	¿	␣		
192	C0	À	␣		
193	C1	Á	␣		

Extended ASCII Characters (Continued)					
DEC	HEX	CP 1252	ASCII	Alternate Extended	PS2 Scan Code
194	C2	Â	Ɽ		
195	C3	Ã	ⱥ		
196	C4	Ä	—		
197	C5	Å	ı		
198	C6	Æ	ⱦ		
199	C7	Ç	Ⱨ		
200	C8	È	ⱨ		
201	C9	É	Ⱪ		
202	CA	Ê	ⱪ		
203	CB	Ë	Ⱬ		
204	CC	Ì	ⱬ		
205	CD	Í	=		
206	CE	Î	Ɱ		
207	CF	Ï	Ɐ		
208	D0	Ð	Ɒ		
209	D1	Ñ	ⱱ		
210	D2	Ò	Ⱳ		
211	D3	Ó	ⱳ		
212	D4	Ô	ⱴ		
213	D5	Õ	Ⱶ		
214	D6	Ö	ⱶ		
215	D7	×	ⱷ		
216	D8	Ø	ⱸ		
217	D9	Ù	ⱹ		
218	DA	Ú	ⱺ		
219	DB	Û	■		
220	DC	Ü	■		
221	DD	Ý	■		
222	DE	Þ	■		
223	DF	ß	■		
224	E0	à	α		
225	E1	á	β		
226	E2	â	Γ		
227	E3	ã	π		
228	E4	ä	Σ		
229	E5	å	σ		
230	E6	æ	μ		
231	E7	ç	τ		
232	E8	è	Φ		
233	E9	é	Θ		
234	EA	ê	Ω		
235	EB	ë	δ		
236	EC	ì	∞		
237	ED	í	φ		
238	EE	î	ε		
239	EF	ï	∩		
240	F0	ð	≡		
241	F1	ñ	±		
242	F2	ò	≥		
243	F3	ó	≤		
244	F4	ô			
245	F5	õ]		
246	F6	ö	+		
247	F7	÷	≈		

Extended ASCII Characters (Continued)					
DEC	HEX	CP 1252	ASCII	Alternate Extended	PS2 Scan Code
248	F8	ø	°		
249	F9	ù	·		
250	FA	ú	·		
251	FB	û	√		
252	FC	ü	ñ		
253	FD	ý	²		
254	FE	þ	■		
255	FF	ÿ			

ISO 2022/ISO 646 Character Replacements

Code pages define the mapping of character codes to characters. If the data received does not display with the proper characters, it may be because the barcode being scanned was created using a code page that is different from the one the host program is expecting. If this is the case, select the code page with which the barcodes were created. The data characters should then appear properly.

Code Page Selection Method/ Country	Standard	Keyboard Country	Honeywell Code Page Option
United States (standard ASCII)	ISO/IEC 646-IRV	n/a	1
Automatic National Character Replacement	ISO/IEC 2022	n/a	2 (default)
Binary Code page	n/a	n/a	3
Default "Automatic National Character replacement" will select the below Honeywell Code Page options for Code128, Code 39 and Code 93.			
United States	ISO/IEC 646-06	0	1
Canada	ISO /IEC 646-121	54	95
Canada	ISO /IEC 646-122	18	96
Japan	ISO/IEC 646-14	28	98
China	ISO/IEC 646-57	92	99
Great Britain (UK)	ISO /IEC 646-04	7	87
France	ISO /IEC 646-69	3	83
Germany	ISO/IEC646-21	4	84
Switzerland	ISO /IEC 646-CH	6	86
Sweden / Finland (extended Annex C)	ISO/IEC 646-11	2	82
Ireland	ISO /IEC 646-207	73	97
Denmark	ISO/IEC 646-08	8	88
Norway	ISO/IEC 646-60	9	94
Italy	ISO/IEC 646-15	5	85
Portugal	ISO/IEC 646-16	13	92

Code Page Selection Method/ Country	Standard	Keyboard Country	Honeywell Code Page Option
Spain	ISO/IEC 646-17	10	90
Spain	ISO/IEC 646-85	51	91

Dec			35	36	64	91	92	93	94	96	123	124	125	126
Hex			23	24	40	5B	5C	5D	5E	60	7B	7C	7D	7E
US	0	1	#	\$	@	[\]	^	`	{		}	~
CA	54	95	#	\$	à	â	ç	ê	î	ô	é	ù	è	û
CA	18	96	#	\$	à	â	ç	ê	É	ô	é	ù	è	û
JP	28	98	#	\$	@	[¥]	^	`	{		}	-
CN	92	99	#	¥	@	[\]	^	`	{		}	-
GB	7	87	£	\$	@	[\]	^	`	{		}	~
FR	3	83	£	\$	à	°	ç	§	^	μ	é	ù	è	¨
DE	4	84	#	\$	§	Ä	Ö	Ü	^	`	ä	ö	ü	ß
CH	6	86	ù	\$	à	é	ç	ê	î	ô	ä	ö	ü	û
SE/FI	2	82	#	¤	É	Ä	Ö	Å	Ü	é	ä	ö	å	ü
DK	8	88	#	\$	@	Æ	Ø	Å	^	`	æ	ø	å	~
NO	9	94	#	\$	@	Æ	Ø	Å	^	`	æ	ø	å	-
IE	73	97	£	\$	Ó	É	Í	Ú	Á	ó	é	í	ú	á
IT	5	85	£	\$	§	°	ç	é	^	ù	à	ò	è	ì
PT	13	92	#	\$	§	Ã	Ç	Õ	^	`	ã	ç	õ	°
ES	10	90	#	\$	§	í	Ñ	¿	^	`	°	ñ	ç	~
ES	51	91	#	\$	·	í	Ñ	Ç	¿	`	´	ñ	ç	¨
COUNTRY	Country Keyboard	Honeywell CodePage	ISO / IEC 646 National Character Replacements											

Keyboard Key References

6E	70	71	72	73	74	75	76	77	78	79	7A	7B	7C	7D	7E					
01	02	03	04	05	06	07	08	09	0A	0B	0C	0D	0F	4B	50	55	5A	5F	64	69
10	11	12	13	14	15	16	17	18	19	1A	1B	1C	1D	4C	51	56	5B	60	65	6A
1E	1F	20	21	22	23	24	25	26	27	28	29	2B				5C	61	66	6A	
2C	2E	2F	30	31	32	33	34	35	36	37	39	53	5D	62	67	63	68	6C		
3A	3B	3C			3D				3E	3F	38	40	4F	54	59					

104 Key U.S. Style Keyboard

6E	70	71	72	73	74	75	76	77	78	79	7A	7B	7C	7D	7E					
01	02	03	04	05	06	07	08	09	0A	0B	0C	0D	0F	4B	50	55	5A	5F	64	69
10	11	12	13	14	15	16	17	18	19	1A	1B	1C	2B	4C	51	56	5B	60	65	6A
1E	1F	20	21	22	23	24	25	26	27	28	29	2A				5C	61	66	6A	
2C	2D	2E	2F	30	31	32	33	34	35	36	37	39	53	5D	62	67	63	68	6C	
3A	3B	3C			3D				3E	3F	38	40	4F	54	59					

105 Key European Style Keyboard

SAMPLE SYMBOLS

UPC-A



0 123456 7890

Interleaved 2 of 5



01234567890

EAN-13



9 780330 290951

Code 128



Code 128

Code 39

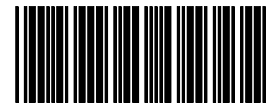

BC321

Codabar

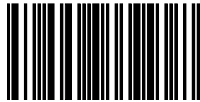

A13579B

Code 93

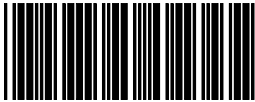

123456-9\$

Straight 2 of 5 Industrial

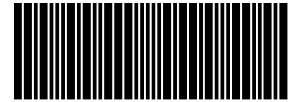

123456

Matrix 2 of 5



6543210

RSS-14



(01) 00123456789012

PDF417



Car Registration

Code 49

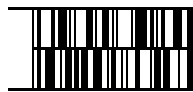

1234567890

SAMPLE SYMBOLS (CONTINUED)

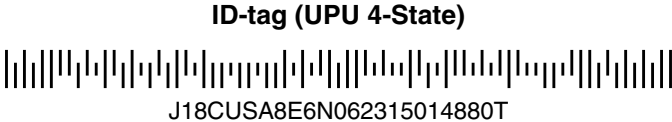
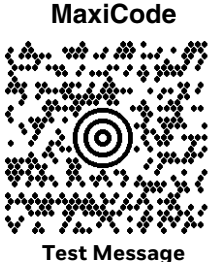

PROGRAMMING CHART



K0K
0



K2K
2



K4K
4



K6K
6



K8K
8



K1K
1



K3K
3



K5K
5



K7K
7



K9K
9

PROGRAMMING CHART (CONTINUED)



KAK
A



KBK
B



KCK
C



KDK
D



KEK
E



KFK
F



MNUSAV.
Save



MNUABT.
Discard



RESET_
Reset

Note: If you make an error while scanning the letters or digits (before scanning **Save**), scan **Discard**, scan the correct letters or digits, and **Save** again.

Honeywell
9680 Old Bailes Road
Fort Mill, SC 29707

www.honeywellaidc.com