

Honeywell

CK65 Series

Mobile Computer powered by Android™



User Guide

Disclaimer

Honeywell International Inc. (“HII”) reserves the right to make changes in specifications and other information contained in this document without prior notice, and the reader should in all cases consult HII to determine whether any such changes have been made. HII makes no representation or warranties regarding the information provided in this publication.

HII shall not be liable for technical or editorial errors or omissions contained herein; nor for incidental or consequential damages resulting from the furnishing, performance, or use of this material. HII disclaims all responsibility for the selection and use of software and/or hardware to achieve intended results.

This document contains proprietary information that is protected by copyright. All rights are reserved. No part of this document may be photocopied, reproduced, or translated into another language without the prior written consent of HII.

Copyright © 2019-2022 Honeywell International Inc. All rights reserved.

Web Address: sps.honeywell.com.

Trademarks

Google and Android are trademarks of Google LLC.

Bluetooth trademarks are owned by Bluetooth SIG, Inc., U.S.A. and licensed to Honeywell.

microSD is a registered trademark of SD-3C, LLC.

Qualcomm and Snapdragon are registered trademarks or trademarks of Qualcomm Incorporated in the United States and/or other countries.

Other product names or marks mentioned in this document may be trademarks or registered trademarks of other companies and are the property of their respective owners.

Patents

For patent information, refer to www.hsmpats.com.

TABLE OF CONTENTS

Customer Support	vii
Technical Assistance	vii
Product Service and Repair	vii
Limited Warranty	vii
Chapter 1 - About the Computer Features.....	1
About the CK65 Mobile Computer	1
Model Overview	2
Features of the CK65.....	3
CK65 Models for Use in Hazardous Locations	6
About the Battery	6
Charge the Battery Before Use.....	7
Replace the Battery.....	7
Cold Environments	8
Hot Swap.....	8
Swap Battery Mode	8
About the Battery Status.....	9
About the Battery Status LED Setting.....	9
Change the Battery Status LED Behavior	10
Check the Battery Level and Usage	11
About Battery Life and Conservation	11
Battery Recommendations and Safety Precautions	11
Enable Airplane Mode	12
Power On the Computer	12
Welcome Screen.....	13

Unlock the Screen.....	13
Change the Screen Lock to Protect the Computer.....	13
Select a Touch Screen Profile to Optimize Performance	14
Configure the Screen Backlight.....	14
About the Scan Status LED	15
About the Keypad.....	16
Keypad LEDs	17
About the Color-Coded Keys.....	18
Enter Characters on Alphanumeric Keypads	18
51-Key Keypad	18
53-Key Keypad	19
Enter Characters on Numeric Keypads	20
38-Key Keypad	20
42-Key Keypad	21
Enter Characters on the Large Numeric Keypad.....	23
About the Audio Features	24
Audio Settings	24
About CK65 Cold Storage Models.....	25
About Cold Storage Heaters	25
How Automatic Mode Works	26
How Manual Mode Works	27
Configure the Heater in the Settings App.....	27
Heater Parameters	28
Insert a microSD Card.....	29
How to Transfer Files	31
Configure USB Connection and Transfer Files	32
Accessories for the Computer.....	32

Chapter 2 - About the User Interface and Applications 35

About the User Interface.....	35
Navigation and Function Buttons	36
About Status Bar Icons	37
Remap a Button or Key.....	37

Restore Default Button Action.....	38
View and Manage Notifications.....	39
Open Quick Settings.....	39
Customize the Home Screen	39
Customize the Favorites Tray.....	40
Use Google™ Search.....	40
About Screen Gestures.....	41
Set the Time Zone.....	41
About Honeywell Applications	42
Applications You Can Download to the Mobile Computer	43
About Honeywell Enterprise Browser	43
About Honeywell Launcher.....	43
About Terminal Emulators	44
About UEMConnect	44
Unlock Developer Options.....	44

Chapter 3 - Use the Image Engine45

About the Image Engine.....	45
About the Scan Wedge Feature.....	45
Change the Scanner Settings	46
Restore Default Scan Settings	46
Default Scan Settings	47
Data Processing Settings.....	47
Symbology Settings	48
Decode Settings	48
Imager Settings	51
Trigger Settings.....	51
Notification Settings.....	52
Add a Scan Setting Profile.....	53
Delete a Scan Setting Profile	53
Change the Bluetooth Scanner Settings	53
About the Optional Digital Scan Button	54
Enable and Configure the Digital Scan Button	54
Scan Barcodes.....	54

About Scanning Configuration Barcodes.....	55
Use the Scan Demo App.....	55
Change the Scan Demo Symbology Settings	56

Chapter 4 - Use the Camera..... 57

About the Color Camera.....	57
How to Zoom	57
Take a Photo.....	57
Change Camera Settings.....	58
Record a Video	59
Change Video Settings	59
Use the Camera as a Flashlight.....	60

Chapter 5 - Configure the Computer..... 61

How to Configure the Computer.....	61
Start the Settings App	61
About the Structure of the Settings App	61
About Network Communications	71
Connect to a Wi-Fi Network	71
Configure Proxy Settings for a Wi-Fi Network	72
Disable Wi-Fi Notifications.....	72
Connect to an Ethernet Network.....	73
How to Connect to Virtual Private Networks	73
Add a VPN	73
Connect to a VPN.....	74
Edit VPN Information	74
About Wireless Security.....	74
About Certificates	75
Load a Certificate	75
Disable or Remove Certificates.....	76
About Bluetooth Communications.....	76
Connect a Bluetooth Device	76
Rename the Computer.....	77

Rename, Share or Unpair a Paired Device	77
About the Scanner Edge App	78
Connect a Bluetooth Scanner	78
Unpair a Paired Scanner	79
About Serial and USB Communications	79
USB Troubleshooting	80
About Near Field Communication (NFC)	80
Developer Information	81
About Provisioning Mode	81
Enable or Disable Provisioning Mode	81
About Wi-Fi Staging	82
Overview	82
Staging Devices.....	82
Set Up a Device as a Server.....	82
Advanced Configuration	84
Set Up Client Devices	85
Log Files	86

Chapter 6 - Manage and Maintain the Computer87

About Software Updates and Cyber Security.....	87
Software Downloads.....	87
About Transferring Files via USB Connection.....	88
Install Software with AutoInstall.....	88
Optional microSD Card Method	89
About the Honeywell Upgrader	89
View the Installed OTA Version.....	89
Install OTA Updates	90
Restart (Reboot) the Computer.....	91
About Enterprise Data Reset	92
Before You Begin.....	92
Enterprise Data Reset the Computer.....	92
About Erase All Data (Factory Reset)	93
Before You Begin.....	93

Erase All Data (Factory Reset).....	93
Repairs	94
Maintenance.....	94
Clean the Computer	94
About Disinfectant-Ready Models	95
How to Identify Models with DR Housing	95

Appendix A - Specifications..... 97

Computer Agency Information.....	97
Label Locations	97
Physical and Environmental Specifications	98
Barcode Symbologies Supported.....	98
S0803 FlexRange Imager Reading Distances	99
S0803FR Imager Engine Field of View/Resolution	100
N6803 FlexRange Imager Reading Distances.....	100
N6803FR Imager Engine Field of View/Resolution	102
N6703SR Imager Engine Reading Distances	102
N6703SR Imager Engine Field of View/Resolution	103
EX20 Imager Engine Reading Distances	103
EX20 Imager Engine Field of View/Resolution	104

Customer Support

Technical Assistance

Go to honeywell.com/PSStechnicalsupport to search our knowledge base for a solution or to log into the Technical Support portal.

For our latest contact information, see honeywell.com/PSSlocations.

Product Service and Repair

Honeywell International Inc. provides service for all of its products through service centers throughout the world. Go to sps.honeywell.com, then select **Support** to find a service center near you or to get a Return Material Authorization number (RMA #) before returning a product.

For ongoing and future product quality improvement initiatives, the mobile computer comes equipped with an embedded device lifetime counter function. Honeywell may use the lifetime counter data for future statistical reliability analysis as well as ongoing quality, repair and service purposes.

Limited Warranty

For warranty information, go to sps.honeywell.com and click **Support > Warranties**.

ABOUT THE COMPUTER FEATURES

This chapter introduces the CK65 Mobile Computer. Use this chapter to learn about the basic computer features, functions, and accessories.

About the CK65 Mobile Computer

CK65 mobile computers, built on the Mobility Edge™ platform, deliver real-time connectivity, advanced data capture, and future-proof investment protection. A 4-inch touchscreen with the option to choose between an alphanumeric or numeric keypad with function keys provides the flexibility to fit current and future application environments. CK65 models are equipped for fast Wi-Fi connectivity with a WLAN 802.11a/b/g/n/ac, dual-band, MIMO radio and Bluetooth (v5.0) technology that includes Bluetooth Low Energy (BLE) support.

All standard models are available with an S0803 FlexRange™ XLR, N6803 FlexRange, or N6703SR (1D/2D) high-performance imager, or an EX20 Near/Far (1D/2D), high-performance 2D imager for long-range scanning applications up to 15.2 m (50 ft).

Honeywell offers heater-equipped cold storage CK65 versions to extend the use of the mobile computer in cold storage and freezer environments. Cold storage models can be identified by a snowflake ❄️ on the front of the computer.

Starting in January 2021, standard and cold storage CK65 models come equipped with disinfectant-ready (DR) housings. Previously, disinfectant-ready CK65 models were identified by a water droplet 💧 on the front of the computer. To learn how to identify if your CK65 computer has DR housing, see [page 95](#).

CK65 models intended for use in hazardous locations are identifiable by specific labeling on the back of the device and are excluded from the DR product line.

Note: *Throughout this manual, all versions of the mobile computer are referred to as the CK65 unless information is specific to a particular model type.*

Note: *The Settings app varies by computer model and OS version. Your computer may not include all the features shown throughout the manual.*

Model Overview

Available Features	Model CK65L0N
Android operating system*	x
2.2 GHz Qualcomm Snapdragon™ 660 octacore processor	x
2 GB/4 GB LPDDR4 RAM, 32 GB flash memory	x
High definition, bright color, outdoor-readable display with responsive multi-touch capacitive touch panel	x
Integrated ambient light sensor, accelerometer, gyroscope, and magnetometer	x
Choice of physical keypad: <ul style="list-style-type: none"> • Two alphanumeric and function keypads • Two numeric and function keypads • Large numeric and function keypad 	x
Choice of Honeywell imager: <ul style="list-style-type: none"> • S0803FR, N6803FR, or N6703SR (1D/2D) high-performance imager** • EX20 Near/Far (1D/2D) high-performance, long-range imager 	x
WLAN IEEE 802.11 a/b/g/n/ac radio; Wi-Fi certified	x
Bluetooth™ V5.0 and Bluetooth Low Energy (BLE) technology support	x
NFC technology for short-range wireless data exchange	x
Top-tier rugged specifications with IP65 and IP68 (1.5m) sealing	x
Customer-accessible microSD™ slot for removable memory cards up to 512 GB (SDXC/SDHC/SDIO-compliant)	x
Value-added software components supporting specialized imaging and OCR functions	x
13-megapixel color camera, 4K video with image stabilization and advanced software features for enhanced exposure control**	x
*For information on supported Android OS versions, see the CK65 Data Sheet, available at sps.honeywell.com . ** Camera and imager options vary for CK65 cold storage models.	

Features of the CK65

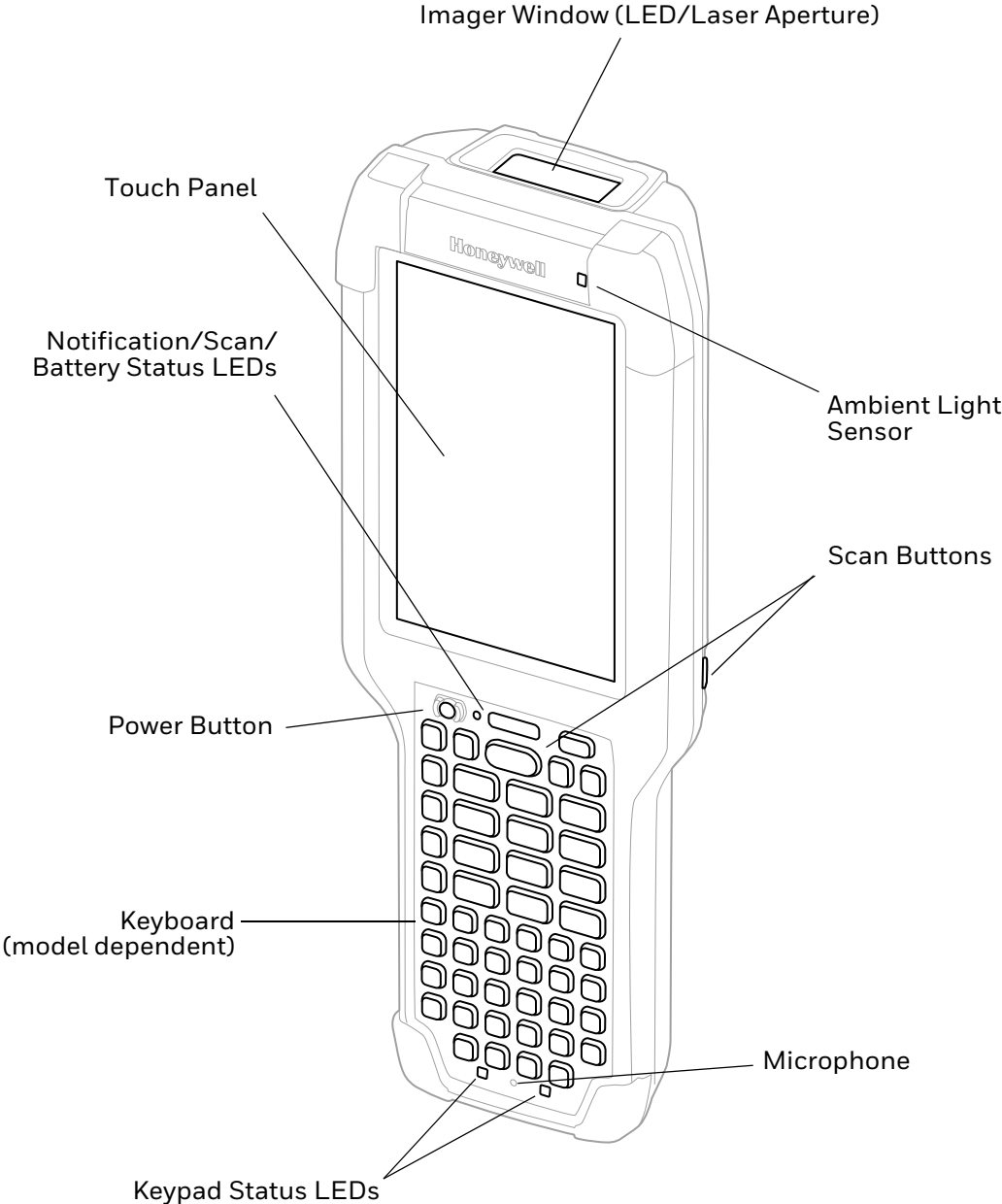

CK65 Model with S0803/N6803/N6703 Imager

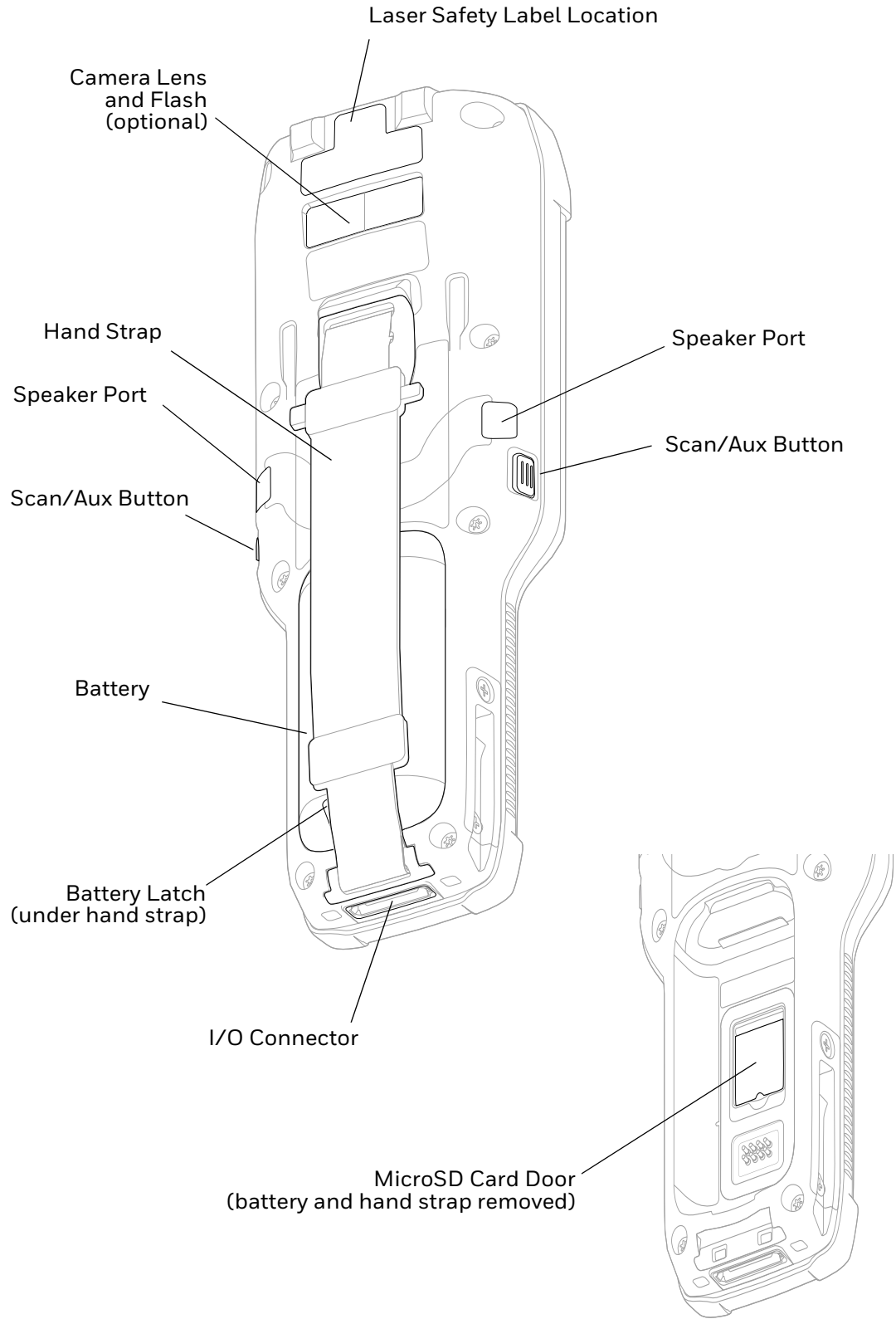

CK65 Model with EX20 Imager

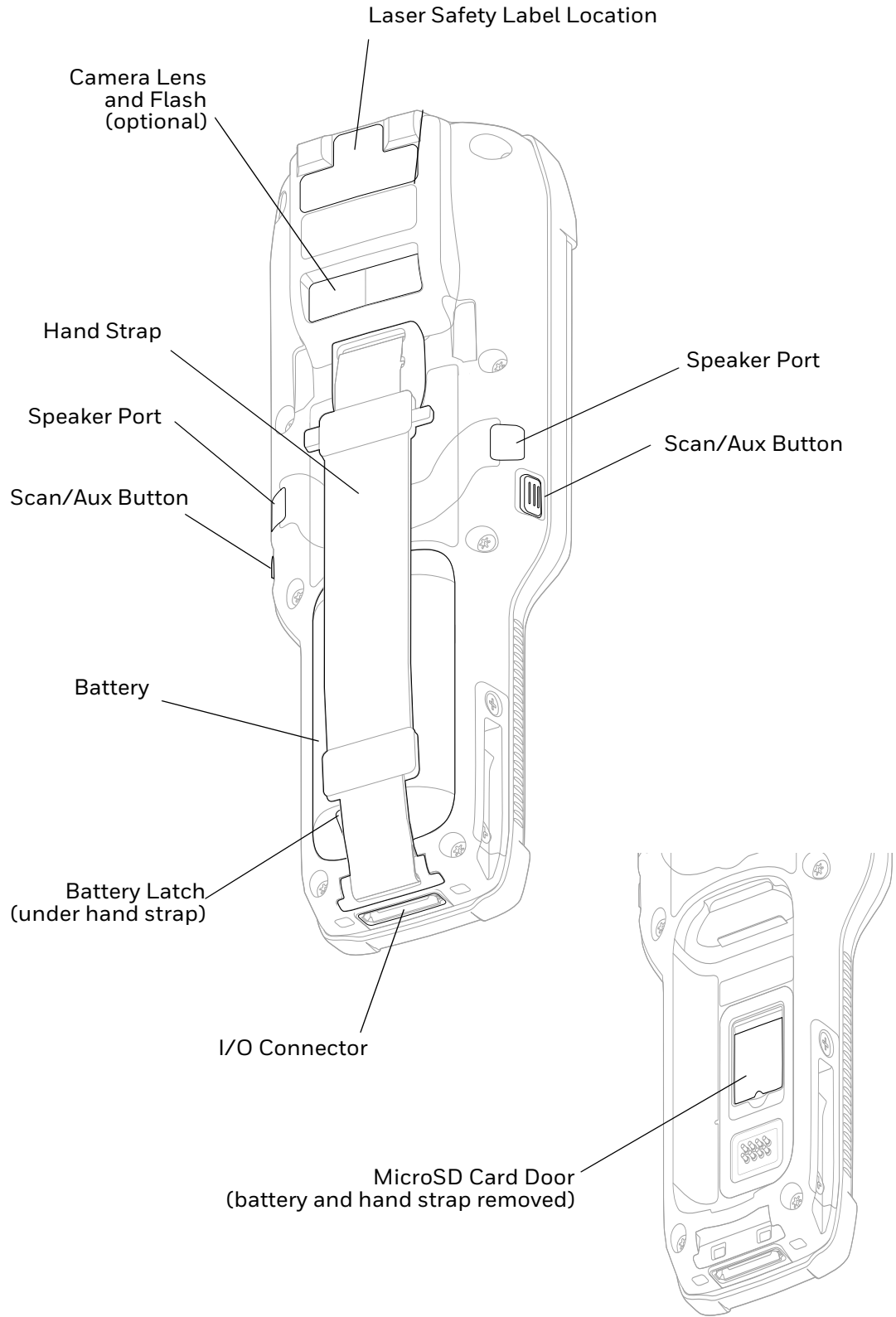

CK65 Models for Use in Hazardous Locations

An I/O cover is supplied with CK65 models marked as certified for use in hazardous environments. CK65 models intended for use in hazardous locations are identifiable by specific labeling on the back of the device.



Warning: Before you attempt to use, charge or replace the battery in CK65 models marked for use in hazardous locations, carefully read all labels, markings and product documentation provided in the box or online at sps.honeywell.com.



Warning: The I/O cover must be attached when using the CK65 in a hazardous environment.

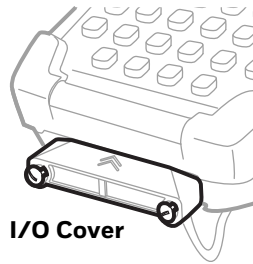

I/O Cover

About the Battery

The computer uses a rechargeable Li-ion battery as its main power source. Several factors determine the life of your battery, such as display brightness, display timeout, input device, extreme temperature, and usage. Honeywell recommends that you keep the battery charged at all times to prevent data loss.

CK65 computers are designed for use with standard battery model CK65-BTSC and cold storage battery model CK65-BTCS manufactured for Honeywell International Inc. CK3 battery models AB17, AB18, and 1001AB01 can also be used with standard CK65 models, but not with cold storage or hazardous location models. See the CK3 User Guide for more information.

Computer	Battery Model	Part Number
CK65	CK65-BTSC	318-063-001
CK65 Cold Storage ❄️	CK65-BTCS	318-063-002
CK65 Hazardous Location 🚧	CK65-BTSC	318-063-003

Note: To view specifications specific to your battery model, see the battery insert supplied with the battery.

For a list of compatible accessories for the CK65 mobile computer series and their part numbers, see the *CK65 Accessories Guide*, available for download from sps.honeywell.com. Contact your local sales representative for replacement battery ordering information.



Caution: Read **Battery Recommendations and Safety Precautions** on page 11 and all cautionary markings on the battery, charging peripheral, and device using the battery before attempting to install, use, or charge the battery.



Warning: Before you attempt to charge or replace the battery in CK65 models marked for use in hazardous locations, carefully read all labels, markings and product documentation provided in the box or online at sps.honeywell.com.

Charge the Battery Before Use

CK65 computers ship with the battery significantly discharged of power. Fully charge the battery before using your computer for the first time. You can charge the battery with a CK3 series charging accessory before or after you install the battery in the computer.

CK65 Charging Accessory	CK65-BTSC Charge Times
AC20 quad charger	up to 4 hours
AD20 single dock	up to 4 hours
AD21 Ethernet multidock	up to 4 hours
AD22 charge-only multidock	up to 4 hours
AV10 vehicle dock	up to 4 hours
DX2 or DX4 with FlexDock cup 1002UC02	up to 4 hours
Universal wall mount charger	up to 4 hours

Note: CK3 battery models AB17, AB18, and 1001AB01 can take up to 1 to 2 additional hours to reach a full charge when battery is fully discharged. See the CK3 User Guide for more information.

Note: Using the computer while charging the battery increases the time required to reach a full charge.

Replace the Battery

When battery power is low, you have the choice to either charge the battery in the computer, or replace it with another fully charged battery. Spare batteries can be purchased separately.



Caution: Ensure all components are dry prior to placing the battery in the computer terminal. Mating wet components may cause damage not covered by the warranty.

Cold Environments

When replacing a battery in a CK65 that has been used in a cold environment, either:

- Replace the battery in the computer while still in the cold environment.
- OR
- Remove the computer from the cold environment and allow it to come to room temperature before replacing the battery.



Caution: Do not store a computer in a cold environment without a battery inserted.

Hot Swap

You can replace the battery on demand provided the following conditions are met:

- The computer has been powered on for at least **4 minutes**.

AND

- You insert a new battery within 30 seconds.

Swap Battery Mode

Swap Battery mode places the computer in a low power state so that the battery can be removed for a short time.

1. Save your files and close any open applications.
2. Press and hold the **Power** button until the options menu appears.
3. Tap **Power > Swap Battery**. Follow the on-screen instructions to place the unit in battery swap mode.
4. Release the end of the hand strap at the bottom of the computer.
5. Push the battery latch toward the battery to release the lock.
6. Lift up the edge of the battery and remove it from the computer.
7. Insert the charged battery into the computer.
8. Press down on the bottom edge of the battery to engage the lock.
9. Attach the hand strap.
10. Tap **OK** when prompted.







About the Battery Status

To view detailed information on your battery, such as use statistics, amount of charge remaining, and battery health information:

1. Open the **Settings** app .
2. Select either **Battery** or **Honeywell Settings > Battery Optimizer**.

You can also use the battery icon at the top of the screen in the Status bar to see battery charge information. The icon changes depending on the charge level.

Battery Status Icons

Icon	Status
	The battery charge is at 100%.
	The battery charge is at 50%.
	The battery charge is low. You need to charge or replace the battery soon.
	The battery is critically low. You need to replace the battery now or connect the computer to a charging accessory.
	The computer is connected to external power and the battery is charging.
	There is a battery error. Install another battery. If the problem persists, contact Honeywell Technical Support.

Along with the battery icon, there is a battery status LED below the touch screen. The LED color and behavior (e.g., steady on, blinking, or off) indicates the charging status of the battery. To view status descriptions and to learn how to modify the Battery LED behavior, see [About the Battery Status LED Setting](#) on page 9.

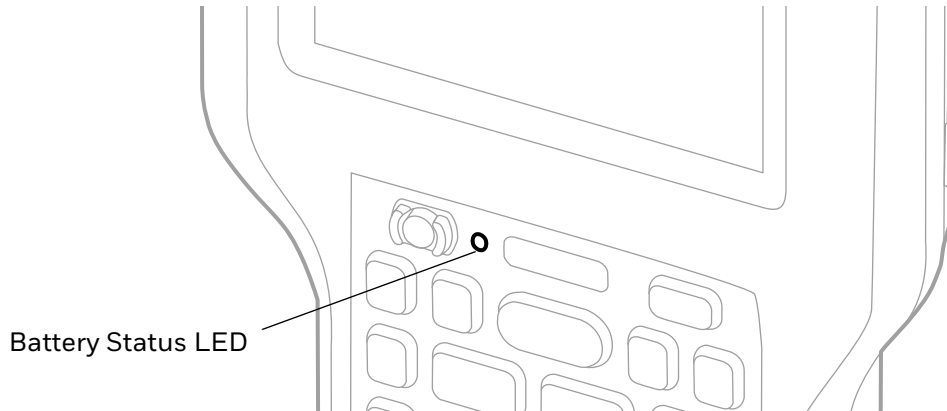

About the Battery Status LED Setting

You can change the behavior of the Battery status LED if the out-of-box behavior for a charging battery (blinking green) is not acceptable to your environment.

You can choose one of three options:

- **Honeywell Battery LED** (factory default, out-of-box configuration)
- **Default Battery LED** (optional Android OS configuration)
- **No Battery LED**

Honeywell Battery LED Behavior (Factory Default/Out-of-Box Configuration)

Connected to Power	LED State	Description
No	Blinking amber	Battery level is below 15%
No	Off	Battery level is more than 15%
Yes	Steady amber	Battery level is between 0% and 60%
Yes	Blinking green	Battery level is between 60% and 95%
Yes	Steady green	Battery level is above 95%
Either	Blinking red	Battery error

Default Battery LED Behavior (Optional Android OS Configuration)

Connected to Power	LED State	Description
No	Blinking red	Battery level is below 15%
No	Off	Battery level is 15% or more
Yes	Steady red	Battery level is below 15%
Yes	Steady amber	Battery level is between 15% and 90%
Yes	Steady green	Battery level is 90% or more

Select the No battery LED setting if you want to use the LED as a notification LED for applications or device management solutions. For more information on how to use the LED as a notification LED, see <http://developer.android.com/guide/topics/ui/notifiers/notifications.html>.

Change the Battery Status LED Behavior

To change the battery status LED behavior:

1. Swipe up from the bottom of the Home screen to access all apps.
2. Tap **Settings**  > **Honeywell Settings** > **Battery LED**.
3. Choose one of the options:
 - **Default Battery LED** (optional Android OS configuration)
 - **Honeywell Battery LED** (factory default/out-of-box configuration)
 - **No Battery LED** (disable battery LED)

Check the Battery Level and Usage

In addition to the Battery status icon and LED, you can monitor the battery status from the Settings app.

1. Swipe up from the bottom of the Home screen to access all apps.
2. Tap **Settings**  > **Battery**.

The current percentage of battery power remaining and the amount of usage time left on the battery appear on the screen. A list shows the battery usage for individual apps and services. For usage details, select one of the apps or services in the list. You can also access the **Battery saver** feature from the battery screen.

About Battery Life and Conservation

If you store the battery outside of the computer for long periods of time, the battery slowly discharges. To maintain battery performance, storing the battery in a charger is recommended. Use the reference table below to learn about how to conserve battery power.

When You Want to:	Do this to Save Battery Power:
Use the computer and the low battery status icon appears or the battery light turns on.	Do one of the following: <ul style="list-style-type: none">• Connect the computer to a charging accessory.• Replace the Battery (see page 7).
Stop using the computer for 5 minutes or more.	Make sure that the low battery status icon is not on the screen and that the battery status LED is not on. Press and release the Power button to put the computer to sleep.
Store the computer for more than a day.	<ul style="list-style-type: none">• If you are storing the computer for a few days (e.g., over the weekend), install a fully charged battery or connect the computer to a power source.• If you are storing the computer for a longer period of time, remove and charge the battery. When the battery is done charging, store both the battery and the computer in a cool location.• If you store the battery for several months, recharge the battery periodically to keep it at peak performance.
Store the battery outside of the computer.	Store the batteries in a charger.

Battery Recommendations and Safety Precautions



Caution: Improper battery replacement or incompatible device usage may result in risk of burns, fire, explosion, or other hazard. Dispose of lithium-ion batteries according to local regulations. Risk of fire and burns if improperly handled. Do not open, crush, heat above 50°C (122°F) or incinerate.

- To learn more about Battery Maintenance for Portable Devices, go to honeywell.com/PSS-BatteryMaintenance.
- For maximum battery life, charge the CK65-BTSC or CK65-BTCS battery at 20 °C (68 °F) to 25 °C (77 °F) and store at 23 °C (73 °F) with a 50% charge.
- Do not store the CK65-BTSC or CK65-BTCS battery at temperatures above 60 °C (140°F). Storage above 60 °C (140°F) may damage the battery.
- Charge the battery before use. Battery ships with only a partial charge.
- See [Charge the Battery Before Use](#) on page 7 for approved charging methods. Use of this battery in other devices could result in damage to the device or battery.
- Avoid dropping the battery or computer. If you suspect that the battery or computer is damaged, send it to a Honeywell service center for inspection.
- Discarded batteries may create a safety hazard. Before disposal, cover the battery contacts with electrical insulating tape.
- Do not modify the battery or attempt to insert foreign objects into it.
- Do not solder directly to the battery contacts.
- Do not drop the battery or apply mechanical shocks or pressure to it.
- Do not disassemble or open, crush, bend or deform, puncture, shred or burn the battery.
- Do not immerse the battery pack in water or get the battery pack wet before proper installation in the computer.

Enable Airplane Mode

If you do not need to connect to any wireless networks, you can enable Airplane mode to turn Off the radios and save battery power.

1. Swipe up from the bottom of the Home screen to access all apps.
2. Tap **Settings**  > **Network & Internet**.
3. Tap the toggle button next to **Airplane mode**. An airplane icon appears in the status bar to indicate Airplane mode is turned On.

Power On the Computer

After you have fully charged and installed a battery, power on the computer for the first time:

- Press and hold the **Power** button for approximately 3 seconds, and then release the button.

Welcome Screen

The first time you power on the computer, a Welcome screen appears. Select a language and then tap **Start**. You can either scan a configuration barcode or select manual to set up the computer. To learn more about how to [Scan Barcodes](#), see [page 54](#). To learn more about configuring multiple devices using the Wi-Fi Staging app, see [page 82](#).

During the manual setup process, follow the prompts on the screen to:

- Set up the Wi-Fi network connections.
- Set the time, date, and time zone if no Wi-Fi connection is available.
- Personalize (name) the computer.
- Set up security and privacy options.

Once you complete the initial setup, the Welcome screen no longer appears when you power on the computer and **Provisioning mode** is automatically turned Off (disabled). Scanning a barcode to install applications, certificates, configuration files, and licenses on the computer is restricted when **Provisioning mode** is turned Off. To learn more [About Provisioning Mode](#) see [page 81](#).

Unlock the Screen

The screen lock automatically activates every time the computer is turned On or when the computer wakes from sleep mode.

- Swipe up from the bottom of the screen.

The level of security provided depends on the type of lock set (e.g., Swipe, Pattern, PIN, or Password). The default setting, Swipe, provides no protection against unauthorized access to your computer.

Change the Screen Lock to Protect the Computer

After you start using the computer, you should change the screen lock to prevent unauthorized persons from accessing the computer after the screen lock activates, unless they input the correct password, pin, or pattern.

The recommended setting for the Screen lock is to enable a Password lock. Use a strong password value (e.g., include numbers, characters, special characters, and mix character case).

1. Swipe up from the bottom of the Home screen to access all apps.
2. Tap **Settings**  > **Security** > **Screen lock**.

3. Choose one of the following options:
 - **None**
 - **Swipe**
 - **Pattern**
 - **PIN**
 - **Password**
4. Follow the on-screen prompts to complete the setup.
5. Exit the Settings app.

Select a Touch Screen Profile to Optimize Performance

Optimize screen interactions by selecting a touch screen profile designed specifically for your use case. For example, if you wear gloves, set the touch screen profile to Glove use enhanced for the best touch screen response.

Note: *Maximum glove thickness of 2 mm (0.08 inches) for touch screen response.*

1. Swipe up from the bottom of the Home screen to access all apps.
2. Tap **Settings**  > **Honeywell Settings** > **Touch Screen Profile**.
3. Choose one of the following options:
 - **Normal mode**
 - **Finger enhance mode**
 - **Glove enhance mode**
 - **Stylus enhance mode**
4. Exit the Settings app.

Configure the Screen Backlight

The display has an ambient light sensor that automatically adjusts the backlight intensity to conserve power and ensure the display is readable. You can also manually set the backlight intensity if you do not want to use the automated adaptive brightness feature.

1. Swipe up from the bottom of the Home screen to access all apps.
2. Tap **Settings**  > **Display**.

3. Choose one of the following options:

- To have the computer automatically adjust the brightness for your work environment, turn On the **Adaptive brightness** setting. You can tap **Adaptive brightness** to toggle the feature On or Off.
- To set the brightness level manually, verify the Adaptive brightness feature is turned Off, and then select **Brightness level**. Adjust the slider to set the brightness level.

About the Scan Status LED

The Scan Status LED indicates the read status of the imager when scanning a barcode. The Scan Status LED is located below the touch screen.

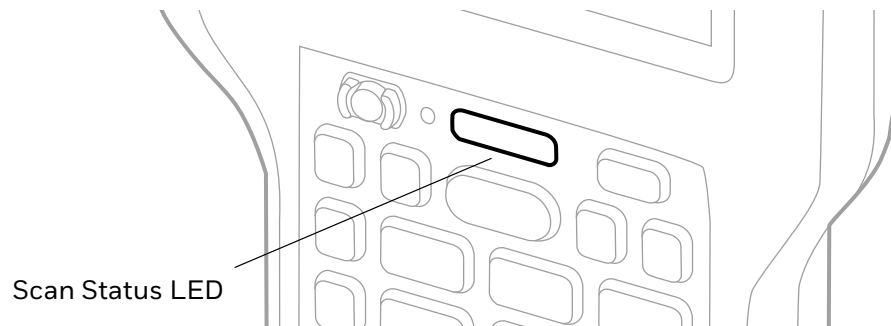

Scan Status LED Descriptions

LED Color	Description
Green	Good read of a barcode.
Red	Failure to scan barcode. Check to make sure you have the correct symbology enabled.

Note: The behavior of the Scan Status LEDs is determined by the scanning notification settings (see page 52).

To learn more about how to use and configure the imager engine for scanning, see [Use the Image Engine](#) beginning on page 45.

About the Keypad

The CK65 is available in a variety of keypad configurations.

Alphanumeric Keypads

51-Key



53-Key



Numeric Keypads

38-Key



42-Key



Large Numeric Keypad



Keypad LEDs

Special characters and alternate functions are entered by pressing color-coded key sequences. Keypad LEDs located at the bottom of the keypad, indicate when a color-coded modifier key is active. All models include both orange and green modifier keys for typing alternate characters, symbols, and functions.

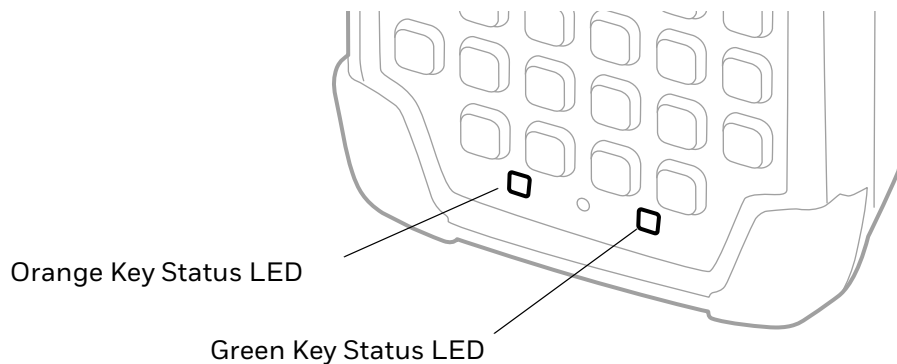

Keypad LED Descriptions

Status LED	Color	Description
Orange Modifier Key Status	Orange	Illuminated when the orange modifier key is enabled.
Green Modifier Key Status	Green	Illuminated when the green modifier key is enabled.

About the Color-Coded Keys

Use the keypad color-coded modifier key(s) to access all the characters, numbers, symbols and functions marked on the computer keys and keypad overlay.

Note: *On any keypad, you can lock the modifier key On and type only symbols or special characters by pressing the orange or green modifier key twice in rapid succession. Press the modifier key again to unlock the modifier.*

Enter Characters on Alphanumeric Keypads

51-Key Keypad

Computer models with a 51- key alphanumeric keypad include orange and green modifier keys for typing symbols and special characters. The keypad also has customizable auxiliary keys (F1 to F5) that can provide up to five additional key functions.

To learn more about customizing the key functions, see [Remap a Button or Key](#) on page 37.

To type an alphabetic character or a number:

- Press the relevant character or number key.

To type a symbol or special character:

1. Press the orange or green modifier key.
2. Press the key for the symbol or special character.

Example: Press  and then  to type a question mark.

To type a single uppercase alphabetic character:

1. Press the orange modifier key then .
A will display in the status bar to indicate that shift is On.
2. Press the character. The shift notifier in the status bar will turn Off.

Example: Press ,  then  to type the capital letter Y.

To type all uppercase alphabetic characters:

1. Press the orange modifier key then .
A will display in the status bar while caps lock is On.
2. Press the character keys.

3. Press the orange modifier key and **B** again to turn caps lock Off.

Example: Press  **B** and then **C O L D** to type the word COLD in all caps.

53-Key Keypad

The 53-key layout provides a Shift key and a Diamond key. The Diamond key provides a virtual keyboard with nine additional characters.

To type an alphabetic character or a number:

- Press the relevant character or number key.

To type a symbol or special character:

1. Press the green modifier key.
2. Press the key for the symbol or special character.

Example: Press  and then **U** to type an asterisk.

To type a single uppercase alphabetic character:

1. Press **SHIFT**.
2. Press the character.

Example: Press **SHIFT** then **Y** to type the capital letter Y.

To type all uppercase alphabetic characters:

1. Press **SHIFT** twice to turn the caps lock On.
2. Press the character keys.
3. Press **SHIFT** again to turn caps lock Off.

Example: Press **SHIFT** **SHIFT** and then **C O L D** to type the word COLD in all caps.



To type a single special character with the Diamond key:

To use the Diamond key you must first enable the virtual keyboard:

1. Swipe up from the bottom of the Home screen to access all apps.
2. Select **Settings > System > Languages & input > Physical keyboard**.
3. Enable **Show virtual keyboard**.
4. Press . A nine-character matrix of special characters displays.

5. Tap a character.

To type multiple special characters with the Diamond key:

1. If you have not already, enable the virtual keyboard (see previous section.)
2. Double-tap  to lock the Diamond key on.
3. Tap the characters.
4. Press  again to hide the matrix.

Enter Characters on Numeric Keypads

Computer models with numeric keypads include orange and green modifier keys for typing alphabetic characters and special characters as well as accessing functions. The keypads also have customizable auxiliary keys (F1 to F12) that when used in conjunction with the green modifier key can provide up to 24 additional key functions.

To learn more about customizing the key functions, see [Remap a Button or Key](#) on page 37.

38-Key Keypad

To type a number:

- Press the relevant number key.

To type a single alphabetic character or symbol:

1. Press the orange or green modifier key.
(If you press the orange key, **a** will display in the status bar to indicate that the keypad is in alphabetic mode.)
2. Press the key for the letter or special character.

Example: Press  and then  to type a lower case a.

To type multiple alphabetic characters:

1. Press the orange modifier key twice to lock it On.
a will display in the status bar.
2. Press the keys for the letters you want to input.
3. Press the orange modifier key once to return to typing numbers.

Example: Press   and then     to type the word “cold” in lower case letters.

To type a single uppercase alphabetic character:

1. Press the orange modifier key once.
a will display in the status bar.
2. Press .
- a** will change to **A** in the status bar to let you know shift is On.
3. Press the orange modifier key again.
4. Press the character key.



Example: Press    then  to type the capital letter Y by itself.

Alternately, to type a single uppercase alphabetic character with the modifier key locked on:

1. Press the orange modifier key twice to lock it On.
2. Press .
3. Press the character key.

Example: Press     then    to type the word “Cold”.

To type all uppercase characters:

1. Press the orange modifier key twice.
a will display in the status bar.
2. Press .
- a** will change to **A** in the status bar when caps lock is turned On.
3. Press the character keys.
4. Press  again to turn caps lock Off.

Example: Press    then     to type the word “COLD” in all caps.

42-Key Keypad

To type a number:

- Press the relevant number key.





To type a single alphabetic character or symbol:

1. Press the orange modifier key.
2. Press the key for the letter or special character one to four times in rapid succession depending on the position of the character illustrated on the key.

Example: Press  and then    to type a lower case c.

To type multiple alphabetic characters:

1. Press the orange modifier twice to lock it On.
2. Press the keys for the letters or special characters one to four times in rapid succession depending on the position of the character illustrated on the key.
3. Press the orange modifier key once to return to typing numbers.

Example: Press   and then           to type the word “cold” in lower case letters.

To type a single uppercase alphabetic character:

1. Press .
2. Press the orange modifier once.
3. Press the key for the letter or special character one to four times in rapid succession depending on the position of the character illustrated on the key.

Example: Press   and then    to type the capital letter Y.

To type all uppercase alphabetic characters:

1. Press  twice to turn the caps lock On.
2. Press the orange modifier twice.
3. Press the keys for the letters one to four times in rapid succession depending on the position of the character illustrated on the keys.

Example: Press     then           to type the word “COLD”.

Enter Characters on the Large Numeric Keypad

Computer models with a large numeric keypad include orange and green modifier keys for typing alphabetic characters and special characters as well as accessing functions. The keypad also has a programmable key  as well as customizable auxiliary keys (F1 to F6), which when used in conjunction with the green modifier key can provide up to 12 additional key functions.

To learn more about customizing the key functions, see [Remap a Button or Key](#) on page 37.

To type a number:

- Press the relevant number key.

To type a single alphabetic character or symbol:

1. Press the orange or green modifier key.
2. Press the key for the letter or special character one to four times in rapid succession depending on the position of the character illustrated on the key.

Example: Press  and then    to type a lower case c.

To type multiple alphabetic characters:





1. Press the orange modifier twice to lock it On.
2. Press the keys for the letters or special characters one to four times in rapid succession depending on the position of the character illustrated on the key.
3. Press the orange modifier key once to return to typing numbers.

Example: Press   and then

          to type the word “cold” in lower case letters.

To type a single uppercase alphabetic character:

1. Press the orange modifier key once.
2. Press .
A will display in the status bar.
3. Press the orange modifier key again.
4. Press the key for the letter or special character one to four times in rapid succession depending on the position of the character illustrated on the key.

Example: Press    then    to type the capital letter Y.



Alternately, to type a single uppercase alphabetic character with the modifier key locked on:

1. Press the orange modifier key twice to lock it On.
2. Press .
3. Press the key for the letter or special character one to four times in rapid succession depending on the position of the character illustrated on the key.

Example: Press    then

          to type the word “Cold”.

To type all uppercase characters:

1. Press the orange modifier key twice to lock it On.
2. Press .
A will display in the status bar.
3. Press the key for the letters or special characters one to four times in rapid succession depending on the position of the character illustrated on the key.
4. Press  again to turn caps lock Off.

Example: Press    then

          to type the word “COLD” in all caps.

About the Audio Features

The CK65 has multiple speakers, a microphone, and several software tools to configure sound volume or enable vibration feedback.

Audio Settings

This section describes the audio and sound settings you can configure in the Settings app.

- To change audio settings, select the **Settings** app  and then tap **Sound**.

Note: *Sound settings are model dependent. Some settings may not be available for your model type.*

Sound Settings

Setting	Description
Media volume	Use the sliders to set the volume for media (e.g., music, videos, and games), alarms and rings (notifications and ringtones).
Call volume	
Ring & notification volume	
Alarm volume	
Vibrate for calls	Set the phone to vibrate for incoming calls.
Do Not Disturb	Configure the Do Not Disturb feature.
Media	Show media player in Quick Settings.
Shortcut to prevent ringing	Set Press Power & Volume Up together . Options include: Vibrate, Mute, and Do Nothing.
Phone ringtone	Set the phone ringtone.
Advanced	Select to expand the settings menu.
Default notification sound	Set the default sound used for notifications.
Default alarm sound	Set the default sound used for alarms.
Other sounds and vibrations	Turn sounds On or Off for: <ul style="list-style-type: none"> • Dial pad tones • Screen locking sound • Charging sounds and vibration • Touch sounds • Touch vibration

About CK65 Cold Storage Models

CK65 cold storage (CS) models come equipped with touch screen and scan window heaters to support extended use in freezers as well as transitions into and out of freezer areas.

Note: While CK65 cold storage models are designed to be used in a wide range of cold environments, exposure to temperatures colder than -30°C (-22°F) for more than 1 hour may result in temporary readability issues.

About Cold Storage Heaters

The CK65 cold storage heaters can be set to turn On automatically to defrost the touch screen and scan window based on external temperature changes and timers or the user can control the heaters by manually turning them On or Off.

- **Automatic mode**

This is the default mode of operation for the heaters. Automatic mode maximizes battery life in cold storage environments and provides average window defrost times. In Automatic mode, cold storage battery life may

significantly exceed 8 hours (scanning a barcode every ten seconds). Window defrost times should be a minute or less with factory default settings implemented.

If your application requires faster defrost times, you can enable the **Preemptive Heating** (pre-heat) feature to minimize defrost times with average battery life in cold storage environments. This feature slightly reduces cold storage battery life since the heaters enter a low power pre-heat stage before the computer detects a rise in the ambient temperature.

In Automatic mode with **Preemptive Heating** enabled, the cold storage battery life may exceed 5 hours. The window defrost times range from zero to a maximum of one minute with factory default settings.

- **Manual mode**

This mode is disabled by default. When enabled, heater activation is controlled solely by the user. No temperature monitoring and timers are used to control the heaters. The user must manually turn the heaters On or Off.

Use the **Settings** app to configure the **Heater** feature. To learn how, see [Heater Parameters](#) on page 28.

How Automatic Mode Works

Automatic heater management saves power since the heaters are automatically controlled by the system based on cold storage entry/exit detection.

Cold Storage Entry Detection

In **Automatic** mode, cold storage entry detection occurs when the computer sensors identify a drop in ambient temperature below the defined **Heater enable temperature**. The system starts the **Chill timer** in response to cold storage entry detection.

Note: *If you remove the computer from cold storage before the Chill timer expires, the timer stops and the system does not turn On the heaters, saving battery power.*

A snowflake ❄ icon appears in the status bar when the Chill timer expires.

Cold Storage Exit Detection

In **Automatic** mode, cold storage exit detection occurs when the sensors identify a quick rise in the ambient temperature.

- If **Preemptive Heating** is disabled (default) and the **Chill time** has expired, the system turns the heaters On at full power when a cold storage exit is detected.
- If **Preemptive Heating** is enabled and the **Chill time** has expired, the system starts the **Preemptive delay time**. When the **Preemptive delay time** expires, the heaters enter a low-power pre-heat stage. Pre-heating keeps the windows warm to minimize condensation and frost when the computer is

removed from cold storage allowing for quicker defrost times. The system turns the heaters On full power when a cold storage exit is detected.

Note: When the heaters turn On, the icon changes from a snowflake ❄️ to a heater 🔥.

Turn the Heaters On/Off in Automatic Mode

When **Automatic** mode is enabled, you can still manually turn the heaters On or Off while in cold storage.

Tap the snowflake ❄️ or heater icon 🔥 in the status bar.

- If **Preemptive Heating** is disabled, the heater **Preemptive delay time** is not used and pre-heating does not automatically start, but the snowflake icon ❄️ can still be tapped to turn On the heaters for pre-heating.
- If you enabled **Preemptive Heating**, the heater **Preemptive delay time** stops when the icons are used to turn the heater On or Off.

How Manual Mode Works

Manual mode gives you full control over turning the heaters On or Off. When **Manual** mode is enabled, automatic cold storage enter/exit detection is no longer used to control the heater behavior. To turn the heaters On/Off, you must tap a button on the Heater screen in the Settings app. Full power is used for defrosting. Manual mode is disabled by default.

Turn Manual Mode On/Off

1. Swipe up from the bottom of the Home screen to access all apps.
2. Tap **Settings** > **Honeywell Settings** > **Heater**.
3. Tap the **Automatic/Manual** button to switch between the Automatic or Manual mode. The active mode appears on the button. When Manual mode is enabled, the **Heater On/Heater Off** button next to the mode button is active.
4. Tap the **Heater On/Heater Off** button to control the heaters.

Configure the Heater in the Settings App

1. Swipe up from the bottom of the Home screen to access all apps.
2. Tap **Settings**  > **Honeywell Settings** > **Heater**.
3. Modify the heater parameters.
4. Tap **Update** to apply the changes.

Heater Parameters

You can configure the following **Heater** parameters in the **Settings** app to fit your specific application environment. The list of available parameters will differ between Automatic and Manual modes.

Heater Setting	Description
Heater	Enable or Disable the Heater feature and temperature monitoring. Tap the switch button at the top of the screen to toggle the feature On or Off. The default is On.
Manual/Automatic	Tap the button to switch between Automatic mode or Manual mode. To learn more about the modes, see How Automatic Mode Works on page 26 and How Manual Mode Works on page 27.
Turn heater on when the temperature has changed by	Set the sensitivity of the cold storage exit trigger by defining a DeltaT value. To detect a cold storage exit, the computer looks for a quick rise in temperature (°C), over a brief period of time. The default DeltaT value is 0.5°C.
Duration: Heater	Set the length of time (minutes) the heaters stay On at full power (100%) once the computer detects a quick rise in temperature (DeltaT value, see above). The default value is 5 minutes. Note: <i>The heaters may turn Off before the timer has expired if a temperature reading indicates the computer is warm enough or you manually turn Off the heaters by tapping the heater icon once.</i>
Low battery threshold	Set a low battery charge threshold (%) that triggers the computer to turn Off the heaters to conserve battery power. The default value is 25%. Note: <i>Setting a value lower than the default of 25% may negatively impact device performance.</i>
Heater enabled temperature	Set the temperature (°C) that the computer must fall to before the system determines cold storage entry and heater use. Once this temperature is detected, the Chill time starts.
Chill time	Set the time limit (minutes) for how long the computer must remain at or below the defined Heater enable temperature before the system initiates one of the following actions: <ul style="list-style-type: none"> • If in Automatic mode and Preemptive Heating is disabled, the system turns the heaters on when a cold storage exit is detected (see DeltaT value). • If in Automatic mode and Preemptive Heating is enabled, the system starts the Preemptive Delay Time. <p><i>Note: If you remove the computer from cold storage before the Chill time expires, the system does not turn On the heaters, saving battery power.</i></p>
Preemptive Heating	Enable or disable Preemptive Heating (pre-heating) when Automatic mode is enabled. Tap the check box to toggle the feature On or Off.
Preemptive Duty Cycle	Set the percentage of time that the heaters are on during Preemptive Heating .

Heater Setting	Description
Preemptive Delay Time	Set the length of time (minutes) that the computer waits after the Chill time has expired before activating the low power pre-heat window feature.
Duration: Scanner heater	Set the length of time (seconds) that the scanner window heater is cycled on.
Duration: LCD heater	Set the length of time (seconds) that the touch screen heater is cycled on.
Fast monitoring interval	Set sampling interval time (seconds) used once the computer detects cold storage entry. Cold storage entry is defined by the Heater enabled temperature .
Slow monitoring interval	Set sampling interval time (seconds) used once the computer detects cold storage exit (defined by DeltaT value).
Power on time	Set the length of time (milliseconds) between turning on heater power and enabling a heater element. The default value is 10ms.
Disable temperature	Set the temperature limit (°C) that triggers turning off the heater.
Blanking	Tap check box to enable or disable heater operation during scanning.
Update	Tap to apply changes made to settings.
Default	Tap to set the Heater settings back to their default values.

Insert a microSD Card

You can use a microSD card to increase file storage capacity or to install software. Honeywell recommends the use of Single Level Cell (SLC) industrial grade microSD or microSDHC memory cards with the computer for maximum performance and durability.

Note: *Format the memory card before initial use.*

1. Save your files and close any open applications.
2. Press and hold the **Power** button until the options menu appears.
3. Tap **Power > Power off**.

4. Release one end of the hand strap. Slide the end of the strap toward the bottom of the unit, and then lift out the strap.

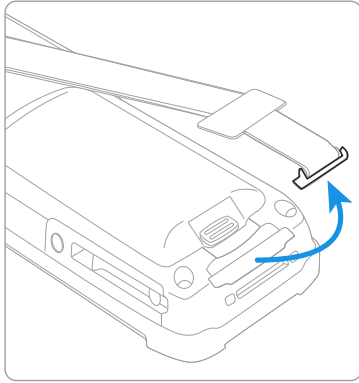

5. Press the battery latch towards the battery.
6. Lift up on the edge of the battery and remove it from the computer
7. Press down on the card access door hinge and lift the opposite end to open it.

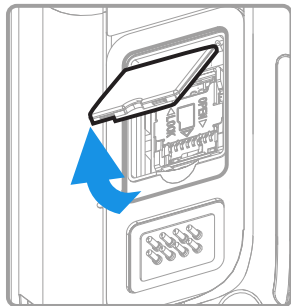

8. Press down gently and slide the card holder away from the open access door. Lift the edge of the holder up.

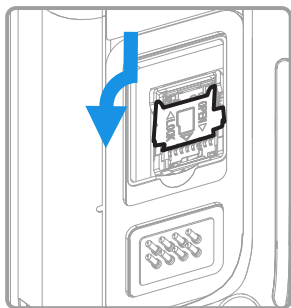

9. Insert the microSD card into the card holder with the contacts facing out.

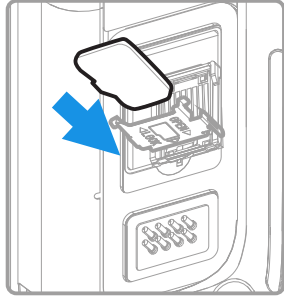

10. Close the holder with the card inserted. Press down gently on the card holder and slide it into the locked position.

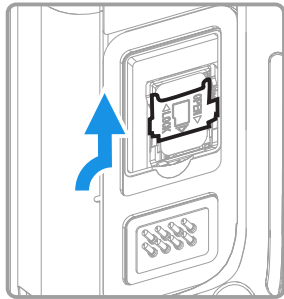

11. Close the card access door.
12. Install the battery and apply pressure to the edge closest to the battery latch.
13. Install the hand strap.
14. Press the **Power** button to turn On the computer.

How to Transfer Files

To transfer files you need to physically connect the CK65 mobile computer to your workstation (e.g., laptop or desktop computer) through a USB connection. When the mobile computer is connected and USB is configured for file or photo transfer, use a file browser (e.g., File Explorer or Windows Explorer) on your workstation to transfer files between the two computers. If you are transferring files to and from a Mac, use the Android File Transfer application (available from www.android.com/filetransfer).

Note: File transfer through a USB connection is disabled by default. You need to configure the USB connection for transferring files or photos.

You can use these accessories to connect your mobile computer to your workstation:

- Home Base or Ethernet Home Base, and a standard USB Type B to A cable

Configure USB Connection and Transfer Files

Note: The CK65 supports Hi-Speed USB communications (USB 2.0) with a maximum data transfer rate of 480 Mbps.

1. Connect the CK65 to your workstation.
2. On the CK65, swipe down from the top of the screen to see the notifications.
3. Tap the **Android System** notification twice to open the options menu.
4. Select either **File Transfer** or **PTP**.
5. Open the file browser on your workstation.
6. Browse to the CK65. You can now copy, delete, or move files between the CK65 and your workstation.

Note: When provisioning mode is disabled (turned off), some file folders are hidden from view in the file browser.

Accessories for the Computer

The CK65 ships with a hand strap and a battery. Models certified for use in hazardous locations also ship with I/O covers. All other accessories are ordered and shipped separately. The computer requires a battery to function.

For a complete list of compatible accessories for the CK65 mobile computer series and their part numbers see the CK65 Accessory Guide available for download from the CK65 product page at sps.honeywell.com.

Contact your local sales representative for ordering information.

Accessory	Description
CK65-BTSC Battery (PN 318-063-001)	Replacement or spare standard 7000 mAh Li-ion rechargeable battery for the CK65. (Not for use with cold storage or hazardous location CK65 models.)
CK65-BTCS Battery (PN 318-063-002)	Replacement or spare cold storage 5200 mAh Li-ion rechargeable battery for cold storage CK65 models.
CK65-BTSC Battery (PN 318-063-003)	Replacement or spare 7000 mAh Li-ion rechargeable battery for CK65 models certified for use in hazardous locations.
AB17, AB18, or 1001AB01 Battery (PN 318-033-021, 318-034-033, 318-046-031)	Replacement or spare Li-ion rechargeable battery for the CK65. (Not for use with cold storage CK65 models.)
AC20 Quad Battery Charger (PN 871-230-101, 871-230-301)	Charges up to four batteries at one time.
AD20 Single Dock (PN 871-228-101, 871-228-301)	Powers a CK65 and charges a spare battery separately. The single dock also provides client and host USB connectivity.
AD21 Ethernet Multidock (PN 871-229-202, 872-229-302)	Provides Ethernet connectivity and power for up to four devices.

Accessory	Description
AD22 Charge-only Multidock (PN 871-229-201, 871-229-301)	Charges up to four devices.
AV10 Vehicle Dock (PN871-231-102)	Holds and charges a CK65 while in a vehicle environment.
DX2 model 1002UU02 (PN 852-918-002)	Charges up to four batteries.
DX4 models 1002UU04 and 1002UU05 (PN 852-916-002, 852-917-002)	Charges up to four devices. Can also be configured to charge up to eight batteries. Model 1002UU05 also provides Ethernet connectivity.
Universal ChargeBase (CK65-CB-UVN)	Charges up to four devices.
Universal NetBase (CK65-NB-UVN)	Provides Ethernet connectivity and power for up to four devices.
Universal Cup (CK65-UCP-N)	Replacement cup for Universal Bases CK65-CB-UVN and CK65-NB-UVN.

ABOUT THE USER INTERFACE AND APPLICATIONS

Use this chapter to learn about the user interface and how to interact with the screen. You can also use this chapter to learn about the Honeywell applications on the computer.

About the User Interface

The Android operating system provides a touch-friendly and easy-to-navigate user interface. When you turn on the mobile computer, the Home screen is the first screen that appears after language provisioning and the startup Wizard is complete.

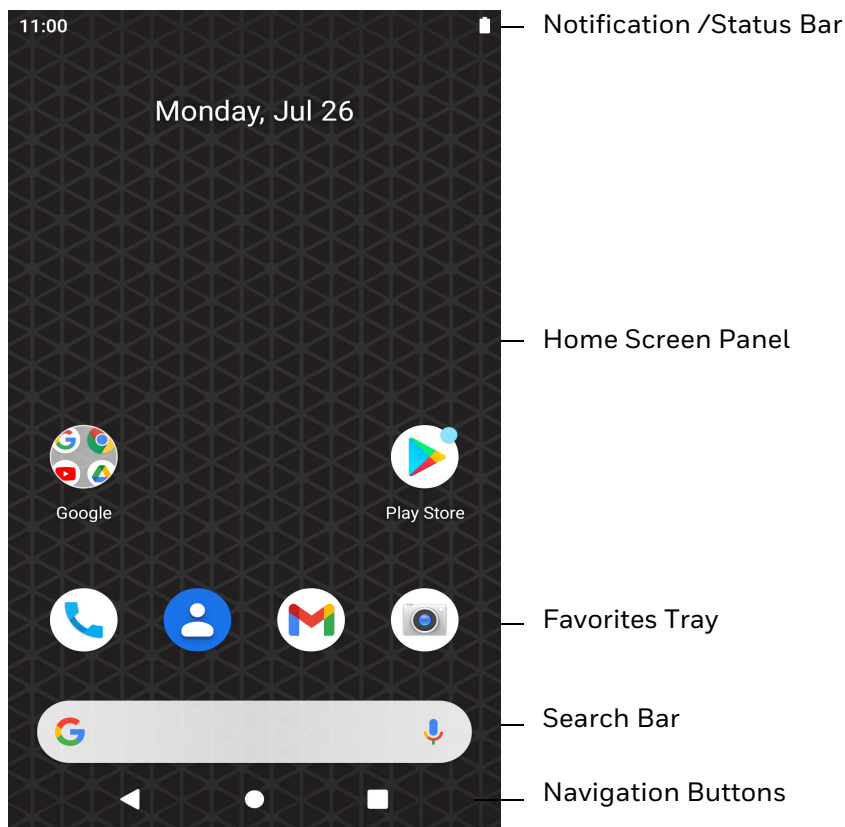

Home Screen Features











Item	Description
Notifications panel / Status bar	Status icons to the left tell you when an app has sent notifications, such as an arriving message. System icons to the right display the current wireless and network connection state and battery level.
Search bar	Search the Internet or the computer using Google™. Touch the microphone icon in the search box to initiate a voice search or command.
Home Screen panel	You can create more than one custom Home screen panel. Swipe left or right on the Home to switch between your custom panels.
Favorites tray	App icons in the customizable tray are visible on all Home screen panels.

Navigation and Function Buttons

Your mobile computer has virtual buttons on the front panel below the Favorites tray and hardware buttons located on the sides for easy navigation and quick feature access when using the computer.

For button locations on the computer, see [Features of the CK65](#) on page 3.















Navigation and Function Buttons

Button	Description	
	Back	Return to the previous screen.
	Home	Return to the Home screen.
	Recent Apps	View and switch between recently used apps.
	Scan	Press the right, left or front scan button to trigger the scanner.
	Function	Use the Key Remap feature in the Settings app to select a button function.
	FldExt	Field exit (model dependent).
	Left	Move left (model dependent).
	Right	Move right (model dependent).
	Up	Move up (model dependent).
	Down	Move down (model dependent).

About Status Bar Icons

Status and notification icons show you the current status of your network, the battery, notifications, and sounds. Use the table below to understand some of the most common icons.

Status and Notification Icons

Icon	Description	Icon	Description
	Pending alarm and Alarm is set		Airplane mode is turned On.
	New text message or multimedia message		Bluetooth is turned On.
	Error with text or multimedia message delivery		SD card is full
	New email		Wi-Fi network connected with full signal strength
	Computer is connected to a PC with a USB cable		Wi-Fi network connected but no signal strength
	Synchronizing data		Error with sync or sign-in
	The Chill timer has expired and computer is cold enough the heaters can be turned on. For more information, see About Cold Storage Heaters (page 25).		Heaters are turned on. For more information, see About Cold Storage Heaters (page 25).
	Computer is connected with Ethernet		

Remap a Button or Key

You can change the default function of the Left Scan, Right Scan, or Camera buttons as well as the Back, Recent, Home, and Search virtual buttons.

1. Swipe up from the bottom of the Home screen to access all apps.
2. Tap **Settings**  > **Honeywell Settings** > **Keyremap**.
3. Tap the plus sign (+).
4. Press the button you want to remap or select one of the virtual buttons.
5. Tap **OK**.

6. Select one of the following options:
 - Tap **Keys** to view available functions. Select the function you want assigned to the button.
 - Tap **Apps** to view available applications. Select the application you want assigned to the button.
 - Tap **Actions** to enter an Intent or Broadcast. Tap **OK** to assign the action to the button. For example, to send a Broadcast, android.intent.action.MASTER_CLEAR, or to start an Intent, com.android.settings/com.android.settings.wifi.WifiSettings.
 - Tap **Command** to enter a command that will be executed when the button is pressed. This option supports all ADB shell commands. For example, if you choose a button to remap and enter the command “input keyevent 64”, pressing the selected button will open the web browser on the device.
 - Tap **Text** to type characters to display when the remapped key is pressed. Use a comma “,” to separate the characters. Tap **OK** to assign the text to the button. Examples are listed below:



Input Text	Button Press
A,A,B	aab
SHIFT_LEFT,A,SHIFT_LEFT,B or CAPS_LOCK,A,CAPS_LOCK,B	AB
SHIFT_LEFT,1	!
CTRL_LEFT,A	(Select All)
VOLUME_UP	(Volume Up)

Note: Lower case text is not supported in the **Text** field. Text must be entered in upper case. For example, “H,e,l,l,o” will display as “h”, whereas “H.E.L.L.O” will display as “hello”.

7. Tap **Keys** or **Applications** to view the available functions.
8. The function you selected now appears next to the button name.

Restore Default Button Action

To restore the button default action:

1. Swipe up from the bottom of the Home screen to access all apps.
2. Tap **Settings**  > **Honeywell Settings** > **Keyremap**.
3. Tap the clean icon .
4. Choose the remapped button(s) you want restored to the default setting.
 - Tap the check box next to the button.

OR

- Tap **All Select** to choose all the buttons.

5. Tap **Delete**.

View and Manage Notifications

You can view recent events on the computer, manage system notifications, change a setting or quickly respond to an app notification by opening the notifications panel.

When a notification icon appears in the status bar at the top of the screen:

1. Swipe down from the top of the screen to open the notifications panel.
2. Respond to the notification. You can take one of the following actions:
 - Tap the notification to open the associated app.
 - Tap a quick-reply or action command (e.g., Reply, Archive), if available.
 - Swipe the notification sideways, off the screen to dismiss it.

Slide the notification left or right to reveal the settings icon .
Choose between **Default**, **Silent** or **Turn off notifications**.

Note: *Some notifications cannot be dismissed or turned Off.*

To close the notification panel, swipe up from the bottom of the screen, or tap the Back or Home buttons.

Open Quick Settings

Use the Quick Settings screen for easy access to common settings. Tap an icon to toggle the feature On/Off or to open additional settings.

- To open Quick Settings, swipe down twice from the status bar at the top of the screen.
- To close Quick Settings, tap the Back or Home buttons.

Customize the Home Screen

You can add application icons to any Home screen for easier access.

1. Swipe up from the bottom of the Home screen to access all apps.
2. Tap and hold the app you want to add, and then start to drag the icon out of position. The computer then switches to a smaller view of the Home screen panels.

3. Drag and drop the app icon into place.
 - If you want to add another home screen, drag the icon to the right edge of the screen before releasing the icon.
 - If you want to create a folder, drag and drop the icon on top of another icon.

Note: *If you tap and hold an app but don't move it, a shortcut menu appears. The content of the menu depends on the app selected.*

To add widgets or customize the look of the Home screen:

1. Tap and hold an empty section of the screen.
2. Select either **Wallpapers**, **Widgets** or **Home settings**.

Customize the Favorites Tray

Modify the Favorites tray to contain the apps you use the most.

1. Tap and hold the app icon you want to replace on the Favorites tray.
2. Drag and drop the app on “**X Remove**” at the top of the screen.
3. Swipe up from the bottom of the screen to access all apps.
4. Tap and hold the icon of the app you want to add.
5. Drag and drop the icon into position on the Favorites tray.

Use Google™ Search

Use the Google Search field to help you find anything you need on the computer or on the web.

1. On the Home screen, tap inside the Google Search box and begin to type your search term.

As you type, suggestions from Google web search appear below the Search box, and results from the computer (such as apps or contacts) appear below the web search results.

2. Tap a suggestion to search for it immediately, or touch the arrow to add the term to the search field without starting to search.

About Screen Gestures

Use your fingers to manipulate icons, buttons, menus, and other items on the screen.

- **Tap**

Tap to select something, toggle a setting On or Off, or activate a field for text entry.

- **Tap and hold**

Tap and hold an item but do not lift your finger until an action occurs.

- **Drag and drop**

Tap and hold an item, and then slide your finger across the screen until you reach the target position. Lift your finger off the screen to drop the item in place.

- **Swipe**

Quickly move your finger across the screen, without pausing when you first touch. For example, you can swipe a Home screen left or right to view the other Home screens.

- **Slide**

Slowly move your finger across the screen, without pausing when you first touch. For example, you can slide a notification to the left until the Settings gear is revealed.

- **Double-tap**

Tap quickly twice on a web page, map, or other screen to zoom in. Double-tap again to zoom out.

- **Pinch**

In some apps, you can zoom in and out by placing two fingers on the screen at once and pinching them together (to zoom out) or spreading them apart (to zoom in).

Set the Time Zone









The computer gets the current date and time from its network connection. If preferred, you can change this behavior and manually set the time zone for your location.



1. Swipe up from the bottom of the Home screen to access all apps.
2. Tap **Settings**  > **System** > **Date & time**.
3. Tap **Use network-provided time** to turn Off the feature.
4. Tap **Time zone** and choose the time zone for your location.

About Honeywell Applications

Honeywell applications help you troubleshoot and connect your computer to other devices and networks. Some of the applications in this table are located in the Power Tools app. To learn more about Honeywell Power Tools, go to sps.honeywell.com to download the *Power Tools User Guide*.

Honeywell Applications Available on the Computer

Icon	Application	Description
	AutoInstall Settings	Enable the AutoInstall feature, to automatically install *.zip or *.apk files containing applications saved in the Internal shared storage\honeywell\autoinstall folder and IPSM card\honeywell\autoinstall folder on the computer during the power-up boot or reboot process.
	Demos	Honeywell Demo apps demonstrate the basic capabilities of the computer and are not intended as functional business solutions. The demos included, demonstrate scanning, signature capture, NFC functionality, and printing via Bluetooth technology. Information on how to create custom applications for your Honeywell mobile computer can be found in the Honeywell Software Development Kit (SDK) for Android, available from the Technical Support Downloads Portal .
	HUpgrader	Use the HUpgrader app to view the current OTA version on the computer, check for updates, or initiate an OTA upgrade from storage.
	Scanner Edge	Use the Scanner Edge app to connect or disconnect a Bluetooth scanner. <ul style="list-style-type: none"> View connected devices. Pair with a Bluetooth Scanner. Disconnect a Bluetooth Scanner.
Power Tools		
	BattMon	BattMon provides information on the charge status and health of the battery, and provides access to activate battery status notifications and battery charging history logs.
	ConfigApps	ConfigApps enables or disables applications and application updates.
	Configure Autorun	Configure Autorun provides the ability to set applications to automatically run after a reboot.
	Diagnostic Information	Diagnostic Information provides access to system statistics, notifications and version information about the computer.

Icon	Application	Description
	EZConfig	EZConfig supports advanced customization and configuration of the handheld computer. EZConfig includes a standard XML editor and configuration barcode scanner feature.
	WiFi Diagnostic	Use application to: <ul style="list-style-type: none"> • View Wi-Fi radio status information about a connected access point or a list of other available access points in range of the Wi-Fi radio. • Use the Route utility to view packet destination gateway information across the subnets. • Use the IPConfig utility to view IP parameters for the on-board network adapters. • Use the Ping utility to verify communication links or to make sure a specific IP address is working.
	Wireless Tether	Use to enable range tracking and customize out-of-range alerts for Bluetooth devices paired and tethered to your handheld computer.

Applications You Can Download to the Mobile Computer

You can download Honeywell applications to extend the capabilities of the computer. You may need to purchase a license to run some applications. To learn more about the applications described in this section and other Honeywell software solutions, go to sps.honeywell.com and click **Software > Productivity**.

About Honeywell Enterprise Browser

Honeywell Enterprise Browser is a locked-down enterprise Web client application designed for Honeywell computers. It provides a controlled Web application environment that helps enterprises increase productivity and reduce IT management expenses. You can configure Enterprise Browser for your specific application requirements and design custom web applications that run through the Enterprise Browser to provide your users with an easy-to-use yet controlled experience.

If Enterprise Browser is not included on your computer model, you can download a trial version for evaluation. After the evaluation period expires, you need to purchase a license. For more information about Enterprise Browser, visit sps.honeywell.com.

About Honeywell Launcher

Launcher is a configurable locked-down menu program designed for Honeywell computers that prevents end-users from accessing the start menu and other non-authorized applications. Use Launcher to provide a platform where your mobile computer users are limited to running only company-approved applications and

prevent them from initiating unauthorized configuration changes. You can also use Honeywell Launcher together with Honeywell Enterprise Browser to create a single-purpose device configuration.

If Launcher is not included on your computer model, you can download a trial version of the software for evaluation. After the evaluation period expires, you need to purchase a license. For more information about Launcher, visit sps.honeywell.com.

About Terminal Emulators

Honeywell offers several terminal emulator solutions that allow users to manage their mobile devices by providing reliable data transfer between the host mobile device and terminal. Terminal emulators can be used for remote management and configuration of devices, data collection and analysis, and session management.

Depending on the computer model, a terminal emulator may come preinstalled on the device. If a terminal emulator is not included on your model, you can download a trial version for evaluation. After the evaluation period expires, you need to purchase a license. For more information, visit sps.honeywell.com.



About UEMConnect

Honeywell UEMConnect makes use of the Google OEMConfig protocol by providing standardized development for EMMs and giving access to Honeywell propriety features. EMMs making use of Google OEMConfig and Honeywell UEMConnect are enabled to provide access to Honeywell proprietary features via the EMM console.

For more information about OEMConfig, see support.google.com/work/android/answer/9388447?hl

Unlock Developer Options

Developer options only appear in the Settings app if you unlock the feature. If you are a developer working with the computer, you can easily unlock the additional settings to use for testing and debugging applications under development for the computer.

1. Swipe up from the bottom of the Home screen to access all apps.
2. Tap **Settings**  > **About phone**.
3. Tap **Build number** seven times. A message appears informing you that you are now a developer.
4. Tap **Developer options** under **Settings**  > **System** > **Advanced**.

USE THE IMAGE ENGINE

Use this chapter to understand how to scan barcodes, configure the scan settings, and capture images using the integrated image engine in the computer.

About the Image Engine

You can use the image engine in the computer as a scanner or camera.

Use the imager as a scanner to read 1D and 2D barcode symbologies, composite symbologies, and postal codes. It also supports omni-directional scanning for greater flexibility in real-world settings. By default, the scanner feature is enabled and uses the default scan profile. You can modify the Default Profile or create new profiles for custom applications from **Settings > Honeywell Settings > Scanning**.

Use the imager as a camera to capture black and white images, such as signatures or pictures of damaged inventory.

Note: *Instead of using the internal imager, you can also use Bluetooth communications to connect the computer to an external scanner, such as the Granit™ 1981i and 1911i.*

About the Scan Wedge Feature

The scan wedge feature sends scanned barcode data to an active application as Android keypad input. To scan a barcode as keyboard input, open an application that accepts text input and then scan a barcode. You can use applications that are coded to use the scanner or applications that receive data through the scan wedge feature. If an application claims the scanner through the BarcodeReader API, the scan wedge feature is temporarily disabled.

You can find information on how to create custom applications for the computer in the *Software Development Kit (SDK)* available for download from the *Technical Support Downloads Portal* at <https://hsmftp.honeywell.com>. Once you create an account and enter the portal, navigate to **Software > Software and Tools > Developer Library > SDKs for Android**.

Change the Scanner Settings

Changes you make to the Default profile apply to all applications with no profile assigned.

1. Swipe up from the bottom of the Home screen to access all apps.
2. Tap **Settings**  > **Honeywell Settings** > **Scanning**.
3. Tap **Internal Scanner** > **Default profile**.
4. Select from the following:
 - **Data Processing Settings**,
 - **Symbology Settings**,
 - **Decode Settings**,
 - **Imager Settings**,
 - **Trigger Settings**, or
 - **Notification Settings**.
5. Modify the settings to meet your application needs.

To learn more about the scanner settings, [Default Scan Settings](#) on page 47.

Restore Default Scan Settings

You can easily discard all changes you made to the Default profile and restore the default values.

Note: *When you choose the Restore all defaults option from any of the settings screens in a profile, all the settings in that profile return to their default values.*

1. Open the **Default profile**.
2. Tap  in the upper right corner of any of the scan settings screens for the profile.
3. Tap **Restore all defaults**.

Default Scan Settings

Use the following sections to understand the scan settings available for scanner profiles. To learn how to create a new profile, see page 53.

Data Processing Settings

Use the Data Processing Settings to specify how barcode data is processed by the computer.

Data Processing Settings

Setting	Description	Default										
Wedge	Enable or Disable the scan wedge feature.	Enabled										
Wedge Method	Standard or Keyboard.	Standard										
Charset	Select the character set to use when interpreting the barcode data into a string.	ISO-8859-1										
Prefix	<p>Defines the string added before the decoded barcode data. Substitutions occur within the Prefix string values.</p> <table border="1"> <thead> <tr> <th>Substring</th> <th>Replacement Character Code</th> </tr> </thead> <tbody> <tr> <td>\r</td> <td>13</td> </tr> <tr> <td>\n</td> <td>10</td> </tr> <tr> <td>\t</td> <td>9</td> </tr> <tr> <td>\\</td> <td>\"</td> </tr> </tbody> </table>	Substring	Replacement Character Code	\r	13	\n	10	\t	9	\\	\"	None
Substring	Replacement Character Code											
\r	13											
\n	10											
\t	9											
\\	\"											
Suffix	<p>Defines the string added after the decoded barcode data. Substitutions occur within the Suffix string values.</p> <table border="1"> <thead> <tr> <th>Substring</th> <th>Replacement Character Code</th> </tr> </thead> <tbody> <tr> <td>\r</td> <td>13</td> </tr> <tr> <td>\n</td> <td>10</td> </tr> <tr> <td>\t</td> <td>9</td> </tr> <tr> <td>\\</td> <td>\"</td> </tr> </tbody> </table>	Substring	Replacement Character Code	\r	13	\n	10	\t	9	\\	\"	None
Substring	Replacement Character Code											
\r	13											
\n	10											
\t	9											
\\	\"											
Wedge as Keys	List of character values to wedge as keys, represented as a comma-separated list of decimal values.	9,10,13										
Data Editing Plugin	Specify a data editing plug-in and edit plug-in settings.	None										
Symbology Prefix	<p>Specify a symbology identifier prefix to the barcode data. Options include:</p> <ul style="list-style-type: none"> • None • Honeywell • AIM 	None										

Setting	Description	Default
Launch Browser	<p>Enable or disable URL barcode handling. If a barcode starts with http:// or https://, the browser opens using the barcode data as a URL.</p> <p>Corresponds to BarcodeReader property: PROPERTY_DATA_PROCESSOR_LAUNCH-BROWSER</p>	Enable
Scan to Intent	<p>Enable or disable special handling of scan-to-intent barcodes.</p> <p>Applies to barcodes in one of the following formats: '//' ACTION '//' ACTION '\$' extra-data</p> <p>Where: ACTION and extra-data are any string of characters.</p> <p>Launches an application listening for the intent. Intent action: "com.honeywell.scantointent.intent.action." + ACTION Intent extra: "com.honeywell.scantointent.intent.extra.DATA" contains the remainder of the barcode data after the first '\$' character.</p> <p>Corresponds to BarcodeReader property: PROPERTY_DATA_PROCESSOR_SCAN_TO_INTENT</p>	Enabled
Launch EZ Config	<p>Enable or disable special handling of EZConfig barcodes.</p> <p>Applies to EZConfig barcodes that are encoded with the Aztec symbology and contain specific header data.</p> <p>Corresponds to BarcodeReader property: PROPERTY_DATA_PROCESSOR_LAUNCH_EZ_CONFIG</p>	Enabled
Data Intent	<p>Enables the reception and processing of barcode data without using an SDK or library.</p>	Disabled

Symbology Settings

Use the Symbology Settings to enable or disable barcode symbologies for the selected scan setting profile.

- Tap the check box next to a symbology name to enable (check mark) or disable (no check mark) decoding for that symbology.
- Tap the symbology name to view and modify additional configuration parameters for the symbology selected.

To view a list of default settings for supported symbologies, see [page 98](#).

Decode Settings

Adjust the Decode Settings when scanning barcodes that are densely packed or poor quality.

Decode Settings

Setting	Description	Default
Center Decode	<p>When enabled, the imager scans and decodes a barcode only if part of the barcode is at the center of the aimer window. This is useful in situations where several barcodes may be very close together in the imager field-of-view.</p> <ul style="list-style-type: none"> • Tap the check box to toggle the feature On or Off. • Select Center Decode to adjust the Center Decode Timeout and the Window dimensions. <p>Honeywell recommends leaving the settings at 50 (default) to define the “center” area for the barcode.</p> <p>Configurable parameters:</p> <ul style="list-style-type: none"> • Window top • Window bottom • Window left • Window Right 	Disabled
Decode Security	Use this setting to control the reading tolerance of the decoder. Lower settings are more lenient when reading low quality barcodes while higher values are more strict.	2
Decoder timeout	Set the amount of time in seconds that the scanner will timeout if a readable barcode is not found.	150
Decode Filter	<p>Use this setting to modify or reject data strings.</p> <ul style="list-style-type: none"> • Decode filter script The decode filter script is used to configure a filter for decode results during scanning. For example, a filter could be used to reject barcodes that don't begin with certain characters, remove leading characters (like “00”) from the beginning of a barcode, or only scan barcodes that begin with certain characters. • Decode filter timeout (ms) The decode filter timeout option can be used to disable the logic inside the filter script after a given amount of time. • Debug level Set the filter information level. The default level is 0, no information. Higher levels emit more information. Level 4 emits the most information. 	None
Poor Quality 1D Reading	Enable this setting when scanning damaged or badly printed 1-D barcodes to improve barcode read success.	Disabled
Video mode	<p>Use this setting to specify whether normal or inverse decoding for linear symbologies is enabled during the execution of Decode. By default normal video is enabled.</p> <p>Options include:</p> <ul style="list-style-type: none"> • Normal • Inverse • Normal and Inverse 	Normal

Setting	Description	Default
DPM mode	<p>Use this setting when scanning Direct Part Marking (DPM) barcodes that are etched or imprinted directly into the surfaces of materials including metal and plastic.</p> <p>Options include:</p> <ul style="list-style-type: none"> • No DPM optimization • Dotpeen DPM decoding • Reflective DPM decoding 	No DPM optimization
Region of Interest	<p>Set the ROI for decoding. Options include:</p> <ul style="list-style-type: none"> • Disable ROI is disabled and the entire original image is sent to the decoder. • Standard Use the aimer position to weight activity. Activity calculated on the row and the column in the middle of each cell. The ROI window may not include the aimer. • Standard, aimer centered Activity calculated on the row and the column in the middle of each cell. The ROI window will always include the aimer. • DPM, aimer centered Activity calculated on 4 rows and 2 columns in each cell. The ROI window will always include the aimer. • Kiosk/presentation application Ignore aimer position, no weight activity. Activity calculated on the row and the column in the middle of each cell. The ROI window may not include the aimer. • Learning Engine When selected, the computer will receive continuous updates to improve the decoder software based on your specific environment. The Staging Hub Agent must also be enabled. 	Disabled

Setting	Description	Default
Multicode Scan	<p>When you enable Multicode Scan, each barcode is checked to see whether it satisfies the defined multicode rules before the results are transmitted. Options include:</p> <ul style="list-style-type: none"> • Enable or disable multicode scanning. • Set the number of barcodes. • Specify a separator to be used between barcodes. • Define up to 10 barcodes to be included in the multicode. • Set a timeout in milliseconds. If set with a non-zero value, the timeout starts after the scan button is pressed. Once the timeout occurs, scanning will return to standard (single) barcode mode. • Enable or disable the transmission of an incomplete multicode. When enabled, the incomplete multicode is transmitted when the incomplete transmission timeout expires. • Set a timeout in milliseconds to use when incomplete transmission is enabled. If set with a non-zero value, the timeout starts after the scan button is pressed. Once the timeout occurs, the results that were collected before the timeout happened will be transmitted if they satisfy the defined multicode rules. 	
Preferred Symbology Settings	<p>Set the priority level (High or Low) for symbology codes. This is used when you want to specify one symbology as a higher priority over other symbologies in situations where both bar code symbologies appear on the same label, but the lower priority symbology cannot be disabled. If a code is set as a High Priority, the decode of that symbology is accepted immediately. If a code is set as a Low Priority, the decode is buffered to see if a decode of a preferred High Priority symbology can be found within a given timeout period.</p> <p>To apply Preferred Symbology Settings, tap the check box. Preferred Timeout (ms) - The amount of time milliseconds that will allow the scanner to search for a High Priority bar code after a Low Priority bar code has been encountered. The default is 500ms.</p> <p>To set the priority level for a symbology, tap the code in the list then select the priority. The default for all codes is "High Priority."</p>	Disabled

Imager Settings

You should not need to modify the Imager Settings. The **Override Recommended Values** setting is disabled by default. The recommended Imager Settings are designed to work in a wide range of environments and should only be modified if you have an advanced understanding of imagers.

Trigger Settings

Use the Trigger Settings to configure how the scan buttons work.

Trigger Settings

Setting	Description	Default
Enable Scan Trigger	Enable or Disable activating the imager by pressing the side scan buttons or the virtual Scan button in the Scan Demo app.	Enabled
Scan delay	Set the minimum amount of time in seconds before the scanner can read another barcode.	0
Decode timeout	Set the number of seconds before the scanner automatically turns off if the scan button is pressed and nothing has successfully decoded.	20
Trigger Scan Mode	Set read behavior on scan button press. Options available: <ul style="list-style-type: none"> • One Shot • Continuous • Read on release • Read on second trigger press 	One Shot
Same symbol timeout	Set the minimum buffer time in seconds before the scanner reads the same barcode. This can be adjusted to prevent inadvertent scans of the same barcode if the code is left in the scan field longer than the Decode Timeout limit. The default same symbol timeout is 1000 seconds.	Disabled

Notification Settings

Use the Notification Settings to configure how your computer responds when you scan a barcode.



Notification Settings

Setting	Description	Default
Good Read Notification	Enables or disables a good read notification. The notification consists of a green blink of the Scan Status LED, a short beep, and an optional short vibration.	Enabled
Bad Read Notification	Enables or disables notification of a failed scan. The notification consists of a red blink of the Scan Status LED, an error beep, and an optional short vibration.	Disabled
Vibrate On Notification	Enables or disables whether the computer vibrates when there is a good or bad read.	Disabled
Package Verification	Package verification automatically stores the package images from the near sensor to determine the context in which the barcode was read. This data can be used as proof of delivery and can be uploaded to Honeywell or customer cloud using SSClient or customer-specific software. Select the check box to turn the Package Verification setting on.	Disabled
Package Verification Max Folder Size (MB)	The maximum folder size allowed for the folder that stores Package Verification images. Images are stored in honeywell\ImageCapture\PackVerf_Images.	200 MB

Setting	Description	Default
Pkg Verify High Quality Image Save	Enable this option to add new images and delete old images when the maximum folder size is reached. If this is not enabled, new images will not be stored until files are removed by the user.	Disabled

Add a Scan Setting Profile

To create a scan setting profile for a custom app on the computer:

1. Swipe up from the bottom of the Home screen to access all apps.
2. Tap **Settings**  > **Honeywell Settings** > **Scanning** > **Internal Scanner**.
3. Tap  in the upper right corner of the app screen.
4. Take one of the following actions:
 - Tap the profile name field. Add a new name, and then select **OK**.

OR

 - Tap the **select an application** option, and then choose an app from the list.

The new profile appears on the Internal Scanner profile list. You can now select and modify the scan settings for the new profile.

Delete a Scan Setting Profile

1. Swipe up from the bottom of the Home screen to access all apps.
2. Tap **Settings**  > **Honeywell Settings** > **Scanning** > **Internal Scanner**.
3. Tap and hold the profile you want to delete.
4. Tap **Delete**, and then **OK**.

Change the Bluetooth Scanner Settings

When a Bluetooth scanner is paired, changes can be made to the Default profile for the scanner.

1. Swipe up from the bottom of the Home screen to access all apps.
2. Tap **Settings**  > **Honeywell Settings** > **Scanning**.
3. Tap **Bluetooth Scanner** > **Default Profile** > **Data Processing Settings**.
4. Modify the settings to meet your application needs.

To learn more about the scanner settings, see [Data Processing Settings](#) on page 47.

About the Optional Digital Scan Button

By default, the imager is enabled for scanning with the left, right, and front scan buttons configured to trigger the imager. If your application environment requires use of an on-screen scan button, enable the Digital Scan Button feature in the Settings app. Once enabled, you can then modify the appearance of the on-screen Scan button and select the apps the button appears in.

Enable and Configure the Digital Scan Button

1. Swipe up from the bottom of the Home screen to access all apps.
2. Tap **Settings**  > **Honeywell Settings** > **Digital Scan Button**.
3. Tap **Enable Digital Scan Button** to turn the feature on. A preview of the button appears at the bottom of the screen.
4. Configure the button appearance. As you adjust the settings, the preview button updates.
 - Tap **Select Button Size**, and then choose Small, Medium or Large.
 - Tap **Select Button Color** and then choose from seven color options. Default color is black. Tap a dot to select the color, and then select **OK** to confirm.
 - Use the slider under **Transparency Level** to adjust how transparent the button appears on the application screen.
5. Drag the preview of the scan button to the location where you want it to appear on the screen. Once you have positioned the button, select the **Set Button Location** toggle button to lock it into position.
6. Tap **Choose Application**.
7. Check the box next to all the applications where you want the digital scan button to be available.
8. Select **OK**.
9. Tap **Back** to return to the Settings screen.

The digital scan button appears on the screen when you open any of the apps you selected during the button setup. Tap and hold the button to activate the imager and scan a barcode.

Scan Barcodes

By default, the computer imager is enabled for scanning. It supports omni-directional (360°) barcode scanning and an aiming beam is provided to help assist with targeting barcodes.

Before you start scanning barcodes, go into **Settings > Honeywell Settings > Scanning > Internal Scanner** and modify the scan profile to enable only the barcode symbologies that you need. By reducing the active symbology list, you can increase scan speed.

1. Point the scanner window at the barcode. For optimum performance, avoid reflections by scanning the barcode at a slight angle.
2. Press and hold any **Scan** button (i.e., right, left, or front).
3. Center the aiming beam over the barcode. Make sure the entire barcode is inside the illumination frame.

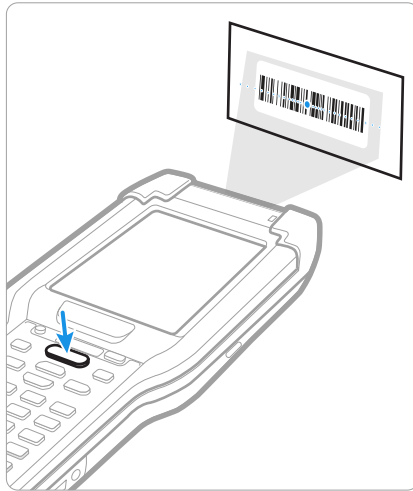

4. Release the Scan button when the computer beeps, and the Scan Status LED briefly turns on. The barcode information is entered into the application in use.

Note: *Not all barcode symbologies are enabled by default. If a barcode does not scan, the correct symbology may not be enabled.*

About Scanning Configuration Barcodes

After completing the out-of-box set up process, Provisioning mode is automatically turned Off. Scanning a barcode to install applications, certificates, configuration files, and licenses on the computer is restricted unless you turn On (enable) Provisioning mode in the Settings app.

To learn more [About Provisioning Mode](#) see [page 81](#).

Use the Scan Demo App

Use the Scan Demo app to read barcodes or to test your symbology decode settings.

1. Swipe up from the bottom of the Home screen to access all apps.
2. Tap the **Demos** app.

3. Swipe left or right on the screen until **Scan Demo** appears under the turntable. Tap the center of the box image to open the app.
4. Point the scanner window at the barcode.
5. Press and hold any **Scan** button (i.e., right, left, or front) or tap and hold the on-screen **Scan** button.
6. Center the aiming beam over the barcode. Make sure the entire barcode is inside the illumination frame.

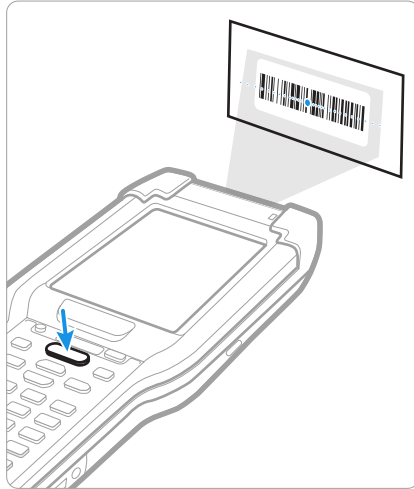

7. Release the Scan button when the computer beeps, and the Scan Status LED briefly turns On. barcode information appears on the screen.

Note: *In the Scan Demo app, not all barcode symbologies are enabled by default. If a barcode does not scan, the correct symbology may not be enabled.*

Change the Scan Demo Symbology Settings

1. In the Scan Demo app, tap **⋮** in the upper right corner of the screen.
2. Select **Symbology Settings**.
3. Modify the symbology parameters.
 - Tap the check box next to a symbology name to enable (check mark) or disable (no check mark) decoding for that symbology.
 - Tap the symbology name to view and modify additional configuration parameters for the symbology selected.
4. Tap **Back** to return to the Scan Demo app.

USE THE CAMERA

Use this chapter to learn how to take pictures and record videos with the color camera.

Note: *The camera feature is not available for cold storage CK65 models.*

About the Color Camera

The CK65 comes equipped with a 13-megapixel color camera, 4K video with image stabilization, and advanced software features for enhanced exposure control for taking pictures and videos. The camera lens and flash are located on the back of the computer.

Use the Photos app  to view photos and videos stored on the CK65.

By default the photos and videos captured with the Camera app are saved on the computer under Internal shared storage\DCIM\Camera.

How to Zoom

The camera zoom is controlled using a pinching motion on the touch screen. Place two fingers on the screen at the same time, and then:

- spread them apart to zoom in (enlarge and object).
- pinch them together to zoom out.

Take a Photo

1. Tap the **Snapdragon™ Camera** icon  in the favorites tray on the Home screen.
2. Using the screen as a viewfinder, move the computer until you see the image you want to capture. The camera lens is located on the back of the computer.

3. The camera automatically adjusts the focus but you can tap the screen to modify the focal point. By default, the camera senses the lighting in the environment and turns the flash on, if needed.
4. Tap  to take a photo.
 - To view the picture, tap the preview near the bottom of the screen.
 - To return to the Camera app, tap the **Back** navigation button.

Change Camera Settings

You can change the camera settings for best results when taking pictures. The camera settings are adjustable from within the Snapdragon™ Camera app.



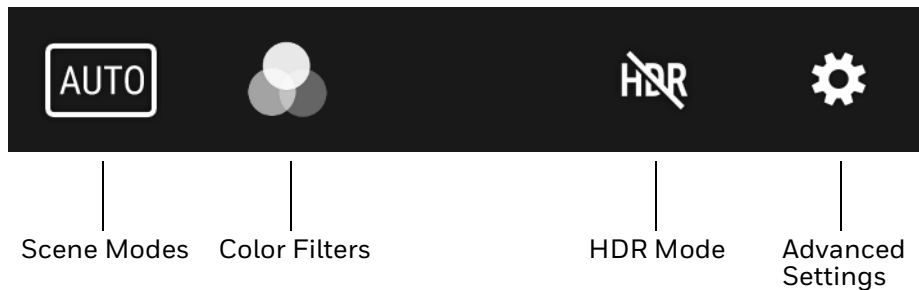

1. Open the **Snapdragon Camera** app .
2. At the top of the screen, select any of the following to adjust the settings.



- **Scene Modes**
Use preset setting profiles for best picture quality. Options include: Automatic, High Dynamic Range (HDR), Portrait, Landscape, Sports, Flowers, Backlight, Candlelight, Sunset, Night, Beach, and Snow.
- **Color Filters**
Stylize your pictures by applying a filter. Options include: None, Mono, Sepia, Negative, Solarize, Posterize, Aqua, Emboss, Sketch, and Neon.
- **HDR Mode**
Tap to quickly toggle HDR mode On or Off. When enabled, the computer automatically captures multiple photos and combines them into one photo creating the best quality image possible.
- **Advanced Settings**
Manually set advanced features. Options include: Flash, GPS location, Picture size, Picture quality, Countdown timer, Storage, Continuous shot, Face detection, ISO, Exposure, White balance, Redeye reduction, and Shutter sound.



Record a Video

This section explains how to record video with the camera in the computer.

1. Tap the **Snapdragon Camera** icon  in the favorites tray.
2. Tap mode selection  in the bottom right corner of the app.
3. Tap  to select video.
4. Tap  to begin recording video. To zoom in or out, pinch or spread your fingers apart.
5. When you are done recording, tap .

Change Video Settings

You can change the video settings for best results when recording video.

1. Open the **Snapdragon Camera** app .
2. Tap  to select video.
3. At the top of the screen, select any of the following to adjust the settings.

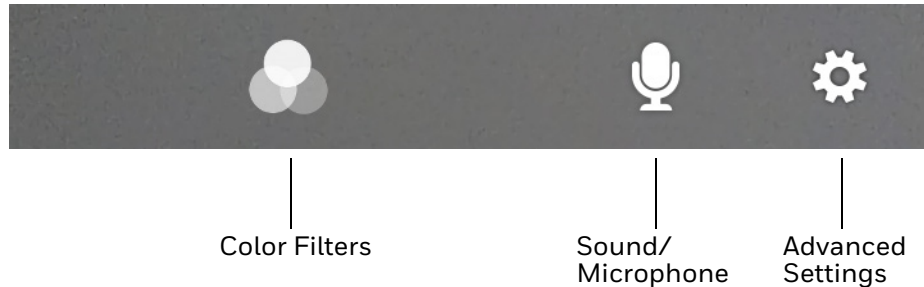

- **Color Filter**
Stylize your video by applying a filter. Options include: None, Mono, Sepia, Negative, Solarize, Posterize, Aqua, Emboss, Sketch, Neon.
- **Sound/Microphone**
Tap to quickly toggle sound recording On or Off.
- **Advanced Settings**
Manually set advanced features. Options include: Flash, Video quality, Video duration, GPS location, Storage, White balance, Video High FrameRate, and Image stabilization.

Use the Camera as a Flashlight

To use the camera as a flashlight.

1. Open Quick Settings (see page [39](#)).
2. Tap the **Flashlight** icon to turn the flashlight on.
 - Select the icon again to turn the flashlight off.

CONFIGURE THE COMPUTER

Use this chapter to learn about the available methods for configuring your mobile computer. You can also use this chapter to learn how to configure network communications and wireless security.

How to Configure the Computer

You can configure many parameters on the computer such as the bar code symbologies the integrated scanner decodes, or the network settings. The values you set for these parameters determine how the computer operates.

You configure the computer using the Settings app. Or you can use Wi-Fi Staging to set up multiple devices with the same base configuration (see page 82).

Start the Settings App

The Settings app is available from the all apps menu and the notification panel.

- Swipe up from the bottom of the Home screen to access all apps, and then tap **Settings** .

OR

- Swipe down from the top of the Home screen, and then select  in the status bar.

About the Structure of the Settings App

Use this section to learn about the structure of the Settings app so you can find parameters quickly. A search field appears at the top of the screen when you open the Settings app to help you locate settings quickly.

Note: *The Settings app varies by computer model and OS version. Your computer may not include all the features outlined in this section*

Network & Internet

In the Settings app, select **Network & Internet** to access the following settings.

Setting	Description
Wi-Fi	<ul style="list-style-type: none">• Turn WLAN radio On or Off.• Lists available Wi-Fi networks in range and the connection status when the radio is turned On.• Add a network Wi-Fi connection.• Set Wi-Fi preferences and advanced settings.
Airplane mode	Turn Airplane mode On or Off.
Ethernet	<ul style="list-style-type: none">• Turn Ethernet connection On and Off.• Configure Ethernet connections and set up proxy settings when the Ethernet setting is turned On.
Data Saver	Turn the Data saver feature On or Off. Specify which apps can use unrestricted data.
VPN	Set the password parameters for a virtual private network (VPN) connection.
Advanced	
Private DNS	Select Private DNS Mode.

Connected devices

In the Settings app, select **Connected devices** to access the following settings.

Setting	Description
Pair new device	<ul style="list-style-type: none">• Connect a Bluetooth Device.• Lists Bluetooth-enabled devices in range.• View and rename the computer.• View the computer Bluetooth address.
Previously connected devices	View previously connected devices.
Connection preferences	
Bluetooth	<ul style="list-style-type: none">• Turn the Bluetooth radio On or Off.• Lists Bluetooth enabled devices in range when the radio is turned On.• Connect to a Bluetooth Device.• View and rename the computer.• View the computer Bluetooth address.• View received files.
NFC	Turn Near Field Communication (NFC) On or Off. When the NFC radio is enabled, data exchanges are allowed when the computer touches another NFC enabled device.
Cast	Set up a Cast connection. Cast (project) audio and screen content to a secondary device such as a television.

Setting	Description
Android Beam	Turn the Android Beam feature On or Off. When NFC is enabled, this feature is accessible. You can beam app content to another NFC capable device by holding the devices close together. The app determines what content is transmitted to the other device.
Printing	Set up a printer connection with the CK65. Connection options include cloud print services, Wi-Fi printing via a router or printing via NFC.
Files received via Bluetooth	View statistics and received files.
Chromebook	Connect the CK65 to a Chromebook.
Nearby Share	Share files with nearby devices.
Android Auto	Use apps on your phone screen or car display. To learn more go to Android Auto Help at https://support.google.com .

Apps & Notifications

In the Settings app, select **Apps & Notifications** to access the following settings.

Setting	Description
App info	View a list of all apps installed on the computer and system services running.
Conversations	View conversations marked as a priority.
Notifications	Set rules for notifications.
Screen time	<ul style="list-style-type: none"> Show screen time, notifications received, times opened. Set app timer.
Advanced	
Default apps	View and manage default app use.
Permission manager	View and manage individual app permissions.
Special app access	Manage apps with special unrestricted access.

Battery

In the Settings app, select **Battery** to view battery status, use statistics and adjust features that conserve battery charge.

Note: Some settings in previous OS versions can be found in Display.

Setting	Description
Battery	View current battery charge or charging status.
Battery Saver	Turn the Battery saver feature On or Off manually. Set a schedule based on the battery charge percentage (%) remaining that automatically activates the Battery saver feature. Use the slider to set the battery percentage level. Slider adjusts from 5% to 7% and is only available once schedule is selected. When charging, set the battery saver feature to turn Off when the battery reaches 90%. Default setting.
Battery Manager	Turn the Battery Manager On or Off. Battery Manager detects when apps drain the battery.

Setting	Description
Battery percentage	Set to show or do not show battery percentage in status bar.
Last full charge	View time since the battery was fully charged.
Screen usage since last full charge	View amount of time when the screen was used since the battery was fully charged.

Display

In the Settings app, select **Display** to access the following settings.

Setting	Description
Brightness level	Set the Brightness level manually if Adaptive brightness feature is turned Off.
Dark theme	Enable dark mode to switch app backgrounds to a black color.
Night Light	Activate the Night light feature to adjust the screen tint to a light amber for easier viewing and reading in dim light or for the hours you use the device before going to sleep. Set the feature to stay on or define a schedule to automatically turn the feature On/Off. You can manually adjust the intensity of the amber hue once the feature is activated.
Adaptive brightness	Set how the screen in sleep mode responds when new notifications are received (e.g., wake or do not wake).
Wallpaper	Set the wallpaper.
Advanced	
Screen timeout	Set the inactivity time limit before the unit automatically turns of the screen to save battery power (seconds or minutes).
Keypad backlight	Enable the keypad backlight. Set the inactivity time limit before the unit automatically turns off the keypad backlight to save battery power (seconds or minutes).
Auto-rotate screen	Set the screen to switch from portrait to landscape when the unit is rotated. When Off the screen does not automatically rotate.
Font size	Set the default on-screen text size.
Display size	Set the default size of items on your screen.
Screen saver	Set the default screen saver as well as when to display it.
Lock screen	Select what to show on the lock screen and when to display new notifications.

Sound

In the Settings app, select **Sound** to modify the audio and sound settings. To learn more, see [Audio Settings](#) on page 24.

Storage

In the Settings app, select Storage to view statistics on available and used storage space on the device and on any portable storage cards installed.

Privacy

In the Settings app, select **Privacy** to define privacy settings for the device.

Setting	Description
Permission manager	View and manage individual app permissions.
Show passwords	Enable or disable showing characters briefly as you type.
Notifications on lock screen	Enable or disable notifications on the lock screen.
Autofill service from Google	Automatically fill fields using saved data from your Google account.
Advanced	
Google location history	Enable or disable location history and manage or delete activity. A Google account must be associated with the device to use this feature.
Activity controls	Choose what type of activities are saved in your Google account. A Google account must be associated with the device to use this feature.
Ads	Opt in or out of ad personalization features. When this feature is on, ads are personalized with the activity and information from your Google account.
Usage & diagnostics	Automatically send diagnostic, device, and app usage data to Google. A Google account must be associated with the device to use this feature.

Location

In the Settings app, select **Location** to define which apps have access to the device's location.

Setting	Description
Use location	Turn location services (Google and GPS satellite data) On or Off. Set location mode accuracy and view location request history.
App access to location	View and manage app-level location service permissions.
Wi-Fi and Bluetooth scanning	Turn Wi-Fi and/or Bluetooth scanning On or Off. When enabled system apps and services are allowed to detect Wi-Fi networks or Bluetooth devices at any time to improve location services.
Advanced	
Emergency Location Service	Allows the device to automatically send its location to emergency locations.
Google Location Accuracy	Improves location accuracy by using Wi-Fi, mobile networks, and sensors to help estimate the device's location.
Google Location History	Allows the device to report location history to Google. A Google account must be associated with the device to use this feature.

Security

In the Settings app, select **Security** to view latest Security scan results, security updates and phone encryption status. Access additional settings related to device security.

Setting	Description
Google Play Protect	Manually initiate a scan of the apps on the device to check for problems.
Security update	Displays the last date security was updated on the device.
Find My Device	Allows users to locate, ring, or wipe a device remotely.
Screen Lock	Activate and configure a screen lock (i.e., None, Swipe, Pattern, Pin, Password).
Smart Lock	Define safe conditions or locations where your phone will stay unlocked (e.g. On-body, Trusted places, Trusted devices, Voice Match).
Device admin apps	Manage administrator privileges.
Encryption & credentials	View encryption status and manage trusted credentials (e.g., view, install, clear, and edit).
Trust agents	View and enable/disable trusted agent apps such as, Smart Lock by Google on the device. Trusted agents bypass security based on set parameters.
App pinning	Enable or disable the app pinning feature. When enabled you can pin the device screen to a recently used app where it stays until you unpin the app via the security method chosen.

Accounts

In the Settings app, select **Accounts** to access the following settings.

Note: Some settings in previous OS versions can be found in System.

Setting	Description
Add account	Select to add and manage Corporate or Email account on the computer.
Automatically sync data	Turn auto-sync On or Off for accounts. Turning the feature On allows apps to refresh data automatically.

Accessibility

In the Settings app, select **Accessibility** to access screen readers, display settings, interaction controls, and audio & on-screen text features to improve accessibility levels.

Setting	Description
Touch Gesture	Select to use the Touch Gesture service to allow multi-touch gestures.
Select to Speak	When turned on, you can tap specific items on the screen to hear them read aloud.

Setting	Description
TalkBack	When turned on, the feature provides spoken feedback so you can use the computer without always looking at the screen. TalkBack describes your actions and tells you about alerts and notifications
Text-to-speech output (TTS)	Select and configure the preferred TTS engine, set language, speech rate and pitch of synthesized voice.
Display	Configure display features that may aid visual accessibility levels. <ul style="list-style-type: none"> • Adjust Font size • Display size • Turn Dark theme On/Off • Turn the Magnification feature On/Off • Set Color correction • Turn Color inversion On/Off • Turn Large mouse pointer On/Off • Turn Remove Animations On/Off
Interaction controls	Set interaction controls that may aid physical accessibility levels. <ul style="list-style-type: none"> • Accessibility Menu provides large on-screen menus • Configure Switch Access • Set the Dwell timing (click after pointer stops moving) delay • Turn the Power button ends call feature On/Off • Turn Auto-rotate screen On/Off • Adjust the Touch & hold delay • Time to take action (Accessibility timeout) • Vibration & haptic strength • Set System navigation (e.g., Gesture navigation or 3-button navigation)
Audio & on-screen text	<ul style="list-style-type: none"> • Turn Mono audio On/Off • Adjust volume balance if using headphones or hearing aids • Turn Captions On/Off
Experimental	<ul style="list-style-type: none"> • Turn High contrast text On/Off. • Turn Shortcut from lock screen On/Off.

Honeywell Settings

In the Settings app, select **Honeywell Settings** to access the following settings.

Setting	Description
Battery LED	Configures the battery LED behavior. To learn more see, Change the Battery Status LED Behavior on page 10.

Setting	Description
Battery Optimizer	<p>View battery status and app usage information. Create and enable or disable a battery optimization profile that implements a group of settings to conserve power.</p> <p>Options include:</p> <ul style="list-style-type: none"> • None When selected, no battery optimization profile is active. • Energy Saver This pre-defined profile implements UI settings that optimize battery conservation. • Cold Storage This pre-defined profile implements UI settings that optimize battery conservation in cold storage environments. • Custom Profile Tap to create a custom battery profile that balances your application needs with energy saving settings. You can turn location services On or Off, configure sound and vibration options, modify brightness and timeout display options, turn UI transition animations On or Off and background services On or Off.
Digital Scan Button	<p>Enable and configure the optional digital scan button. To learn more, see About the Optional Digital Scan Button on page 54.</p>
Heater	<p>Set the heater parameters on cold storage models. See About Cold Storage Heaters on page 25.</p>
Honeywell Power Setting	<p>Turn Unattended Mode on or off. When Unattended Mode is on, healthcare apps will continue to notify clinicians of critical communication, even though the unit appears to be in sleep mode.</p>
HXLogger	<p>The HXLogger is an advanced diagnostic log service that provides a basic log service, plug-ins for modified log services, and a log manager.</p> <ul style="list-style-type: none"> • Tap HXLogger to turn the basic log service On or Off. When enabled the service records app and system diagnostic troubleshooting information into four basic log files: main log file, radio log, event log, and kernel log. • Tap Plugin to view and enable additional log services and custom plug-ins. • Tap Manager, to change the default log path, delete logs or upload logs for technical support troubleshooting.
Key WakeUp	<p>Set the buttons you want to use to wake the computer from sleep mode. Options include: Left Scan, Middle Scan, Right Scan. By default the Left, Middle and Right Scan buttons are enabled for wake up.</p>
Keyremap	<p>Change (remap) a button or key function. To learn more, see Remap a Button or Key on page 37.</p>
Provisioning Mode	<p>Enable or disable unrestricted installation of applications, certificates, configuration files, and licenses. Provisioning mode is turned Off by default. To learn more About Provisioning Mode, see page 81.</p>
Scanning	<p>Configure the computer imager. To learn more, see Change the Scanner Settings on page 46.</p>
Smart Sensor	<p>Configures the integrated motion detection sensors for advanced power management. Options include: Keep awake on motion, Wake on motion, Face down suspend.</p>

Setting	Description
Staging Hub Agent	Use this agent and settings to connect the computer to the Honeywell Staging Hub Foundation software platform; a centralized software platform IT integrators and administrators can use as a solution for managing, monitoring and deploying Honeywell devices in a connected workspace environment.
Sticky Option	Choose whether modifier keys are “sticky” (remain active). The default is Off. To learn more about modifier keys see page 17.
Touch Screen Profile	Optimize screen interactions by selecting a touch screen profile designed specifically for your use case. To learn more, see page 14.
Voice Wedge	Voice-to-text conversion tool that can be triggered by a specified start word or key press event. Voice Wedge can be configured to take effect globally or only for an associated application.
Web Applications	Enable access for Honeywell Mobility SDK for Web apps and port selection.
Wi-Fi Staging	Use the Honeywell Wi-Fi Staging app to quickly set up new devices by configuring one device and using it to stage others. Wi-Fi Staging can also be used to enroll devices in a Mobile Device Management (MDM) system by connecting units to a specified network and downloading and installing the specified MDM client app. To learn more, see page 82.

Digital Wellbeing

In the Settings app, select Digital Wellbeing. See <https://wellbeing.google> for more information.

Google

In the Settings app, select **Google** to set up and manage your Google accounts and services.

System

In the Settings app, select **System** to access the following settings.

Setting	Description
Language & input	<ul style="list-style-type: none"> Set the active language. Set and manage Virtual and Physical Keyboard input methods. Configure auto-typing features such as capitalization, punctuation, spell check, and the personal dictionary. Adjusts the pointer speed. Set text-to-speech output.
Gestures	<ul style="list-style-type: none"> Turn Jump to Camera On/Off. Set system navigation preferences. Set the Prevent ringing option. Options: Vibrate, Mute, Do Nothing.
Date & time	Configure all date and time settings.

Setting	Description
Backup	Turn the Google Drive backup feature On or Off. When enabled, phone data (e.g., apps, apps data, call history, contacts, device settings, SMS, Wi-Fi passwords and permissions) is automatically backed up to the Google Drive.
Advanced	
Reset options	Select from the following reset options: <ul style="list-style-type: none"> Reset Wi-Fi, Mobile & Bluetooth Use to reset all network settings, including Wi-Fi, Mobile data and Bluetooth. Reset app preferences. Use reset app preference back to defaults. This apps you disabled, notification changes, default app actions set, background data restrictions for apps and permission restrictions. Enterprise data reset. To learn more, see Enterprise Data Reset the Computer on page 92. Erase all data (factory reset). To learn more, see Erase All Data (Factory Reset) on page 93.
Multiple users	<ul style="list-style-type: none"> Modify the owner profile name and add profiles for other people who use the computer. Activate a different user profile. Enable or disable allowing users to be added from the lock screen.
Developer options	Enable developer-specific options such as USB debugging and SD card protection. This option only appears under System settings if you enable the feature. To learn more, see Unlock Developer Options on page 44.

About Phone

In the Settings app, select **About Phone** to access the following information.

Setting	Description
Device name	A nickname to identify the device. To change, tap Device name and enter a new name.
Phone number	The phone number(s) assigned to the device.
Emergency information	Emergency medical and contact information that will be displayed on the lock screen in an emergency.
Legal information	Provides links to third-party licenses and other legal information.
Compliance information	Displays certification and compliance information.
Compliance Logo	Displays regional compliance marks.
Model	Displays the model number, serial number, and hardware version of the device.
Android version	The version of Android on the device. Tap to view additional details.
Asset number	Asset tag assigned to the device.
IP address	IP address associated with the device.
Wi-Fi MAC address	Wi-Fi Mac address associated with the device.

Setting	Description
Bluetooth address	Bluetooth address associated with the device.
Software component version	Select to view software component version list.
Build number	Kernel number installed.

About Network Communications



You can easily add the mobile computer to your wireless or wired data collection network. Connect the CK65 your computer using:

- 802.11 a/b/g/n/ac radio communications.
- Ethernet communications.
- Bluetooth communications.
- USB and serial communications.

Connect to a Wi-Fi Network

The computer contains an 802.11 a/b/g/n/ac radio to transfer data using wireless communications. Before you connect to a Wi-Fi network, you need to know about your network security protocol and its required credentials.

By default, the 802.11 radio is disabled.

1. Swipe up from the bottom of the Home screen to access all apps.
2. Tap **Settings**  > **Network & internet** > **Wi-Fi**.
3. Tap **Off**  to toggle Wi-Fi radio **On** . A list of discovered networks appears.
4. On the list, tap a network name to initiate a connection.

To add a network if it does not appear on the list:

- a. Navigate to the end of the discovered network list, and then tap **Add network**.
 - b. Type the Wi-Fi network name (SSID).
 - c. Choose a security protocol and add any required information.
 - d. Tap **Save**.
5. Enter any required information if the network is secured (e.g., password, key or certificate name).
 6. Tap **Connect**.



Once you connect to a saved Wi-Fi network:

- Tap the network name on the list to view details (e.g., status, signal strength, speed, frequency, security type). Select  to close details screen.
- The computer automatically connects to the same network when the network is in range and the WLAN radio is turned On.
- To remove a network from your saved list, tap and hold the network name and select **Forget network**. You can do this for networks you no longer use.
- To modify a network from your saved list, tap and hold the network name and select **Modify network**. You can do this if you changed your network password.
- To view a list of only your saved networks, navigate to the bottom of the discovered network list. Tap **Saved networks**.

Configure Proxy Settings for a Wi-Fi Network

If you need to connect to network resources through a proxy server, you can configure settings for the proxy server for each Wi-Fi network you add. By default, the Wi-Fi networks you add are not configured to connect through a proxy server.

Note: *Proxy settings apply only to the Wi-Fi network you modify. You must change proxy settings for each network requiring a proxy server.*

1. Swipe up from the bottom of the Home screen to access all apps.
2. Tap **Settings**  > **Network & internet** > **Wi-Fi**. The list of available Wi-Fi networks appears.
3. Tap the Settings icon .
4. Tap the Edit icon .
5. Tap **Advanced options**.
6. Under **Proxy**, select **Manual**.
7. Enter the proxy settings for the network.
8. Tap **Save**.

Disable Wi-Fi Notifications

By default, when Wi-Fi is enabled, you receive notifications in the Status bar when the computer discovers a wireless network. You can disable these notifications.

1. Swipe up from the bottom of the Home screen to access all apps.
2. Tap Settings  > **Network & internet** > **Wi-Fi**. Verify the WLAN radio is turned On.
3. Navigate to the bottom of the discovered network list.
4. Select **Wi-Fi preferences**.

5. Tap **Notify for public networks** to toggle the setting On or Off.

Connect to an Ethernet Network

To connect the computer to an Ethernet network, you need a CK65 Ethernet Home Base or a CK65 Net Base.

1. Make sure the base is connected to your Ethernet network.
2. Place the computer in the base.
3. Swipe up from the bottom of the Home screen to access all apps.
4. Tap **Settings**  > **Network & internet** > **Ethernet**. The Ethernet setting is turned On by default.
5. Tap **Ethernet**.

The Ethernet connection screen shows the current Ethernet connection. By default, the computer assumes a DHCP connection, and that your network has assigned an IP address automatically. If DHCP is working, the Ethernet base should indicate that communication with the network is occurring.

6. (Optional) To assign a static IP address.
 - a. Tap **DHCP** and then select **Static** from the list.
 - b. Enter the required network information, and then tap **Apply**.
7. Tap **Save**.

How to Connect to Virtual Private Networks

The computer supports connecting to virtual private networks (VPNs). This section describes how to add and connect to VPNs. To configure VPN access, you must obtain details from your network administrator. You can view and change VPN settings in the Settings app.

Note: Before you can add or connect to a VPN network, you must enable a screen lock method.

Add a VPN



Before you can connect to a VPN, you must create a VPN profile.

1. Swipe up from the bottom of the Home screen to access all apps.
2. Tap **Settings**  > **Network & internet** > **VPN**.
3. Tap **+** to add a VPN new profile.
4. Enter the required information for the VPN connection. If needed, swipe up on the screen to access all the required information fields.

5. Tap **Save**. The VPN name appears in the VPN list.

Connect to a VPN



Once a VPN profile is created, you can connect to the VPN at any time.

1. Swipe up from the bottom of the Home screen to access all apps.
2. Tap **Settings**  > **Network & internet** > **VPN**.
3. Type the name of the VPN in the list.
4. Enter any necessary credentials when prompted.
5. Tap **Connect**. A  appears in the status bar and a notification is received.

To disconnect from the VPN, tap the notification.

Edit VPN Information

Editing an existing VPN profile can be done from the VPN screen.

1. Swipe up from the bottom of the Home screen to access all apps.
2. Tap **Settings**  > **Network & Internet** > **VPN**.
3. Tap and hold the name of the VPN in the list.
4. Tap  to the right of the VPN profile you want to edit.
5. Edit the VPN settings as necessary.
6. When you are done, tap **Save**.

About Wireless Security

The computer provides these security solutions for your wireless network:

- Wi-Fi Protected Access 2 (WPA2™)
- Wi-Fi Protected Access (WPA)
- 802.1x

Honeywell recommends WPA2 security with PSK (Personal) or 802.1x (Enterprise) key management.

Before you set security, you need to enable the radio, set the date, and set the SSID on your computer. To use 802.1x security, you need to load a root certificate on your computer. To use transport layer security (TLS) with 802.1x security, you also need to load a user certificate.

Use the Settings app to access and configure all wireless security settings.

About Certificates

You can use digital certificates to identify the computer for network access or authentication to servers. To use a certificate to identify your device, you must install it in the trusted credential storage on the computer.



Android supports DER-encoded X.509 certificates saved in files with a .crt or .cer file extension. To install a valid certificate with a .der or other extension, you must change the extension to .crt or .cer to install it.

Android also supports X.509 certificates saved in PKCS#12 key store files with a .p12 or .pfx extension. To install a valid key store file with another extension, you must change the extension to .p12 or .pfx to install it. When you install a certificate from a PKCS#12 key store, Android also installs any accompanying private key or certificate authority (CA) certificates.

Load a Certificate

To use a certificate, you must install it in the trusted credential storage on the computer.

Note: Apps such as email and browsers that support certificates allow you to install certificates directly from within the app. For more information, see the help that comes with the app.

1. Copy the certificate or key store from your PC to the mobile computer.
2. Swipe up from the bottom of the Home screen to access all apps.
3. Tap **Settings**  > **Security** > **Encryption & credentials**.
4. Tap **Install a certificate**.
5. Select either **CA certificate**, **VPN & app user certificate**, or **Wi-Fi certificate**.
6. Tap the Menu icon , and then navigate to the location where you saved the certificate or key store.
7. Tap the certificate or key store to install it. If prompted, enter the key store password. Tap **OK**.
8. Type the name of the certificate.
9. Select **VPN and apps** or **Wi-Fi**.
10. Enter a name for the certificate and tap **OK**.

Disable or Remove Certificates

If a user or system certificate is compromised, or your organization chooses not to trust it, you can disable or remove the certificate.

1. Swipe up from the bottom of the Home screen to access all apps.
2. Tap **Settings**  > **Security** > **Encryption & credentials**.
3. Select **Trusted credentials**.

The trusted credentials screen has two tabs:

- **System** shows Certificate Authorities (CA) certificates permanently installed on the computer. They can only be disabled.
 - **User** shows CA certificates you have installed yourself. You can remove these certificates.
4. Tap the name of the certificate to you want to disable or remove. The Security certificate screen appears.
 5. Scroll to the bottom of the screen and tap **Disable** (for System certificates) or **Remove** (for User certificates).
 6. Tap **OK**.

Note: You can enable a disabled System certificate but if you remove a User certificate, you must install it again to enable it.

About Bluetooth Communications

Your mobile computer is equipped to communicate with other devices using Bluetooth technology. The Bluetooth radio must be turned On to discover, pair and connect to other Bluetooth devices. System bar icons indicate Bluetooth radio status.

Connect a Bluetooth Device

To connect to a Bluetooth device, you must turn On the Bluetooth radio and then select the device from a list of discovered devices.

1. Swipe up from the bottom of the Home screen to access all apps.
2. Tap **Settings**  > **Connected devices**.
3. Tap **+ Pair new device**. A list of Bluetooth devices appears.
4. Select a device on the list to initiate a pairing request.



5. When the pairing request message appears:
 - Verify the pairing PIN is the same on both device, and then tap **Pair**.

OR

- If the pairing request requires a PIN, enter the **PIN**, and then tap **Pair**.

When the device is successfully paired with the computer, the device name appears under Paired devices.

6. (Optional) Once paired to a device, you can connect manually to the device. Tap the device under Paired devices. The word “Connected” appears under the paired device name.

The status icon changes from  to .

- To disconnect a paired device, tap the name of the paired device and then tap **Forget**.



Rename the Computer

You can change the name of the computer to make it easier to identify when pairing with other Bluetooth enabled devices and view statistics about received files.

1. Swipe up from the bottom of the Home screen to access all apps.
2. Tap **Settings**  > **Connected devices** > **Connection preferences** > **Bluetooth**.
3. Tap **Device Name**. Type the new name and then tap **Rename**.

Rename, Share or Unpair a Paired Device



You can rename a paired device to make it easier to identify it on the list or unpair the device to remove it from the paired list.

1. Swipe up from the bottom of the Home screen to access all apps.
2. Tap **Settings**  > **Connected devices** > **Previously connected devices**.
3. Tap  next to the paired device.
4. Take one of the following actions:
 - To rename the device, tap the Edit  icon, type the new name, and then tap **RENAME**.
 - To allow **Internet access** or **Contact Sharing**, tap the check box next to the setting.
 - To unpair the device, tap **Forget**.

About the Scanner Edge App



Your mobile computer is equipped to communicate with scanners using Bluetooth technology through the Scanner Edge app. The Bluetooth radio must be turned on. System bar icons indicate Bluetooth radio status.

To turn on the Bluetooth radio:

1. Swipe up from the bottom of the Home screen to access all apps.
2. Tap **Settings**  > **Connected devices** > **Connection preferences** > **Bluetooth**.
3. If necessary, tap **Off**  to toggle the Bluetooth radio **On** .

Connect a Bluetooth Scanner

To connect to a Bluetooth scanner, the Bluetooth radio must be turned on and then scan a pairing barcode with the Bluetooth scanner.

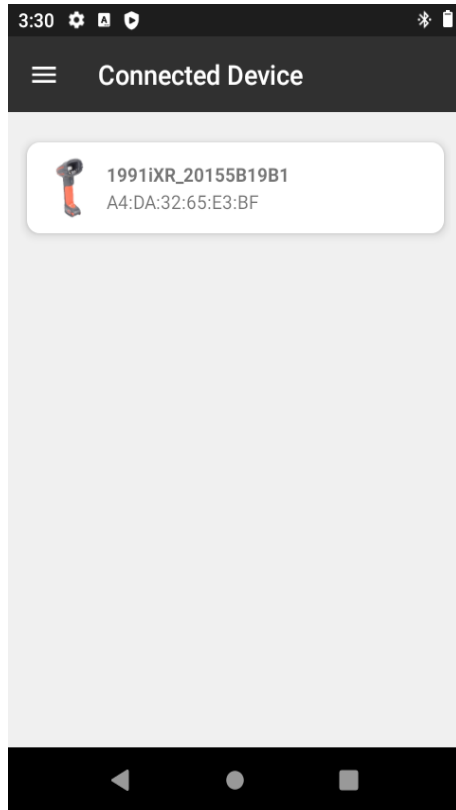

1. Swipe up from the bottom of the Home screen to access all apps.
2. Tap **Scanner Edge** .
3. Tap the menu icon  and then tap **Pair BT Scanner**.
4. For Honeywell branded scanners tap **Honeywell** or for Intermec branded scanners tap **Intermec**.
5. Scan the **Connect Barcode** displayed on screen.

- When the scanner is successfully paired with the computer, the scanner name appears under Connected Device.



Unpair a Paired Scanner

You can unpair the scanner to remove it from the Connected Device list.

- Swipe up from the bottom of the Home screen to access all apps.
- Tap **Scanner Edge** .
- Tap the menu icon  and then tap **Disconnect BT Scanner**.
- Tap **Honeywell** or **Intermec**.
- Scan the **Disconnect Barcode** displayed on screen.

About Serial and USB Communications

You can use these optional CK65 accessories to transmit data to and receive data from another device through serial or USB communications:

- Vehicle dock
- Home Base
- Ethernet Home Base

For information about these accessories, contact your local sales representative.

USB Troubleshooting

- If you have a problem with your workstation computer recognizing the USB device, try downloading and installing the Honeywell-aidc-usb-driver. The driver is part of the Honeywell_Mobility SDK_Android software.zip file. To learn where to get the software, see [Developer Information](#) on page 81.
- Check to make sure you have enabled the USB for file transfer. To learn more, see [Configure USB Connection and Transfer Files](#) on page 32.

About Near Field Communication (NFC)

NFC technology provides the ability for short-range, wireless data transfer between the CK65 and NFC tags or other NFC enabled devices placed in close proximity to the back of the computer. All CK65 mobile computers support the following modes of operation:

- NFC tag reader/writer mode: The computer reads and/or writes digital information from or to an NFC tag.
- Peer-to-Peer (P2P) mode: The computer uses Android Beam and/or Bluetooth technology to transfer screen content (e.g., a picture, contact information, Web page URL, or file) between NFC enabled devices.
- NFC card emulation mode: The computer emulates an NFC card (smart card) that an external card reader can access. You can download and install apps for card emulation mode from the Google Play Store. Some examples include digital wallets (e-wallets) offered by your bank or credit card company and Google Pay.

The app you install determines the type of emulation mode used: Card Emulation with a Secure Element or Host-based Card Emulation. Secure element use is common for financial transactions that require a high level of security in order to provide a secure memory and execution environment for running custom smart card applets and storing your personal information (e.g., account information and credentials).

Note: *When using a Universal Integrated Circuit (UICC) card for NFC Secure Element NFC link encryption, install the card in SIM slot 1.*

Developer Information

To download the Honeywell Mobility SDK for Android and EZConfig for Mobility:

1. Go to the Honeywell Technical Support Downloads Portal at <https://hsmftp.honeywell.com>.
2. Create an account if you have not already created one. You must login to download the software.
3. Install the *Honeywell Download Manager* tool on your workstation (e.g., laptop or desktop computer) prior to trying to download any files.
4. Navigate to the software:
 - *Honeywell Mobility SDK for Android*
Click on **Software** > **Software and Tools** > **Developer Library** > **SDKs for Android**.
 - *EZConfig for Mobility*
Click on **Software** > **Software and Tools** > **EZConfig for Mobility**.
5. Select **Download** next to the software zip file.

About Provisioning Mode

Once you complete the out-of-box initial setup process, Provisioning mode is automatically turned Off to improve device security against unwanted modifications to the system.

When Provisioning mode is turned Off (disabled):

- Configuration barcodes do not scan and process.
- \honeywell\autoinstall folders are inaccessible.

Note: To learn more about network and security for Honeywell mobile computers with Android operating systems, go to sps.honeywell.com.

Enable or Disable Provisioning Mode

1. Swipe up from the bottom of the Home screen to access all apps.
2. Tap **Settings**  > **Honeywell Settings** > **Provisioning mode**.
3. Tap the button to toggle the provisioning On or Off.

About Wi-Fi Staging

Overview

You can use the Honeywell Wi-Fi Staging app to quickly set up new devices by configuring one device and using it to stage others. Wi-Fi Staging can also be used to enroll devices in a Mobile Device Management (MDM) system by connecting units to a specified network and downloading and installing the specified MDM client app.

Once you have set up a configuration in the Wi-Fi Staging app on the server device, Wi-Fi staging will use that device as a hotspot and wait for a client to connect to it. The configuration will be distributed to the client device once communication is established between the client and the server device.

Staging Devices

Wi-Fi Staging requires two steps:

1. Setting up a master device to act as a server (see next section).
2. Setting up the client device (see [Set Up Client Devices](#) on page 85).

Set Up a Device as a Server

Wi-Fi Staging provides two kinds of configurations for a master device acting as a server through a hotspot. Setup of the server device will differ based on the staging configuration you choose:

- **Basic Configs** include the most common system settings:
 - System language
 - Bluetooth and NFC
 - System volume
 - Location
 - Network
 - File download
 - Application installation or launch
- **Advanced Configs** allow you to stage your devices with .xml files

The hotspot on the server device will be named HONEYWELL_WIFI_STAGING.

Note: We recommend starting the server before setting any clients because the clients require more time and power to scan and search for the hotspot signal if the server is not created in advance.

Note: To control bandwidth usage, the server side of Wi-Fi Staging has a maximum limitation of 10 concurrent client connections. If more than 10 client devices attempt to connect to the server device at the same time, staging of some of those clients will be delayed until client connections become available as the staging process progresses.

Basic Configuration

Basic configuration includes the most common system settings.

1. Launch the Wi-Fi Staging app on the server device by tapping **Settings** > **Honeywell Settings** > **Wi-Fi Staging**.
2. Tap **Basic Configs** to start the configuration wizard.
3. **System language:** Tap **+** to add a language. At least one language must be selected. Tap **NEXT**.
4. **Connection preferences:** Enable Bluetooth and/or NFC. They are disabled by default. Tap **NEXT**.
5. **Sound preferences:** Adjust the default volume for each type of audio by dragging the slider, then tap **NEXT**.
6. **Location setting:** Enable the location switch. It is disabled by default. Tap **NEXT**.
7. **Network & internet:** You have the option to set up a network connection if, for example, you want to register devices to an MDM system or the devices need to use applications that require network access.

If you do not want to set up a network connection, tap **SKIP** and proceed to Step 9.

If you want to set up devices to connect to a Wi-Fi access point, enter the network information:

- a. Tap **Wi-Fi Security** and select either OPEN or WPA/WPA2.
 - b. Enter the Wi-Fi SSID. This field cannot be empty. Then tap **OK**.
 - c. Enter the Wi-Fi password. The password must be between 8 and 63 characters long. If you selected WPA/WPA2 a password is required.
 - d. Tap **NEXT**.
8. **Files & Apks:** (This option will not display if you chose to skip the network settings in Step 7.) Enter the locations (URLs) of the files to be downloaded. The URL should end with the file that you want to download. Wi-Fi Staging will name the downloaded file with the file name in the URL.
 - For security, only Local Area Network URLs are supported. Wi-Fi Staging will ignore URLs from Wide Area Networks.

- Supported network protocol is HTTP or HTTPS.
 - APK files are installed silently and automatically after download.
 - Optional: You can include a file's hash in the file name. Wi-Fi Staging supports hash algorithms SH1 and SHA256.
9. **Final Setting:** Select whether you want to reboot the device after staging is complete. You can also specify an action (intent) to launch Android activities. Then tap **Next**.
 10. **Confirm & Staging:** Review the items you have configured. Tap **Confirmed, start staging now!** to begin. If you need to change a setting, tap the Back button to return to that screen.

Wi-Fi Staging will start a hotspot on the server device and wait for clients to connect.

11. Proceed to [Set Up Client Devices](#) on page 85.

Configurations will be distributed to any client that connects to the server device. Once the data transmission finishes successfully, the name and serial number of the configured client will display in the Wi-Fi Staging app on the server device, and the client device will skip the Android setup wizard.

Note: If you included a file's hash in Step 8, Wi-Fi Staging will validate that the hash of the file downloaded to a device matches what you specified. If the downloaded file's hash does not match, the file will be removed from the device.

Advanced Configuration

Advanced configuration allows you to stage your devices with one of more .xml files created by EZConfig or Enterprise Provisioner. For more information about generating .xml files, see the *PowerTools User Guide* or the *Enterprise Provisioner User Guide*.

Note: *Advanced Configuration supports .xml files only. Other file types will be ignored.*

Note: *Do not change the default names of .xml files. (For example, DeviceConfig.xml is acceptable, but DeviceConfig1.xml is not.)*

1. Choose one device to act as the server.
2. Launch Wi-Fi Staging app on the server by tapping **Settings > Honeywell Settings > Wi-Fi Staging**.
3. Tap **Advanced Configs**.
4. Tap **File directory**.
5. Specify where on the server device the .xml files to be downloaded are located.
6. Tap **NEXT**.
7. Choose the files to be applied. Tap **NEXT**.

8. Review the files you have selected. If you need to change any files, tap the Back button. Otherwise, tap **Confirmed, start staging now!** to begin.
Wi-Fi Staging will start a hotspot on the server device and wait for clients to connect.
9. Proceed to [Set Up Client Devices](#) on page 85.

Set Up Client Devices

The Wi-Fi Staging client runs automatically on the initial boot of a new device. However, it must be started manually on existing devices.

New Devices

This section applies to new, out-of-the box devices only. For existing devices, see the next section.

1. Set up a server device (see page [82](#)).
2. Place the new devices to be configured within 1 meter (3 feet) of the server device and turn them on.

When a new device boots up and begins the setup wizard, it will attempt to retrieve configuration from the server device, and a staging progress screen will display.

Note: *Client devices should be kept on the Android Welcome or setup wizard screen during staging. If you finish the setup wizard manually the client side of Wi-Fi Staging will stop running.*

Configurations will be distributed to any client that connects to the server device. Once the data transmission finishes successfully, the name and serial number of the configured client will display in the Wi-Fi Staging app on the server device, and the client device will skip the Android setup wizard.

Existing Devices

To start the Wi-Fi Staging client on an existing device:

1. Set up a server device (see page [82](#)).
2. Turn on the client device and launch the Wi-Fi Staging app by tapping **Settings > Honeywell Settings > Wi-Fi Staging**.
3. Tap **To be Staged**.
4. A message will display notifying you that the Wi-Fi settings on the client device will be reset as part of the staging process. Tap **OK** to confirm you wish to proceed.

Staging will begin and a progress screen will display.

5. Place the device within 1 meter (3 feet) of the server device and it will begin searching the server hotspot for a configuration.

The client devices will attempt to retrieve configuration from the server device and a staging progress screen will display. Once the client device receives and applies the configuration successfully, the progress screen will be dismissed.

Note: *To stop the staging process on an existing device, tap the Back button on the client device.*

Log Files

Wi-Fi Staging saves a key process and exception log on the device in the following directory: `/sdcard/honeywell/Android/data/com.honeywell.wifistaging/Log/`

This directory can be accessed through USB if Provisioning Mode is enabled.

MANAGE AND MAINTAIN THE COMPUTER

Use this chapter to understand how to upgrade software, reset, and maintain the computer.

About Software Updates and Cyber Security

Cyber security best practices include keeping your device apps and OS up to date. To help, Honeywell offers maintenance patches, security updates and operating system upgrades through our Honeywell Edge services.

Availability and cost depend on the following:

- Date of purchase of the device or software app.
- Warranty status.
- Service agreement status (devices) or Maintenance plan status (apps).

To learn more about Honeywell Edge Services, go to sps.honeywell.com and select **Services > Productivity > Support Services**.



Honeywell recommends routinely checking the [Cyber Security Notifications](#) page for critical Cyber Security Notifications and reviewing the latest [Network and Security Guide](#) available from the CK65 product page at sps.honeywell.com.

Software Downloads

Product support is available online through [Technical Support](#). Software updates can be accessed through the [Software Downloads](#) portal. You will need to create a login account for portal access. Additional information such as purchased date, service agreement number, maintenance plan number, or software license number may be required for downloads.

1. Go to <https://hsmftp.honeywell.com>.
2. Create a login account if you have not already created one.



3. Install the Honeywell Download Manager tool. See “Note” on the portal page. This tool is required for downloads.
4. Locate the app or upgrade you want to download in the Software directory.
5. If prompted, enter additional information, and click **Submit**.
6. Select **Download**. Follow the prompts to download the file.

About Transferring Files via USB Connection

If you plan on using a USB connection to transfer the upgrade files to the mobile computer, make sure you set the USB connection to allow file transfers. To learn more, see [Configure USB Connection and Transfer Files](#) on page 32.

Install Software with AutoInstall

Important: *The CK65 must have power for the entire length of the install process or it could become unstable. Do not attempt to remove the battery during the process.*

1. Swipe up from the bottom of the Home screen to access all apps.
2. Tap **Settings**  > **Honeywell Settings** > **Provisioning mode**.
3. Tap the toggle button to turn Provisioning mode **On**.
4. Save the upgrade file (*.zip or *.apk) in one of the following folders on the CK65 mobile computer:
 - **Internal shared storage\honeywell\autoinstall**
Software upgrades saved to this folder for installation, do not persist when an Erase all data (factory reset) or Enterprise data reset is performed.
 - **IPSM card\honeywell\autoinstall**
Software upgrades saved to this folder, do not persist when an Erase all data (factory reset) is performed. However, the upgrade does persist if an Enterprise data reset is performed.
5. Swipe up from the bottom of the Home screen to access all apps.
6. Tap **AutoInstall Settings**  and verify **Enable AutoInstall** is **On** .
7. Tap **Packages Update** from the AutoInstall Settings screen.



The computer automatically initiates a reboot and installs the software upgrade. The system update screen appears during the upgrade process. When the update is finished, the lock screen appears.
8. Once installation is complete, turn Provisioning mode Off.

Note: *Some updates do not require the computer to reboot before installation.*

Optional microSD Card Method

The CK65 comes equipped with a microSD card socket. You can install an upgrade from a microSD card you insert in the computer.

Important: *The CK65 must have power for the entire length of the install process or it could become unstable. Do not attempt to remove the battery during the process.*

1. On the CK65, swipe up from the bottom of the Home screen to access all apps.
2. Tap **Settings**  > **Honeywell Settings** > **Provisioning mode**.
3. Tap the toggle button to turn Provisioning mode On.
4. Tap **AutoInstall Settings** . Verify **Enable AutoInstall** is **On** .
5. Press and hold the **Power** button, and then tap **Power** > **Power off**.
6. On your workstation (e.g., laptop, desktop computer), format the microSD card and create a **\honeywell\autoinstall** folder on the root of the card.
7. Save the upgrade file (*.zip or *.apk) file in the **autoinstall** folder.
8. Install the microSD card in the CK65, and then turn on the computer.

The computer automatically runs the upgrade found in the autoinstall folder on the card. The system update screen appears during the upgrade process. When the upgrade is finished, the lock screen appears.

9. Once installation is complete, turn Provisioning mode **Off**.

About the Honeywell Upgrader

Use the Honeywell Upgrader app (HUpgrader) to check for and install OTA updates or view the current OTA version installed on the computer.

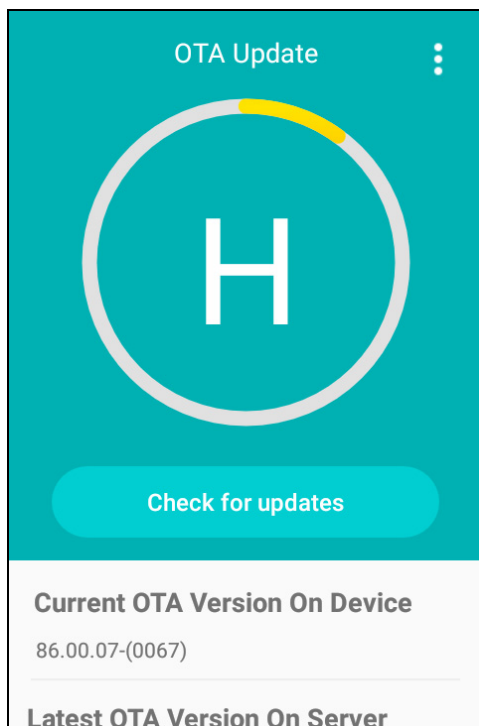

View the Installed OTA Version

1. Swipe up from the bottom of the Home screen to access all apps.
2. Tap **HUpgrader**  to open the Honeywell Updater app. The OTA version number installed on the computer appears on the screen.



Install OTA Updates

To use the HUpgrader to install an OTA update file downloaded from the [Technical Support Downloads Portal](#):

1. Swipe up from the bottom of the Home screen to access all apps.
2. Tap **Settings**  > **Honeywell Settings** > **Provisioning mode**.
3. Tap the toggle button to turn Provisioning mode **On**.
4. Save the OTA file (*.zip) in the following folder on the CK65 computer:
 - **Internal shared storage\Download**
5. Tap **HUpgrader**  to open the Honeywell Updater app.
6. Tap  in the upper right corner, and then tap **Select OTA from storage**.
7. Select the storage location (i.e., Internal Storage) where you saved the file.

8. Tap the OTA update file. The computer examines the file, and then starts the installation.

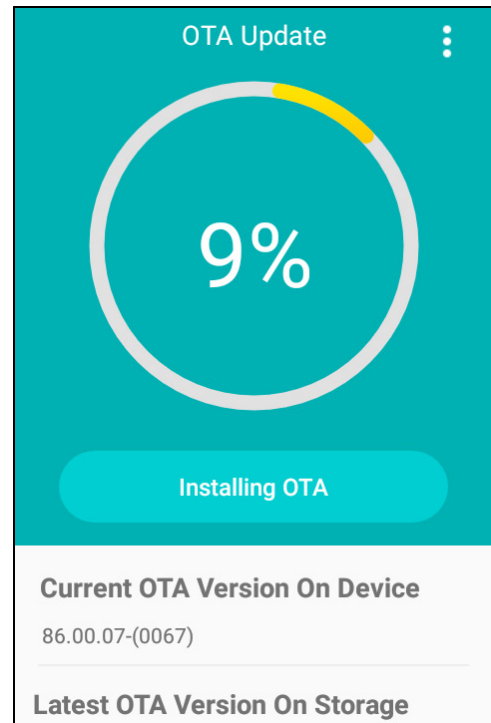
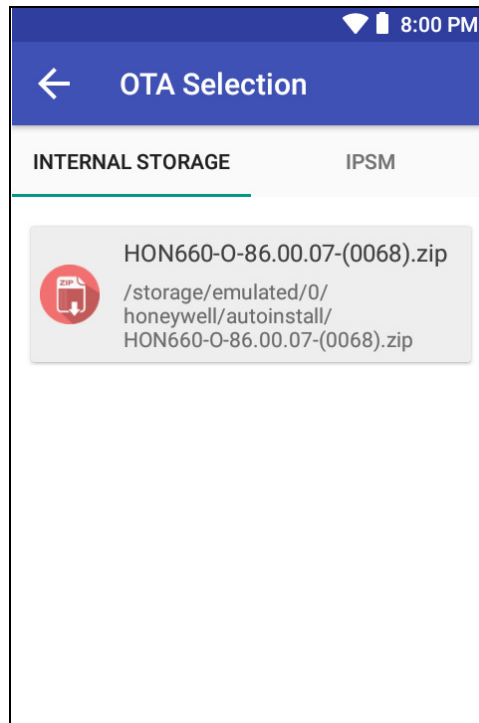

9. Once the installation is complete (100%), select **OK** when prompted to **Reboot** the computer. The computer reboots and finishes the update.

Restart (Reboot) the Computer

You may need to reboot the computer to correct conditions where an application stops responding to the system.

1. Save your files and close any open applications.
2. Press and hold the **Power** button until the options screen appears.
3. Tap **Power > Restart**.

If the touch panel display is unresponsive:

- Press and hold the **Power** button for approximately 8 seconds until the computer reboots.

About Enterprise Data Reset

You can perform an Enterprise data reset if a Reboot did not improve the condition and all other troubleshooting methods have not resolved the issue. This method provides a clean configuration for troubleshooting by erasing all data from the **Internal shared storage** location on the computer. Data is not erased from the IPSM Card location.





Caution: An Enterprise data reset results in data loss, only perform this procedure if all other recovery methods have failed. All personal content is erased including, but not limited to emails, pictures, contacts, Google account information, system settings and app settings.

Note: *This method of recovery may not be available if your system administrator has set policies to prevent the reset use.*

Before You Begin

- If you recently reset your Google Account password, wait 24 hours before performing an Enterprise data reset.
- Make sure you have your screen lock password, PIN or pattern if you activated one. You will need this to reset the computer.
- If you have a Google Account, back up your data and settings to your Google Account so you can restore them if needed.
- Connect the computer to an external power source or make sure you have a full battery charge.
- Make sure you have an Internet connection.

Enterprise Data Reset the Computer

1. Swipe up from the bottom of the Home screen to access all apps.
2. Select **Settings**  > **System** > **Advanced** > **Reset options**.
3. Tap **Enterprise data reset**.
4. Tap **Erase all data**.
5. If prompted, type your screen lock security pattern, PIN, or password and tap next ().
6. Tap **Erase all data**. A message appears informing you an Enterprise data reset is being performed.

About Erase All Data (Factory Reset)

A full Factory Reset should only be performed if you have exhausted all other troubleshooting options including an Enterprise data reset. This method reverts the computer back to the factory state by erasing all data in **Internal shared storage** and the **IPSM Card** storage locations on the computer.





Caution: A full Factory Reset results in data loss. Perform this procedure only if all other recovery methods have failed and have no other option. All personal content is erased including, but not limited to emails, pictures, contacts, Google account information, system settings and app settings.

Note: *This method of recovery may not be available if your system administrator has set policies to prevent the reset use.*

Before You Begin

- If you added a Google Account to the CK65 Series computer, make sure you have your Google username and password associated with the computer. If you do not have the username and password, you will not be able to use the computer after the reset. This is a security measure that prevents unauthorized users from using the device if they try a Full factory reset.
- If you did not add a Google Account to the computer, the extra security level is not enabled and you will not need a Google username and password.
- If you recently reset your Google Account password, wait 24 hours before performing a Full factory reset.
- Connect the computer to an external power source or make sure you have a full battery charge.
- Make sure you have an Internet connection.

Erase All Data (Factory Reset)

1. Swipe up from the bottom of the Home screen to access all apps.
2. Select **Settings**  > **System** > **Advanced** > **Reset options**.
3. Tap **Erase all data (factory reset)**.
4. Tap **Erase all data**.
5. If prompted, type your screen lock security pattern, PIN, or password and tap next ().
6. Tap **Erase all data**. A message appears informing you a Full factory reset is being performed.

Repairs

Repairs and/or upgrades are not to be performed on this product. These services are to be performed only by an authorized service center (see [Customer Support](#) on page vii).

Maintenance

Your device provides reliable and efficient operation with a minimum of care. Although specific maintenance is not required, the following sections describe periodic checks to ensure dependable operation.

Clean the Computer

The CK65 housing, scanner window, camera window and touch screen may be cleaned with a soft cloth dampened with water or a mild detergent-water solution. If a mild detergent solution is used, wipe the computer with a clean cloth dampened only with water to remove any detergent residue.

Note: *Always turn off the CK65 and leave the battery installed when you clean the computer.*

Note: *Reading performance may degrade if the scanner window is not clean. If the window is visibly dirty, or if the scanner is not operating well, clean the window.*



Caution: **Do not submerge the computer in water or cleaning solution. Do not use abrasive wipes or cloths on the windows or touch screen. Abrasive wipes may scratch the windows and touch screen. Never use solvents (e.g., acetone) on the housing or window. Solvents may damage the computer finish, the windows or touch screen.**

Caution: **Ensure all components are dry prior to mating the computer with charging accessories or other peripheral devices. Mating wet components may cause damage not covered by the warranty.**

About Disinfectant-Ready Models

Note: *CK65 models for use in hazardous locations are not available with disinfectant-ready housing.*

Some configurations of CK65 computers are available with an external plastic housing that is designed to resist the effects of harsh chemicals. These scanners are equipped with disinfectant-ready (DR) housings for the general-purpose market.

Please refer to the Honeywell Safety and Productivity Solutions website for specific details on how to clean CK65 computers with disinfectant-ready housings. Helpful information on the care of these specialty products can be found in the following article:

- [Honeywell Instructions for Cleaning General Purpose Disinfectant-Ready Housing Devices](#)

How to Identify Models with DR Housing

Since 2021, all standard and cold storage CK65 models have been equipped with disinfectant-ready housing. Previously, a water droplet  on the front of the computer indicated CK65 models with disinfectant-ready housing.

The first two digits of the serial number indicate the year the computer was manufactured.

- If the serial number of your (non-hazardous-location) computer begins with 21 or higher, it has disinfectant-ready housing.
- If the serial number begins with 20 or lower and your computer does not have a water droplet, it does not have disinfectant-ready housing.

Computer Agency Information

CK65 mobile computers meet or exceed the requirements of all applicable standards organizations for safe operation. The best way to ensure safe operation is to use the mobile computer according to the agency guidelines on the product regulatory sheet, quick start guide, battery insert and in this user guide. Read all guidelines before using your computer.

Product documentation is available for download from sps.honeywell.com.

Public certificates are available for download from honeywell.com/PSScompliance.

Label Locations

Labels inside the battery compartment contain information about the computer including, compliance information, model number, serial number and MAC address. Laser safety labeling is located on the back of the computer.

Product Identification Numbers
(e.g., Serial Number, MAC address or IMEI)

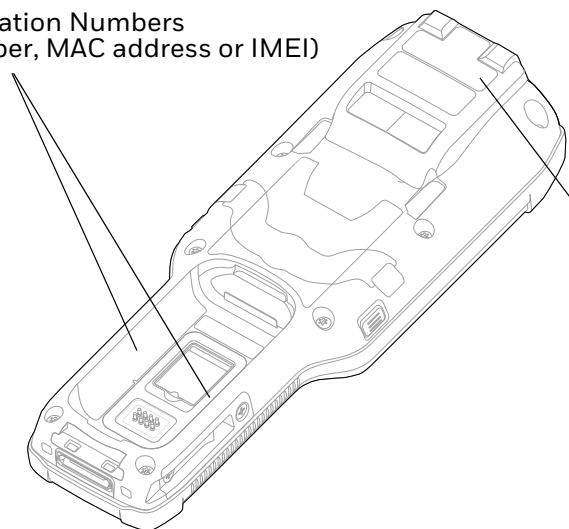

Laser Safety Label
Location

Physical and Environmental Specifications

1. Go to sps.honeywell.com.
2. Type CK65 in the Search box and then press **Enter**.
3. Click *CK65 Handheld Computer*.
4. Select one of the following:
 - **Specifications**
View System Architecture, Wireless Connectivity, Mechanical, and Environmental specifications.
 - **Resources**
Download the Data Sheet, Accessory Guide, Quick Start Guide, User Guide, Regulatory Information, Battery Information and other product documentation.

Barcode Symbologies Supported

The computer supports the following barcode symbologies:

1D Symbologies		2D Symbologies		Postal Codes	
	Default		Default		Default
Codabar	Enabled	Aztec Code	Enabled	Australian Post	Disabled
Code 39	Enabled	Codablock A	Disabled	British Post	Disabled
Code 32	Disabled	Codablock F	Disabled	Canadian Post	Disabled
Code 11	Disabled	DataMatrix	Enabled	China Post	Disabled
Code 93	Disabled	DotCode	Disabled	InfoMail	Disabled
Code 128	Enabled	Grid Matrix	Disabled	Japanese Post	Disabled
Composite	Disabled	HanXin	Disabled	Korean Post	Disabled
Digimarc Barcode	Disabled	Maxicode	Disabled	Netherlands (KIX) Post	Disabled
EAN-8	Enabled	PDF 417	Enabled	2D Postal Settings	Disabled
EAN-13	Enabled	QR Code	Disabled	Planet Code	Disabled
GS1-128	Enabled	TLC 39	Disabled	Postnet	Disabled
GS1 DataBar	Disabled	OCR-A	Disabled		
IATA 2 of 5	Disabled	OCR-B	Disabled		
Standard 2 of 5	Disabled				
Interleaved 2 of 5	Enabled				
ISBT 128	Disabled				
Matrix 2 of 5	Disabled				
MSI	Disabled				
Telepen	Disabled				
Trioptic Code	Disabled				

1D Symbologies		2D Symbologies		Postal Codes	
	Default		Default		Default
UPC-A	Enabled				
UPC-E	Enabled				
UPC-E1	Disabled				

Note: To learn about changing the symbology settings, see [Change the Scanner Settings](#) on page 46.

S0803 FlexRange Imager Reading Distances

The depth of field measurements used the following parameters:

- Distances are measured from the front of the Imager
- +23°C (+73°F), 200 lux
- Photographic quality codes

Note: Time to Read and Depth of Field will be impacted if the barcode symbol is at the edge of the image.

Focus		Standard Range	
Symbology		Near Distance	Far Distance
5 mils Code 39	mm	138	365
	in.	5.43	14.37
10 mils 128	mm	94	1491
	in.	3.7	58.7
13 mils UPC-A	mm	68	2000
	in.	2.68	78.74
20 mils Code 39	mm	63	5600
	in.	2.48	220.47
10 mils Data Matrix	mm	152	387
	in.	5.98	15.24
55 mils Code 39 ¹	mm	-	12500
	in.	-	492.13
100 mils Code 39 ^{1,2}	mm	-	20000
	in.	-	787.4
100 mils Data Matrix ¹	mm	-	6500
	in.	-	255.91

Focus		Standard Range	
Symbology		Near Distance	Far Distance
¹ Minimum distance depends on the length of the barcode. ² Typical code wide to narrow elemental ratio is 3:1. Minimum 100 mils code height of 3 inches			

S0803FR Imager Engine Field of View/Resolution

Focus	
Horizontal Field Angle (degrees)	46.7°
Vertical Field Angle (degrees)	27.9°

Far Field (Discrete Focus Lens Module)	
Horizontal Field Angle (degrees)	13.7°
Vertical Field Angle (degrees)	7.8°

DPI can be calculated based on the following formula:

Horizontal DPI = 1920 pixels/width of horizontal field of view (inches)

Vertical DPI = 800 pixels/width of vertical field of view (inches)

Note: Vertical resolution will be set to 800 to match resolution of the far field sensor.

N6803 FlexRange Imager Reading Distances

The depth of field measurements used the following parameters:

- Distances are measured from the front of the Imager
- +23°C (+73°F), 200 lux for guaranteed, 200 lux for typical
- Photographic quality codes

Note: Time to Read and Depth of Field will be impacted if the barcode symbol is at the edge of the image.

Guaranteed Specs

Focus		Standard Range	
Symbology		Near Distance	Far Distance
5 mils Code 39	mm	138	365
	in.	5.43	14.37
10 mils Data Matrix	mm	152	387
	in.	5.98	15.23

Focus		Standard Range	
Symbology		Near Distance	Far Distance
10 mils Code 39	mm	94	1198
	in.	3.7	47.17
13 mils UPC-A	mm	68	1437
	in.	2.68	56.57
15 mils Code 128	mm	66	1571
	in.	2.59	61.85
20 mils Code 39	mm	63	2161
	in.	2.48	85.07
100 mils Data Matrix ¹	mm	-	4505
	in.	-	177.36
55 mils Code 39 ¹	mm	-	6546
	in.	-	257.72
100 mils Code 39 ^{1,2}	mm	-	9843
	in.	-	387.51
¹ Minimum distance depends on the length of the barcode. ² Typical code wide to narrow elemental ratio is 3:1. Minimum 100 mils code height of 3 inches			

Typical Specs

Focus		Standard Range	
Symbology		Near Distance	Far Distance
5 mils Code 39	mm	122	414
	in.	4.8	16.3
10 mils Data Matrix	mm	135	419
	in.	5.31	16.5
10 mils Code 39	mm	85	1368
	in.	3.35	53.86
13 mils UPC-A	mm	60	1600
	in.	2.36	62.99
15 mils Code 128	mm	58	1894
	in.	2.28	74.57
20 mils Code 39	mm	56	2645
	in.	2.2	104.13
¹ Minimum distance depends on the length of the barcode. ² Typical code wide to narrow elemental ratio is 3:1. Minimum 100 mil code height of 3 inches.			

Focus		Standard Range	
Symbology		Near Distance	Far Distance
100 mils Data Matrix ¹	mm	-	5641
	in.	-	222.09
55 mils Code 39 ¹	mm	-	7159
	in.	-	281.85
100 mils Code 39 ^{1,2}	mm	-	10815
	in.	-	425.78

¹ Minimum distance depends on the length of the barcode.
² Typical code wide to narrow elemental ratio is 3:1. Minimum 100 mil code height of 3 inches.

N6803FR Imager Engine Field of View/Resolution

Focus	
Horizontal Field Angle (degrees)	48
Vertical Field Angle (degrees)	21

Note: *DPI can be calculated based on the following formula:
Horizontal DPI = 1920 pixels/width of horizontal field of view (inches)
Vertical DPI = 800 pixels/width of vertical field of view (inches)*

N6703SR Imager Engine Reading Distances

The depth of field measurements were taken using these parameters:

- Distances are measured from the front of the engine
- +23 °C (+73 °F), 0 lux
- Photographic quality codes

Note: *Time to Read and Depth of Field are impacted if the barcode symbol is at the edge of the image.*

Symbology		Near Distance	Far Distance
5 mil Code 39	mm	79	270
	in.	3.11	10.63
10 mil Code 39	mm	40	450
	in.	1.34	17.72
20 mil Code 39	mm	44	674
	in.	1.50	26.53

Symbology		Near Distance	Far Distance
13 mil 100% UPC-A	mm	44	515
	in.	1.50	20.27
15 mil Code 128	mm	42	572
	in.	1.42	22.52
10 mil Data Matrix	mm	83	236
	in.	3.27	9.29
5 mil PDF417	mm	119	177
	in.	4.68	6.97
6.7 mil PDF417	mm	96	236
	in.	3.78	9.29
6.7 mil QR	mm	123	147
	in.	4.84	5.79
15 mil QR	mm	39	390
	in.	1.30	15.35

N6703SR Imager Engine Field of View/Resolution

Focus	
Horizontal Field Angle (degrees)	48
Vertical Field Angle (degrees)	31

Note: DPI can be calculated based on the following formula:
 Horizontal DPI = 832 pixels/width of horizontal field of view (inches)
 Vertical DPI = 640 pixels/width of vertical field of view (inches)

EX20 Imager Engine Reading Distances

The depth of field measurements were taken using these parameters:

- Distances are measured from the front of the engine.
- +23 °C (+73 °F), 0 lux
- Photographic quality codes

Note: Time to Read and Depth of Field are impacted if the barcode symbol is at the edge of the image.

Symbology		Near Distance	Far Distance
3 mil Code 39	mm	120	740
	in.	4.7	29.1

Symbology		Near Distance	Far Distance
4 mil Code 39	mm	120	1010
	in.	4.7	39.8
10 mil Code 39	mm	100	2200
	in.	3.9	86.6
20 mil Code 39	mm	200	4160
	in.	7.9	163.8
40 mil Code 39	mm	390	5990
	in.	15.3	235.8
55 mil Code 39	mm	530	6960
	in.	20.9	274
13 mil EAN-UPC	mm	160	2190
	in.	6.3	86.2

EX20 Imager Engine Field of View/Resolution

Focus	
Horizontal Field Angle (degrees)	14.0°
Vertical Field Angle (degrees)	8.7°

Note: *DPI can be calculated based on the following formula:
Horizontal DPI = 832 pixels/width of horizontal field of view (inches)
Vertical DPI = 640 pixels/width of vertical field of view (inches)*

Honeywell
855 S. Mint Street
Charlotte, NC 28202

sps.honeywell.com