



THE POWER OF **CONNECTED**

RP2B/RP2D/RP4B/RP4D

Thermal Printers

Quick Start Guide

Get Started

1. Remove the battery from the printer then remove the red battery isolator.

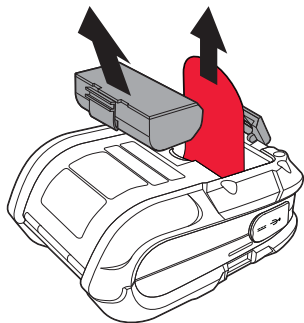
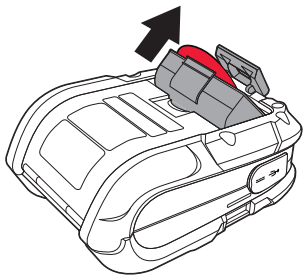

2. Reinstall the battery in the printer. Align the release tab with the same side as the charge contacts and lock the battery into position. The latch clicks into place when properly seated.

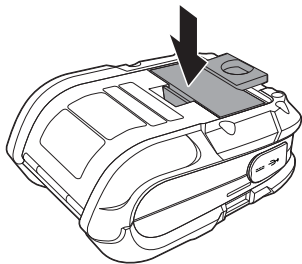
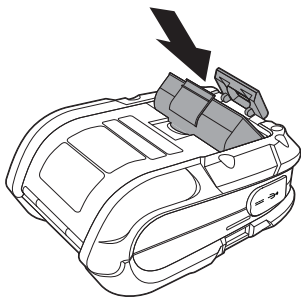

3. Connect the power supply to printer's power jack.
4. Connect the AC power cord to the power supply and plug into an outlet.

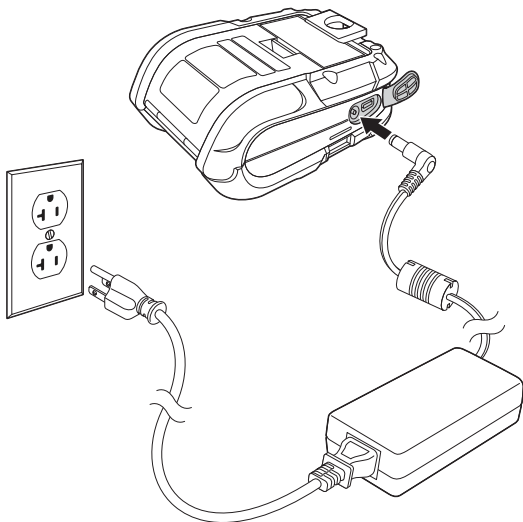

Do not operate the printer while it is connected to the AC power supply.

Load Labels or Paper

Load labels or paper into the printer as follows:

1. Press down on the latch lock and lift up the printer's cover.

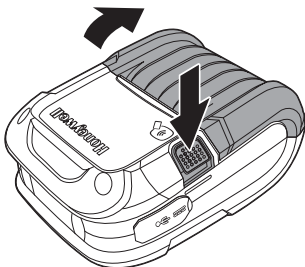

2. Slide and hold open the supply hubs.

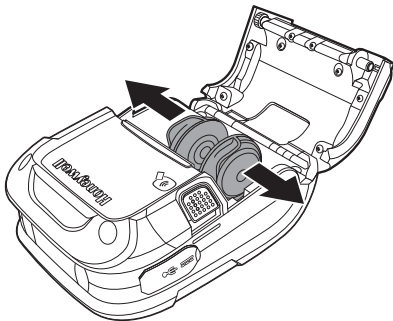

3. Orient the paper as shown and insert into the printer.

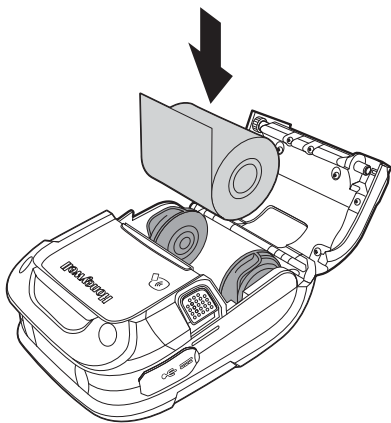

4. Allow the supply hubs to retract onto the paper roll, then press the cover down until it latches.
5. Press the media button  2 or 3 times to normalize tracking. Each button press advances the paper to the start of the next label.

Download Required Software

1. Create a new folder on your local computer named **Drivers**.
2. Go to the Technical Support Downloads Portal at <https://hsmftp.honeywell.com>.

3. Go to:
 - Software**
 - **Printers**
 - **Mobile - Portable**
 - **RP2 RP3 RP4**
 - **Utility**to download the NETira® CT Printer Configuration Utility.
4. When prompted, click on **Open Honeywell Software Downloader**.
5. Once the file has been downloaded, extract it to your **Drivers** folder.
6. Go to:
 - Software**
 - **Printers**
 - **Mobile - Portable**
 - **RP2 RP3 RP4**
 - **Drivers**
 - **Printer**to download the Windows Printer Drivers (for DPL Input Mode).
7. When prompted, click on **Open Honeywell Software Downloader**.
8. Once the file has been downloaded, extract it to your **Drivers** folder.
9. Open the Drivers folder and double-click each of the setup.exe files. Follow the prompts to install each piece of software.

Add the Printer to Your Host System

The default USB class is CDC Composite. On some systems (e.g., handheld devices), you will have to change this USB class in order to connect. See your User Guide for further information.

1. Connect the USB cable to the printer and to the USB port on the host system.
2. Power up your printer.
3. Your host computer should recognize the printer and begin adding the device driver. If the setup operation does not start, locate the **Devices and Printers** section in the Control Panel and select **Add a Printer**.
4. Select the appropriate RP printer model and follow the prompts to finish installation.

Configure the Printer

1. Turn the printer on and connect it to the computer using the USB cable.
2. Open the NETira™ CT Printer Configuration Utility Tool.

3. Query the printer by clicking **Tools - Update Available Connections For Printer**. This will look for the USB Virtual COM Port.

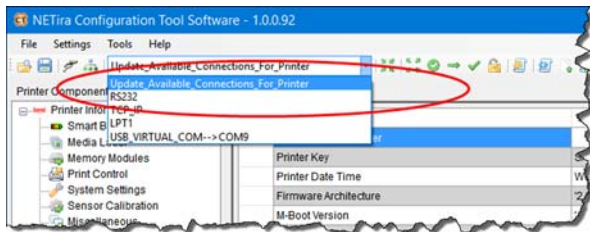

4. Once this is completed, reopen the dropdown menu and select the USB Virtual COM port.

Note: Make sure this port is not in use by the printer driver when you add it to the host system.

5. Press **CTRL-q** to display the printer's configuration.

See your User Guide for detailed information about changing the printer's settings.

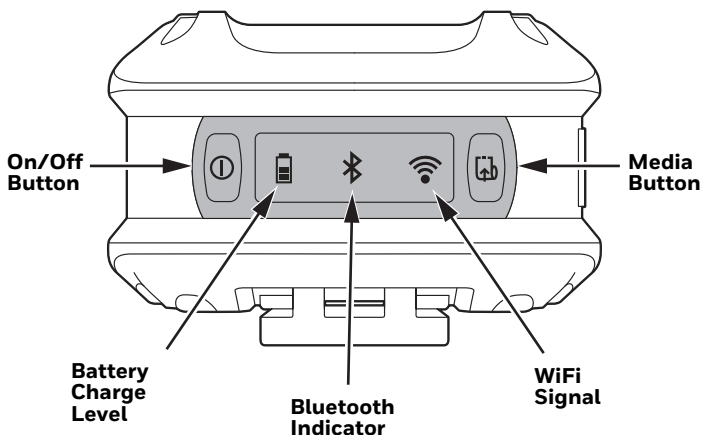

Front Panel



On/Off Button ⓘ

Button Press	Result
Any length press when printer is off	Turn printer on
Short press (less than 5 seconds)	Enter or exit sleep mode
Medium press (5 - 10 seconds)	Print configuration label
Long press (more than 10 seconds)	Turn printer off

LED Display

Icon	Indication
 Battery charge level	When not charging: Off = Battery is midway to fully charged Solid orange = Battery charge is 10-30% Blinking red = Battery charge is 10% or less When charging: Solid green = Battery charge is 90% or more Solid red = Battery charge is less than 90%
 Bluetooth indicator	Off = Bluetooth radio is off, disabled, not associated with a mobile device, or printer is off Solid blue = Bluetooth is enabled and connected
 WiFi signal	Off = WiFi radio is off, disabled, not associated with a mobile device or network, or printer is off White = WiFi is enabled and connected

Media Button

The media button advances the paper through the printer. When there is no paper in the printer, the button blinks red.

Button Press	Result
Short press	Feeds label or paper length
Press and hold (when configured for continuous form receipt paper)	Media feeds continuously to the maximum label length

Audible Indicators

Beeps	Indication
1 long beep	Power supply disconnected
2 short beeps every 5 seconds	No media
2 long beeps	Power supply connected
3 short beeps	Battery charge is low
5 short beeps	Printer door open

Support

To search our knowledge base for a solution or to log into the Technical Support portal and report a problem, go to www.hsmcontactsupport.com.

Limited Warranty

For warranty information, go to www.honeywellaidc.com and click **Get Resources > Product Warranty**.

Patents

For patent information, see www.hsmpats.com.

Disclaimer

Honeywell International Inc. (“HII”) reserves the right to make changes in specifications and other information contained in this document without prior notice, and the reader should in all cases consult HII to determine whether any such changes have been made. The information in this publication does not represent a commitment on the part of HII.

HII shall not be liable for technical or editorial errors or omissions contained herein; nor for incidental or consequential damages resulting from the furnishing, performance, or use of this material. HII disclaims all responsibility for the selection and use of software and/or hardware to achieve intended results.

This document contains proprietary information that is protected by copyright. All rights are reserved. No part of this document may be photocopied, reproduced, or translated into another language without the prior written consent of HII.

Copyright © 2017 Honeywell International Inc. All rights reserved.