

Dolphin CT50 & CT50h

Mobile Computer
with Android™ 4.4 Operating System



User Guide

Disclaimer

Honeywell International Inc. (“HII”) reserves the right to make changes in specifications and other information contained in this document without prior notice, and the reader should in all cases consult HII to determine whether any such changes have been made. The information in this publication does not represent a commitment on the part of HII.

HII shall not be liable for technical or editorial errors or omissions contained herein; nor for incidental or consequential damages resulting from the furnishing, performance, or use of this material. HII disclaims all responsibility for the selection and use of software and/or hardware to achieve intended results.

This document contains proprietary information that is protected by copyright. All rights are reserved. No part of this document may be photocopied, reproduced, or translated into another language without the prior written consent of HII.

Trademarks

Android, Google, and other marks are trademarks of Google Inc.

Microsoft, Windows are either registered trademarks or registered trademarks of Microsoft Corporation in the United States and/or other countries.

The Bluetooth trademarks are owned by Bluetooth SIG, Inc., U.S.A. and licensed to Honeywell.

Other product names mentioned in this manual may be trademarks or registered trademarks of their respective companies and are the property of their respective owners.

Patents

For patent information, see www.hsmpats.com.

Copyright © 2015–2016 Honeywell International Inc. All rights reserved.

Contents

Customer Support	vii
Product Service and Repair	vii
Limited Warranty	vii
Send Feedback	vii

1 About the Computer Features 1

About the Dolphin CT50 Mobile Computer	2
--	---

About the Battery	6
Charge the Battery	6
Change the Battery	7
About the Battery Status Icon	9
Change the Battery Status LED Behavior	11
Check the Battery Level	12
About Battery Life and Conservation	12
Battery Recommendations and Safety Precautions	13
Enable Airplane Mode	13

Power On the Computer	14
---------------------------------	----

Unlock the Screen	15
-----------------------------	----

About the Good Read LED	16
-----------------------------------	----

Configure the Screen Backlight	17
--	----

About the Audio Features	17
Adjust Ringtone and Notification Volume	17
Enable Vibrate Mode	19
Audio Settings	20

Insert a microSD Card	21
---------------------------------	----

How to Transfer Files	24
---------------------------------	----

How to Browse Files on the Computer	24
---	----

Accessories for the Computer	25
--	----

2 About the User Interface and Applications 27

About the User Interface	28
About the Home Screen	28
Navigation and Function Buttons	29
About Status Bar Icons	29
Remap a Button	30
View Notifications	31
Manage Notifications	31
Customize the Home Screen	32
Customize the Favorites Tray	32
Use Google™ Search	32
About Screen Gestures	33
Set the Time Zone	33
About Honeywell Applications	34
Download Honeywell Launcher	35
Unlock Developer Options	36

3 About the Scanner 37

About the Scanner	38
How to Scan Bar Codes as Keyboard Input	38
Change the Scanner Settings	38
Restore Default Scanner Settings	38
Scanners Default Settings	39
Data Processing Settings	39
Symbology Settings	41
Decode Settings	42
Imager Settings	43
Trigger Settings	43
Notification Settings	43
Scan a Bar Code	44

4 Use the Phone 45

About the Phone	46
Activate the UMTS Phone	46
Activate the CDMA Phone	49
Make a Phone Call	49
Answer the Phone	50
Switch Apps During a Phone Call	50

Check Your Voicemail 50
 Set Your Voicemail Number 51
 Change Voicemail Settings 51

Make an Emergency Phone Call. 51

Configure Phone Settings 51

5 Use the Camera 53

About the Color Camera 54

Adjust the Camera and Video Settings 54
 How to Zoom 54
 Change Camera Settings 54

Take a Photo 54

Record a Video 55

Change Video Settings 55

6 Configure the Computer 57

How to Configure the Computer 58
 Start the Settings App 58
 About the Structure of the Settings App. 58

About Network Communications 62
 Connect to a Wi-Fi Network 62
 Configure Proxy Settings for a Wi-Fi Network. 63
 Disable Wi-Fi Notifications 64
 Connect to an Ethernet Network 64
 How to Connect to Virtual Private Networks 65
 Add a VPN. 65
 Connect to a VPN 65
 Edit VPN Information. 66

About Wireless Security 66
 About Certificates. 66
 Load a Certificate 67
 Disable or Remove Certificates. 67

Contents

About Bluetooth Communications 68
 Connect a Bluetooth Device 68
 Configure Bluetooth Settings 70
 Making the Computer Discoverable 70
 Rename or Disconnect a Paired Device. 70

About Serial and USB Communications 71

About Near Field Communication (NFC). 71

7 Manage and Maintain the Computer 73

How to Upgrade the System Software 74

How to Restart the Computer 74

 Reset the Computer 75

 Clean Boot the Computer. 75

Clean the Computer 76

A Specifications 79

Physical and Environmental Specifications 80

Customer Support

If you need assistance installing or troubleshooting your product, contact us by using one of these methods:

Knowledge Base: www.hsmknowledgebase.com

Our Knowledge Base provides thousands of immediate solutions. If the Knowledge Base does not help you solve your problem, log into the Technical Support Portal to submit your problem or ask your question.

Technical Support Portal: www.hsmsupportportal.com

Log into the Technical Support Portal to search our Knowledge Base, submit your problem or question, request a call back, or provide feedback. When filling out one of the forms, provide as much detail as possible. You can even include attachments.

Telephone: www.honeywellaidc.com/locations

For our latest contact information, please check our website.

Product Service and Repair

Honeywell International Inc. provides service for all of its products through service centers throughout the world. To find your service center, go to www.honeywellaidc.com and select **Support > Contact Support > Service and Repair**. Contact your service center to obtain a Return Material Authorization number (RMA #) before you return the product.

To obtain warranty or non-warranty service, return your product to Honeywell (postage paid) with a copy of the dated purchase record.

Limited Warranty

For warranty information, go to www.honeywellaidc.com and click **Resources > Warranty**.

Send Feedback

Your feedback is crucial to the continual improvement of our documentation. To provide feedback about this manual, please contact the Technical Communications department directly at ACSHSMTechnicalCommunications@honeywell.com.

1

About the Computer Features

This chapter introduces the Dolphin® CT50 and CT50h Healthcare Mobile Computers with the Android 4.4 operating system. Use this chapter to learn about the basic computer features, functions, and accessories.

About the Dolphin CT50 Mobile Computer

The Honeywell Dolphin CT50 Mobile Computer is an enterprise-focused smartphone that uses the Android operating system to provide reliable and secure management of corporate data and wireless communications. The CT50 offers key features such as a large display, long-lasting battery, bar code imager, and rugged durability. The healthcare version of the CT50 is called the Dolphin CT50h Healthcare Mobile Computer. The CT50h has blue buttons and was designed to withstand the healthcare environment. Throughout this user guide, "computer" refers to both models CT50 and CT50h unless specifically stated.

- Android 4.4 operating system
- 2 GB DRAM, 16 GB flash memory
- Large, sunlight-readable display with responsive multi-touch screen
- Glove operation touch screen
- High performance 2D imager with ergonomic scan buttons
- IEEE 802.11a/b/g/n (ac if supported) radio
- Bluetooth 4.0 radio
- NFC technology for short-range wireless data exchange
- Value-added software components supporting specialized imaging and OCR functions
- Mid-tier rugged specifications with IP54 (CT50h) or IP67 (CT50) sealing
- Customer-accessible microSD™ slot for removable memory cards (up to 32 GB)
- Integrated GPS receiver (with WWAN radio option) (not available on the CT50h)
- 8-megapixel color camera
- Receiver Category 3 in accordance with EN 300 440-1



Caution: The CT50h Healthcare Mobile Computer shall not be used directly for active patient monitoring purposes or used for displaying alerts and alarms directly from a patient's medical device.

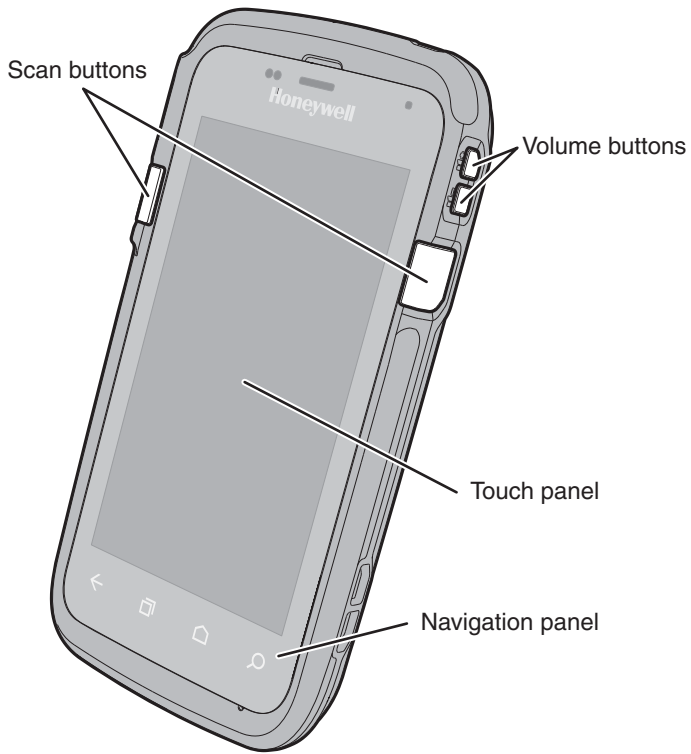

Front View of the CT50

Chapter 1 — About the Computer Features

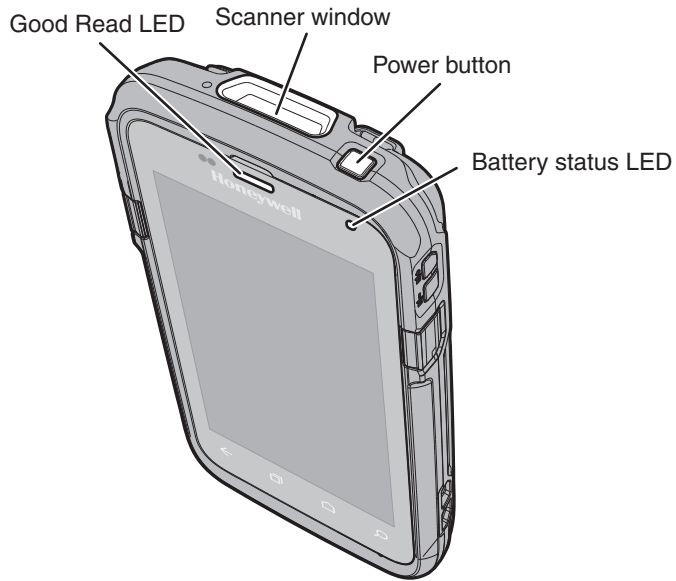

Top View of the CT50

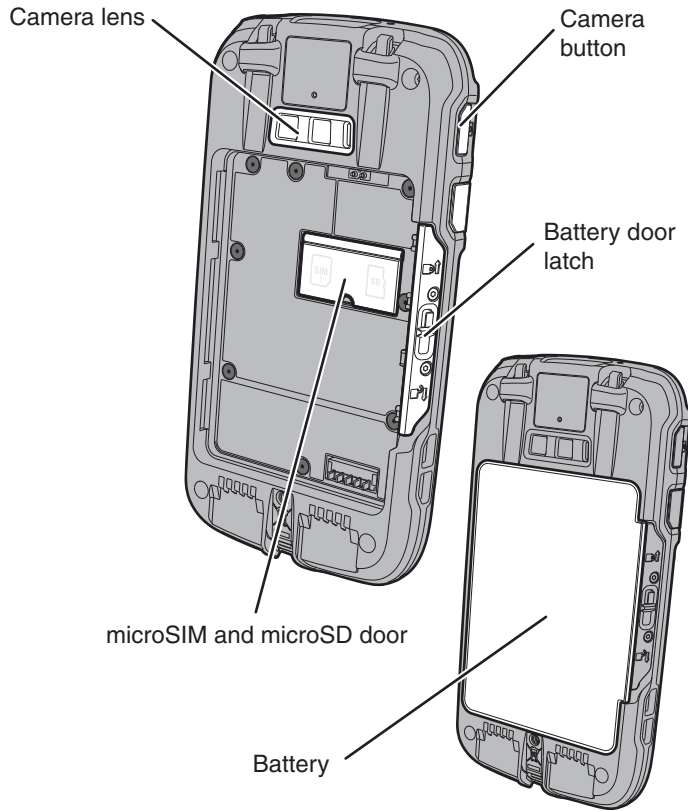

Back View of the CT50

About the Battery

The computer uses a rechargeable 3.6 V Li-ion battery as its main power source. The battery has a 14.6 watt hour capacity. Several factors determine the life of your battery, such as display brightness, display timeout, input device, extreme temperature, and your usage.

The CT50h battery (P/N 318-055-002) has the same specifications as the CT50 battery (P/N 318-055-001), but it is made out of specialty plastic designed for healthcare environments. The batteries are not interchangeable. Use only the battery designed for your model of computer.

Honeywell recommends that you keep the battery charged at all times to prevent data loss. When you change the battery, the computer automatically goes into a power-off state and then cold boots.

Contact your local sales representative for replacement batteries.



Caution: The battery used in this device may present a fire or chemical burn hazard if it is mistreated. Do not disassemble it, heat it above 100 °C (212 °F), or incinerate it. Dispose of used batteries promptly. Keep away from children.



Caution: We recommend the use of Honeywell Li-ion battery packs. The use of any non-Honeywell battery may result in damage not covered by the warranty. A non-Honeywell battery will not be charged in the device or in a Honeywell charger.

Charge the Battery

Make sure you fully charge the battery (Model CT50-BTSC) before you use your computer. You can charge the battery before or after you install it in the computer. It takes about 6 hours for the battery to fully charge in any of the accessories

- Insert the battery into a Quad Battery Charger or the battery well of an eHomeBase.

or

- Insert the computer with the battery installed into an eHomeBase, ChargeBase, NetBase, Quad Battery Charger, USB Adapter, or Vehicle Power Adapter.

Change the Battery

If your battery power is low, you need to either charge the battery in the computer, or replace it with a charged battery.

- 1 Save your files and close any open applications.
- 2 Press and hold the **Power** button. This screen appears:

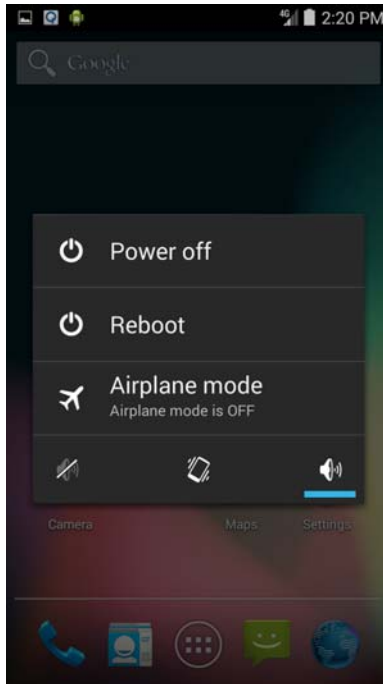

- 3 Tap **Power off**.
- 4 When prompted that the computer will shut down, tap **OK**.

- 5 Disconnect the handstrap from the bottom of the computer. If you have a CT50h, you do not have a handstrap.

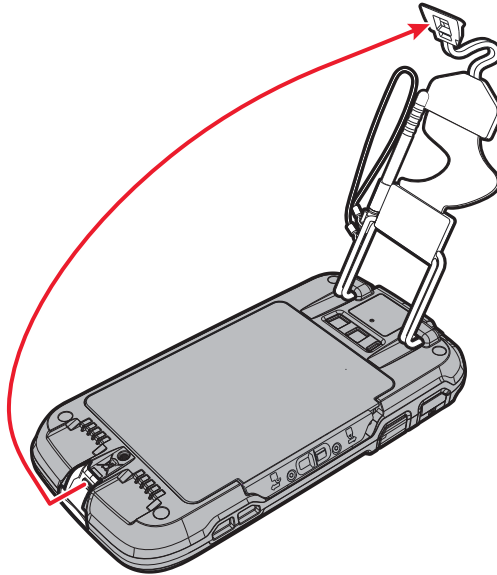

- 6 Press and slide the battery door toward the bottom of the computer to unlock the door.

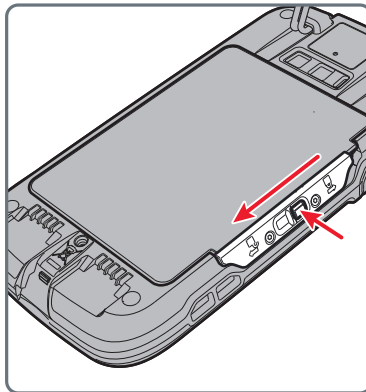

- 7 Lift up on the edge of the battery and remove it from the computer.

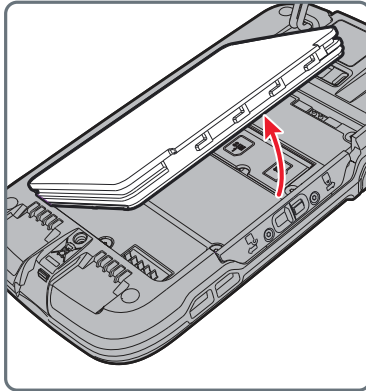





- 8 Insert the charged battery into the computer.
- 9 Press in on the battery door and slide it into the locked position.

About the Battery Status Icon

Use the battery icon in the Status bar to see the power status of your battery. The table below only includes some of the icons. If you want more detailed information on your battery, such as usage time or charge remaining on the battery, go to **Settings > Battery**.

Battery Status Icons

Icon	Status
	The battery charge is at 100%.
	The battery charge is at 50%.
	The battery is critically low. You need to replace the battery now.
	The computer is connected to external power and the battery is charging.
	There is a battery error. Install another battery. If the problem persists, call Honeywell Technical Support.

The Battery status LED in the upper right corner of the computer indicates the charging status of the battery. You can also use the Battery status LED as a notification LED. For more information on how to use the LED as a notification LED, see <http://developer.android.com/guide/topics/ui/notifiers/notifications.html>.

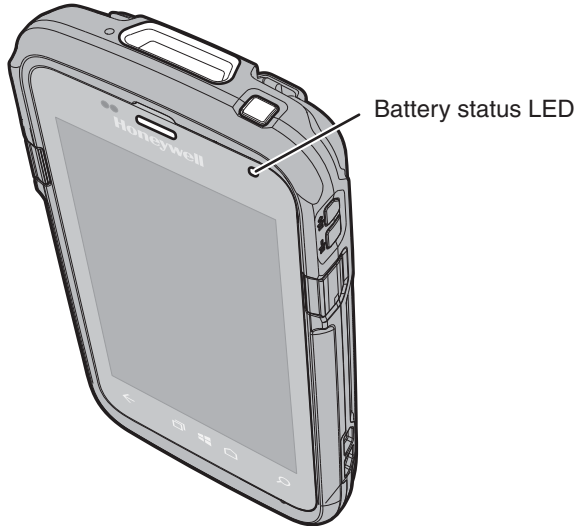

Out-of-Box Battery Status LED Descriptions

Connected to Power	LED State	Description
No	Blinking amber	Battery level is below 20%
No	Off	Battery level is more than 20%
Yes	Steady amber	Battery level is between 0% and 60%
Yes	Blinking green	Battery level is between 60% and 95%
Yes	Steady green	Battery level is above 95%
Either	Blinking red	Battery error

Change the Battery Status LED Behavior

You can change the behavior of the Battery status LED if the default behavior for a charging battery (blinking green) is not acceptable to your environment.

In addition to the out-of-box Battery status LED behavior, you can choose:

- Default Battery LED
- No Battery LED

Use the Default Battery LED setting if you want the status LED to turn on steady amber and then steady green when charging. Select the **No battery LED** setting if you want to use the LED as a notification LED for applications or device management solutions.

Default Battery LED Descriptions

Connected to Power	LED State	Description
No	Blinking red	Battery level is below 15%
No	Off	Battery level is 15% or more
Yes	Steady red	Battery level is below 15%
Yes	Steady amber	Battery level is between 15% and 90%
Yes	Steady green	Battery level is 90% or more

1 Tap **All Apps** > **Settings** > **Battery LED**.

2 Select one of these options:

- Default Battery LED
- HSM Battery LED (Out-of-Box setting)
- No Battery LED

Check the Battery Level

In addition to the Battery status icons and the Battery status LED, you can get the battery status from the Settings app.

- 1 Tap **All Apps > Settings**.
- 2 Tap **Battery**. The current percentage of battery power remaining and the amount of usage time left on the battery appear on the screen. A list shows the battery usage for individual apps and services.

For usage details, tap one of the apps or services in the list.

About Battery Life and Conservation

If you store the batteries outside of the computer for long periods of time, they slowly discharge. Honeywell recommends storing the battery in a charger to maintain battery performance.

Battery Conservation Tips

When You Want to:	Do this to Save Battery Power:
Use the computer and the low battery status icon appears or the battery light turns on.	Press and hold the Power button and then select Power off from the menu. After the computer turns off, remove the battery and insert a fully charged battery.
Stop using the computer for 5 minutes or more.	Make sure that the low battery status icon is not on the screen and that the battery status LED is not on. Press the Power button to suspend the computer.
Store the computer for more than a day.	<ul style="list-style-type: none">• If you are storing the computer for a few days (such as over the weekend), install a charged battery or connect the computer to a power source.• If you are storing the computer for a longer period of time, remove and charge the battery. When the battery is done charging, store both the battery and the computer in a cool location.• If you store the battery for several months, recharge the battery periodically to keep it at peak performance.
Store the battery outside of the computer.	Store the batteries in a charger.

Battery Recommendations and Safety Precautions

- Charge the battery before use. Battery ships with a partial charge only.
- See “**Charge the Battery**” on page 6 for approved charging methods. Use of this battery in other devices could result in damage to the device or battery.
- Avoid dropping the battery or computer. If you suspect that the battery or computer is damaged, send it to Honeywell service center for inspection.
- Replace this battery only with another model CT50-BTSC battery. These batteries have been tested in accordance with applicable safety standards. Contact your Honeywell sales representative or distributor if this battery is no longer available.
- Discarded batteries may create a safety hazard. Before disposal, cover the battery contacts with electrical insulating tape.
- Do not modify the battery or attempt to insert foreign objects into it.
- Do not solder directly to the battery contacts.
- Do not short circuit the battery, and keep it away from metallic items.
- Do not drop the battery or apply mechanical shocks or pressure to it.
- Do not disassemble or open, crush, bend or deform, puncture, shred or burn the battery.
- Do not immerse the battery in water or get the battery wet.

Enable Airplane Mode

If you do not need to connect to any wireless networks, you can enable Airplane mode to turn off all the radios and save battery power.

- 1 Tap the Settings app.
- 2 In the Wireless & Networks section, tap **More**.
- 3 Select the **Airplane mode** check box to enable it.

Power On the Computer

The first time you power on the computer, a Welcome screen appears. Follow the prompts on the Welcome screen as the setup wizard helps you:

- set the default language.
- set up the Wi-Fi network connections.
- set the time, date, and time zone.
- personalize (name) the computer.

After you have fully charged and installed a battery, power on the computer for the first time:

- Press and release the **Power** button.



Note: Once you complete the Setup Wizard, the Welcome screen no longer appears when you power on the computer. You will now see the Lock screen each time you power it on.

Unlock the Screen

Every time you power on the computer, you will need to unlock it.

- Drag the lock toward any edge of the screen to unlock it.

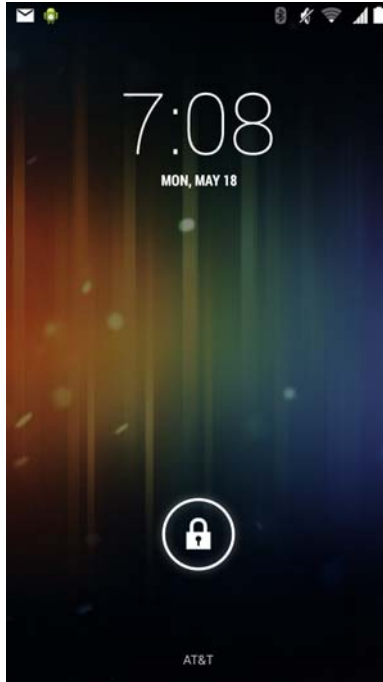

After you start using the computer, you should set a password to protect the computer. Tap **All Apps** > **Settings** > **Security**.

About the Good Read LED

The Good Read LED indicates the status of the scanner. For more information on how to scan bar codes, see [“Scan a Bar Code” on page 44](#).

Good Read LED



Good Read LED Descriptions

LED Color	Description
Green	Good read of a bar code.
Blinking green	The data collection engine is processing or starting up.

Configure the Screen Backlight

The display has an ambient light sensor that automatically adjusts the backlight intensity to conserve power and ensure the display is readable. You can set the backlight intensity level as needed for your environment.

- 1 Tap the Settings app.
- 2 Tap **Display > Brightness**.
- 3 Tap AUTO to use the ambient light sensor to automatically adjust the brightness for your work environment.
Or, adjust the slider to set the brightness level.

About the Audio Features

The computer has a speaker, a microphone, and several software tools for configuring the sound volumes.

Adjust Ringtone and Notification Volume

You can quickly adjust the volume of ringtone and notification sounds by using the side volume buttons.



Note: This method of adjusting the volume only affects the volume of ringtone and notification sounds. To change the volume for other sounds, open the Settings app and tap **Sound > Volumes**.

Chapter 1 — About the Computer Features

- 1 Press one of the buttons on the right side of the computer. The Volume slider appears.

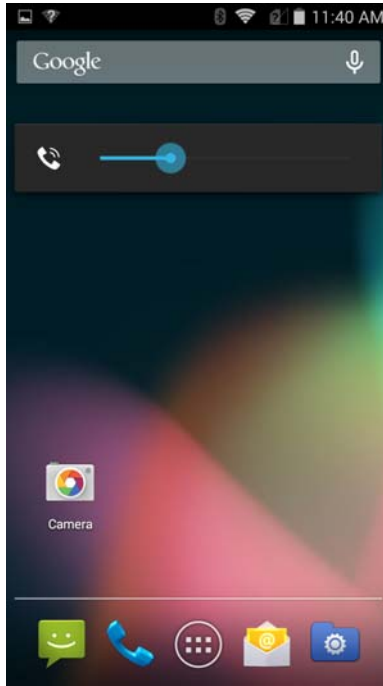



- 2 Press the buttons or adjust the slider to change the volume.

Enable Vibrate Mode

You can switch to Vibrate mode and disable the speaker if necessary for your working environment.

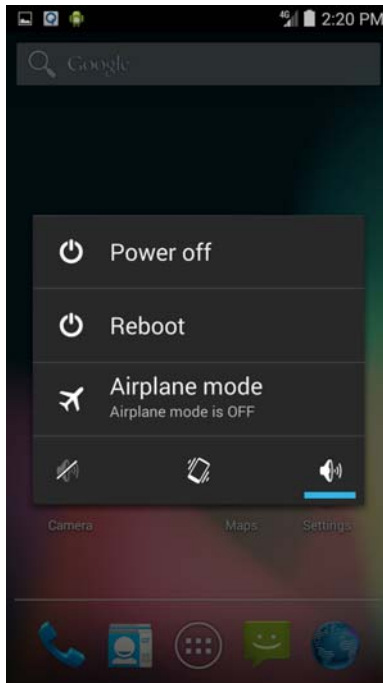
- 1 Press and hold the Power button. The power options screen appears.



- 2 Tap  to turn on Vibrate mode.

Audio Settings

This section describes the audio and sound settings you can configure in the Settings app. To change audio settings, start the Settings app and tap **Sound**.

Audio and Sound Settings

Setting	Description
Volumes	Use the sliders to set the volume for: <ul style="list-style-type: none">• music, video, games, and other media.• ringtone and notifications. You can also use the side volume buttons to change the volume.• alarms.
Phone ringtone	Select a ringtone.
Vibrate when ringing	Select to enable vibrate mode when the phone is ringing.
Default notification sound	Select a notification sound.
Dial pad touch tones	Select to enable audio tones when you use the phone keypad.
Touch sounds	Select to enable audio sounds when you use the touch screen.
Screen lock sound	Select to enable an audio tone when the screen is locked.
Vibrate on touch	Select to enable vibrate mode when you touch the screen.

Insert a microSD Card

You can use a microSD card to increase file storage capacity or to install software. Honeywell recommends the use of Single Level Cell (SLC) industrial grade microSD or microSDHC memory cards with the computer for maximum performance and durability.



Note: Format the memory card before initial use.

- 1 Power off the computer.
- 2 Disconnect the handstrap from the bottom of the computer. If you have a CT50h, you do not have a handstrap.

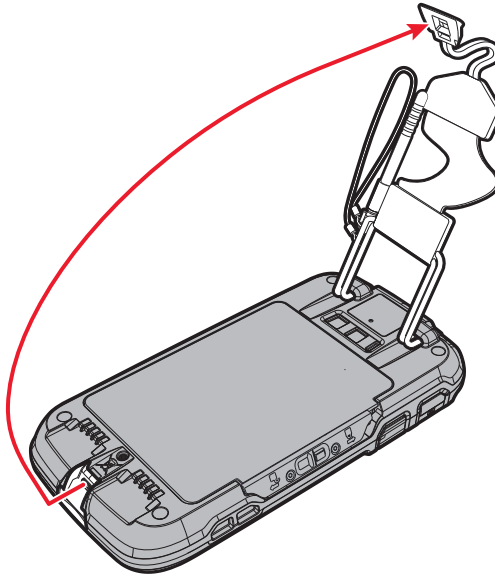

- 3 Press and slide the battery door toward the bottom of the computer to unlock the door.

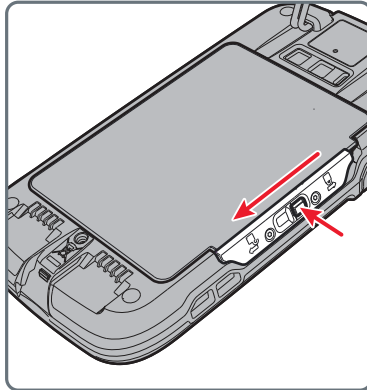

- 4 Lift up on the edge of the battery and remove it from the computer.
- 5 Press down on the SD card door and slide it toward the top of the computer to open it.

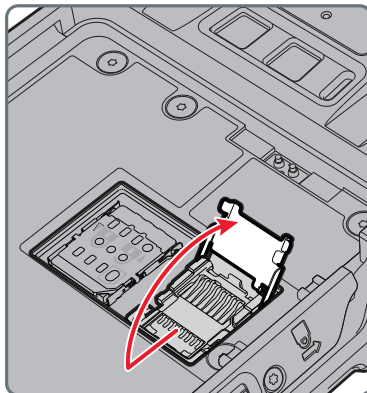

- 6 Insert the microSD card into the door.

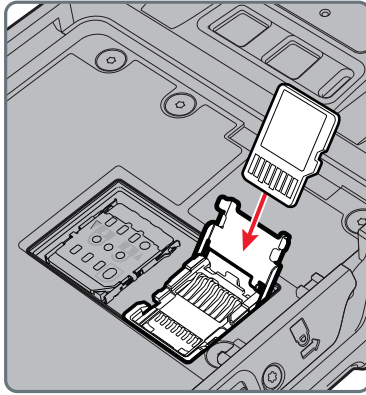

- 7 Press down on the SD card door and slide the door toward the bottom of the computer to lock it.
- 8 Insert the battery into the computer.
- 9 Press in on the battery door and slide it into the locked position.
- 10 Replace the handstrap.

How to Transfer Files

You can transfer files between your desktop PC and the computer with the HomeBase or USB adapter and a standard USB cable. When the computer is connected through USB, you can browse to it and drag-and-drop to move files back and forth to a Windows PC. If you are transferring files to and from a Mac, use the Android File Transfer application (available from www.android.com/filetransfer).

By default, the computer connects using MTP (Media Transfer Protocol). If you are transferring mainly camera images, you can configure the connection to use PTP (Picture Transfer Protocol). If your Windows PC does not support MTP, you may be able to transfer files using PTP instead.



Note: The computer supports Hi-Speed USB communications (USB 2.0) with a maximum data transfer rate of 480 Mbps.

- 1 Connect the computer to your PC.
- 2 On the computer, select either **Connected as a media device (MTP)** or **Camera (PTP)**. The mobile computer stores your selection as the default.
- 3 Browse to the mobile computer from your PC. You can now copy, delete, or move files between the computer and your PC.

How to Browse Files on the Computer

You can use the File Browser application in Power Tools to browse the files on the computer and the microSD card.



Note: Due to system permissions, some files cannot be opened. Depending on the associated application, a choice of applications may be available to open the file.

- 1 Touch **All Apps** > **Power Tools**  > **File Browser** .
- 2 Touch a folder name or file name to open it.

Accessories for the Computer

The CT50 and CT50h ship with a battery. All other accessories are ordered and shipped separately. For help, contact your local sales representative.

CT50 Accessories and Descriptions

Accessory	Description
CT50 Battery (Model CT50-BTSC)	The battery provides hours of power to the computer. You may want to purchase spare battery packs for longer shifts.
eHomeBase (Model CT50-EB)	Use the eHomeBase to hold a computer with a battery installed, charge a spare battery pack, charge the main battery pack, and provide power to the mobile computer. The eHomeBase has a USB client connector as well as an Ethernet connector.
HomeBase (Model CT50-HB)	Use the HomeBase to hold a computer with a battery installed, charge a spare battery pack, charge the main battery pack, and provide power to the mobile computer. The HomeBase has a USB client connector.
ChargeBase (Model CT50-CB)	The ChargeBase is a 4-slot charging cradle that can power four computers, and charge their main batteries in 6 hours.
NetBase (Model CT50-NB)	The NetBase enables up to four computers to communicate with a host device over an Ethernet network. The Net Base also provides a second RJ45 Ethernet port for connection to an additional device such as a printer, workstation, or another Net Base.
Vehicle Power Adapter (Model CT50-MC) (Not supported for CT50h)	Use the vehicle power adapter to charge the battery installed in the computer from the accessory port in your vehicle.
Vehicle Dock (Model CT50-MB) (Not supported for CT50h)	Use the vehicle docks to hold and charge the computer while using it on a vehicle. The vehicle dock also contains a USB host port.
Quad Charger (Model CT50-QBC)	Use the quad charger to charge up to four batteries.

CT50 Accessories and Descriptions

Accessory	Description
USB Adapter (Model CT50-USB)	Use this snap-on adapter to connect to a USB port for transferring data or charging your computer.
Scan Handle (Not supported for CT50h)	Attach to a computer to have an easy way to grip the it and scan labels.
Holster (Not supported for CT50h)	Use the holster to carry the computer hands-free in the work environment. You can choose between three different holsters.
Belt Clip	Use the belt clip to carry the computer attached to your belt.

2

About the User Interface and Applications

Use this chapter to learn about the Android user interface and how to interact with the screen. You can also use this chapter to learn about the Honeywell applications on the computer.

About the User Interface

The Android 4.4 operating system provides a touch-friendly and easy-to-navigate user interface.

About the Home Screen

When you turn on the mobile computer, the Home screen is the first screen that appears after language provisioning is complete.

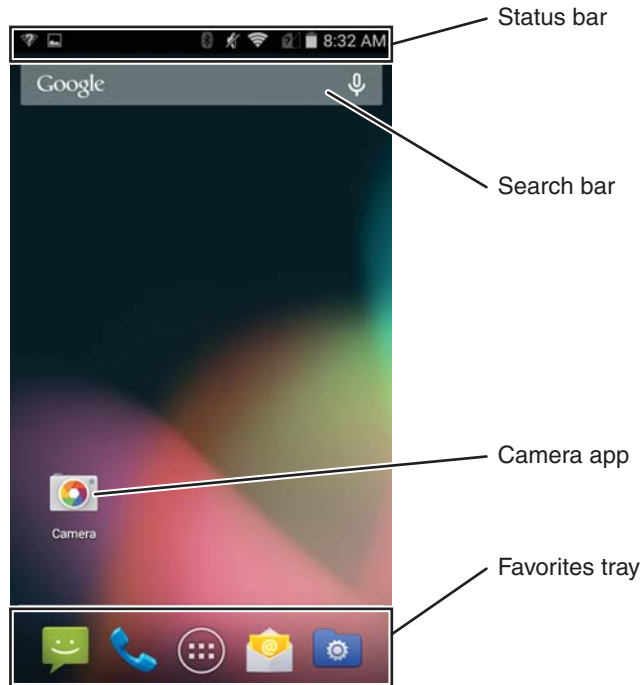





Understand the Home Screen

Item	Description
Status bar	Status icons to the left tell you when an app has sent notifications, such as an arriving message. System icons to the right display the current wireless and network connection state and battery level.
Favorites tray	App icons in the tray are visible on the Home screen. The All Apps icon is in the center of the Favorites tray.
Search bar	Search the internet or the computer using Google.

Navigation and Function Buttons

There are navigation and function buttons below the Favorites tray on the front panel of the computer.



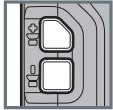



Navigation and Function Buttons

Button	Description	Function
	Back	Takes you back to the previous screen.
	Recent Apps	Lets you view and switch between recently used apps.
	Home	Returns you to the Home screen
	Search	Starts a search on the computer or the internet.
	Volume	Raises or lowers the volume of the speaker.















About Status Bar Icons

Status and notification icons show you the current status of your network, the battery, notifications, and sounds. Use this table to understand some of the available status icons.

Status and Notification Icons

Icon	Description	Icon	Description
	Pending calendar event		Sound is turned off
	Pending alarm and Alarm is set		Vibrate mode is turned on
	New text message or multimedia message		Battery charge is at 100%

Status and Notification Icons (continued)

Icon	Description	Icon	Description
	Error with text or multimedia message delivery		Computer is connected to external power and the battery is charging
	New email		Airplane mode is turned on
	Computer is connected to a PC with a USB cable		Computer is paired with a Bluetooth device
	ABD active (USB debugging enabled)		Bluetooth is turned on
	Synchronizing data		Wi-Fi network connected with full signal strength
	Error with sync or sign-in		Wi-Fi network connected but no signal strength
	SD card is full		Ethernet status connected

Remap a Button

You can change the default function of the Left Scan, Right Scan, or Camera buttons.

- 1 Tap **All Apps > Settings > Key remap**.
- 2 Touch to button you want to remap.
- 3 Tap **KEYS** or **APP** to view the available functions.
- 4 Select the function you want to assign to the button. The function you selected now appears under the button name.

View Notifications

You can view the notifications shade to see a list of events on the computer.

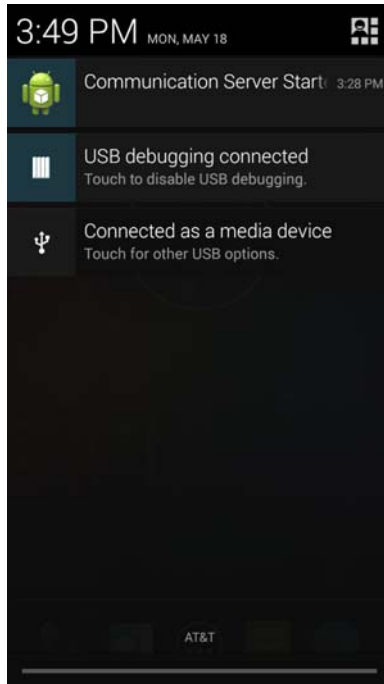

- To open the shade, swipe down from the top of the screen.
- To close the shade, swipe up from the bottom of the screen, or tap the Back or Home buttons.

Manage Notifications

When an app sends a notification to the computer, you can easily respond to it.

- 1 When a notification icon appears, swipe down from the top of the screen.
- 2 To respond to a notification, touch it. The associated app opens so that you can respond.
 - To dismiss a notification, swipe it sideways.
 - To dismiss all notifications, tap  in the top right corner.

Customize the Home Screen

You can add application icons to any Home screen to access them more easily.

- 1 Touch . The All Apps screen appears.
- 2 To add an app icon to a Home screen, touch and hold the icon for the app, and then slide your finger to place the icon on one of the Home screens.

To add a widget icon to a Home screen, touch **WIDGETS** at the top of the screen, touch and hold the icon for the widget, and then slide your finger to place the widget icon on one of the Home screens.

- 3 To remove an app or widget from the Home screen, touch and hold the icon and slide it over **Remove** at the top of the screen.

Customize the Favorites Tray

You can add application icons to the Favorites tray to access them more easily.

- 1 Touch . The All Apps screen appears.
- 2 Touch and hold an icon in the Favorites tray, and slide it over **X Remove** at the top of the screen.
- 3 To add an app icon to the Favorites tray, touch and hold the icon for the app, and then slide your finger to place the icon in the Favorites tray.

To add a Widget icon to the Favorites tray, touch **WIDGETS** at the top of the All Apps screen, touch and hold the icon for the widget, and then slide your finger to place the icon in the Favorites tray.

Use Google™ Search

Use the Google Search field at the top of the Home screen to help you find anything you need on the computer or on the web.

- 1 At the top of any Home screen, touch **Google** to type your search term. As you type, suggestions from Google web search appear below the Search box, and results from the computer (such as apps or contacts) appear below the web search results.
- 2 Tap a suggestion to search for it immediately, or touch its arrow just to add the term to the search field without starting to search.

About Screen Gestures

Use your fingers or the stylus to manipulate icons, buttons, menus, the onscreen keyboard, and other items on the screen.

- To select or activate something, tap it.
- To type something, such as a name or password, touch where you want to type. A keyboard appears that lets you type into the field.

Other common gestures include:

- **Touch and hold:** Touch and hold an item by touching it and lifting your finger until an action occurs.
- **Drag:** Touch and hold an item for a moment. Without lifting your finger, move your finger on the screen until you reach the target position. For example, you can drag to reposition shortcuts on the Home screen.
- **Swipe or slide:** Quickly move your finger across the screen, without pausing when you first touch. For example, you can slide a Home screen left or right to view the other Home screens.
- **Double-tap:** Tap quickly twice on a web page, map, or other screen to zoom in. Double-tap again to zoom out.
- **Pinch:** In some apps, you can zoom in and out by placing two fingers on the screen at once and pinching them together (to zoom out) or spreading them apart (to zoom in).

Set the Time Zone









The computer gets the current date and time from its network connection. You can manually set the time zone for your location.

- 1 Start the Settings app.
- 2 Tap **Date & time**.
- 3 Clear the check box for **Automatic time zone**.
- 4 Tap **Select time zone** and select the time zone for your location.









About Honeywell Applications

Honeywell applications help you troubleshoot and connect your computer to other devices and networks. Many of the applications in this table are located in the Power Tools folder. For more information on Power Tools, look for Dolphin Power Tools on www.honeywellaidc.com.

Honeywell Applications Available on the Computer

Icon	Application	Description
	AppsConfig	Provides a way to disable/enable apps and uninstall updates.
	AutoInstall Settings	Use to automatically install packages, APKs, and configure during the boot sequence.
	Configure Autorun	Configure which applications you want to run during the boot sequence.
	Backup	Backup and restore settings and user data.
	BattMon	Monitor the charge status of the battery.
	Demo	Use ScanDemo to demonstrate how the scanner works. You can use it to scan a bar code, set the symbologies it scans, and determine the computer response to a scanned bar code.
	Diagnostic Information	Use the DiagnosticInfo app to view device information, Honeywell Apps, Radio Information, Battery Information, Memory Information, and Scanner Information.
	EZConfig	Configure device and applications efficiently with bar code and configuration files.
	EZConfig Editor	View and edit the configuration(.xml) files and update settings.

Honeywell Applications Available on the Computer

Icon	Application	Description
	EZConfig Utils	Displays a list of the .xml files for apps that you can edit on the computer.
	File Browser	Provides an efficient way to browse files on the computer.
	IPConfig	Use IPConfig to view network adapter information.
	LogView	Displays LogCat and Dmesg information in real time.
	Ping	Use Ping to verify communication links or to make sure a specific IP address is working.
	Route	Use Route to view and edit the rules that govern how packets destined for various subnets are routed.
	Wi-Fi Info	Provides Wi-Fi information on the computer.
	Wi-Fi Radio Settings	Provides an easy way to configure Wi-Fi settings on the computer

Download Honeywell Launcher

Honeywell Launcher is an Android application, designed for Honeywell mobile computers, that provides a platform from which other applications may be launched while attempting to provide a locked-down environment. You can configure Honeywell Launcher for your specific application requirements. You can download and use Honeywell Launcher for a 60-day evaluation period. After the evaluation period expires, you will need to purchase a license. For more information on Honeywell Launcher, see the *Launcher for Android User Guide* available for download from www.honeywellaidc.com.

Unlock Developer Options

If you are a developer working with the computer, you can easily unlock the Developer options. The Developer options allow you to easily test and debug applications under development for the computer. After you unlock the developer options, a link to Developer options appears in the System menu.

- 1 Start the Settings app.
- 2 Tap **About phone**.
- 3 Tap **Build number** seven times. A popup message appears informing you that you are now a developer.

3

About the Scanner

Use this chapter to understand how to scan bar codes and how to configure the scanner.

About the Scanner

The internal scanner can read 1D and 2D bar code symbologies, composite symbologies, and postal codes. It also supports omnidirectional scanning for greater flexibility in real-world settings. The image engine can also capture black and white images, such as signatures and pictures of damaged inventory.

How to Scan Bar Codes as Keyboard Input

The scan wedge feature sends scanned bar code data to an active application as Android keypad input. To scan a bar code as keyboard input, open an application that accepts text input and then scan a bar code. By default, scan wedging is enabled on the computer.

You can use applications that are coded to use the scanner or applications that receive data through the scan wedge feature. If an application claims the scanner through the BarcodeReader API, the scan wedge feature is temporarily disabled. You can find information on how to create custom applications for the computer in the *Software Development Kit (SDK)* available for download at www.honeywellaidc.com.

Change the Scanner Settings

Changes you make to the Default profile apply to all applications with no profile.

- 1 Tap the Settings app.
- 2 Tap **Scanning**.
- 3 Tap **Default**.
- 4 Select Data Processing Settings, Symbology Settings, Decode Settings, Imager Settings, Trigger Settings, or Notification Settings.
- 5 Modify the settings to meet your application needs.

Restore Default Scanner Settings

You can easily discard all changes you made to the Default profile and restore the default values.



Note: When you select to restore the default values of one of the settings, it also restores the default values of all settings within the profile.

- 1 Tap  in the upper right corner of any of the scan settings screens.
- 2 Tap **Restore all defaults**.

Scanners Default Settings

Use these tables to understand the Data Processing Settings, Symbology Settings, Imager Settings, Trigger Settings, and Notification Settings.

Data Processing Settings

Use the Data Processing Settings to specify how bar code data is processed by the computer.

Data Processing Settings

Setting	Description	Default
Wedge	Enable or disable sending the bar code data as Android KeyEvents when sending data to the active application.	Enabled
Charset	Select the character set to use when interpreting the bar code data into a string. Options include: <ul style="list-style-type: none"> • ISO-8859-1 • US-ASCII • UTF-16 • UTF-16BE • UTF-16LE • UTF-8 Corresponds to BarcodeReader property: PROPERTY_DATA_PROCESSOR_CHARSET	ISO-8859-1
Prefix	Defines the string added before the decoded bar code data. Substitutions occur within the Prefix string values as follows: <ul style="list-style-type: none"> • \r is replaced by 13 • \n is replaced by 10 • \t is replaced by 9 • \\ is replaced by “\” 	None

Data Processing Settings (continued)

Setting	Description	Default
Suffix	<p>Defines the string added after the decoded bar code data. Substitutions occur within the Suffix string values as follows:</p> <ul style="list-style-type: none"> • \r or \x0A is replaced by 13 • \n is replaced by 10 • \t or \x09 is replaced by 9 • \\ is replaced by '\' 	None
Data Editing Plugin	Specify a Total Freedom data editing plug-in.	None
Symbology Prefix	<p>Specify a symbology identifier prefix to the bar code data. Options include:</p> <ul style="list-style-type: none"> • None • Honeywell • AIM 	None
Launch Browser	<p>Enable or disable URL bar code handling. If a bar code starts with http:// or https://, the browser opens using the bar code data as a URL.</p> <p>Corresponds to BarcodeReader property: PROPERTY_DATA_PROCESSOR_LAUNCH-BROWSER</p>	Enable
Scan to Intent	<p>Enable or disable special handling of scan-to-intent bar codes. Applies to bar codes in one of the following formats:</p> <p>'/' ACTION</p> <p>'/' ACTION '\$' extra-data</p> <p>Where:</p> <p>ACTION and extra-data are any string of characters. Launches an application listening for the intent:</p> <p>Intent action: "com.honeywell.scantointent.intent.action." + ACTION</p> <p>Intent extra "com.honeywell.scantointent.intent.extra.DATA" contains the remainder of the bar code data after the first '\$' character.</p> <p>Corresponds to BarcodeReader property: PROPERTY_DATA_PROCESSOR_SCAN_TO_INTENT</p>	Enabled

Data Processing Settings (continued)

Setting	Description	Default
Launch EZ Config	Enable or disable special handling of EZConfig bar codes. Applies to EZConfig bar codes, which are encoded with the Aztec symbology and containing specific header data. Corresponds to BarcodeReader property: PROPERTY_DATA_PROCESSOR_LAUNCH_EZ_CONFIG	Enabled

Symbology Settings

Use the Symbology Settings to enable and disable bar code symbologies. Tap a symbology to view and modify the symbology configuration parameters.

Symbology Settings

Setting	Default
Code 128	Enabled
GS1-128	Enabled
Code 39	Enabled
Datamatrix	Enabled
UPC-A	Enabled
UPC-E	Disabled
EAN-8	Disabled
EAN-13	Enabled
Aztec	Enabled
China Post	Disabled
Codabar	Enabled
Codablock A	Disabled
Codablock F	Disabled
Code 11	Disabled
Code 93	Disabled
Composite	Disabled
Han Xin	Disabled
IATA 2 of 5	Disabled

Symbology Settings (continued)

Setting	Default
Interleaved 2 of 5	Enabled
Korean Post	Disabled
Matrix 2 of 5	Disabled
Maxicode	Disabled
Micro PDF 417	Disabled
MSI	Disabled
PDF 417	Disabled
QR Code	Disabled
RSS (GS1)	Disabled
Standard 2 of 5	Disabled
Telepen	Disabled
TLC 39	Disabled
Trioptic	Disabled
2D Postal Settings	Disabled
OCR	Disabled

Decode Settings

Use the Decode Settings to scan bar codes that are densely packed. When enabled, the scanner will only decode a bar code is part of it is at the center of the aimer. Although you can adjust the Window dimensions, Honeywell recommends leaving the settings at 50 to define the “center” area for the bar code.

Decode Settings

Setting	Description	Default
Center Decode	Enables the ability for the scanner to scan only the bar code at the center of the aimer.	Disabled

Imager Settings

You should not need to modify the Imager Settings. The Override Recommended Values setting is disabled by default. The recommended Imager Settings are designed to work in a wide range of environments and should only be modified if you have an advanced understanding of imagers.

Trigger Settings

Use the Trigger Settings to configure how the scan buttons work.

Trigger Settings

Setting	Description	Default
Decode Timeout	Scanning automatically turns off after this number of seconds if the scan trigger is pressed and nothing has successfully decoded.	20

Notification Settings

Use the Notification Settings to configure how your computer responds when you scan a bar code.

Notification Settings

Setting	Description	Default
Good Read Notification	Enables or disables a good read notification. The notification consists of a green blink of the Good Read LED, a short beep, and an optional short vibration.	Enabled
Bad Read Notification	Enables or disables notification of a failed scan. The notification consists of a red blink of the Good Read LED, an error beep, and an optional short vibration.	Disabled
Vibrate Enabled	Enables or disables whether the computer vibrates when there is a good or bad read.	Disabled

Scan a Bar Code

The scanner has an aiming beam to help you correctly frame bar codes. It also supports omni-directional (360°) scanning to make it easier for you to scan bar codes.



Note: Before you start scanning bar codes, use the Settings app to enable only the bar code symbologies that you need.

- 1 Tap **All Apps** > **Demos** > **ScanDemo**.
- 2 Point the scanner window at the bar code and hold the computer steady a few inches from the label.
- 3 Press one of the **Scan** buttons or press **Scan** on the touch screen. Make sure the entire bar code is inside of the illumination frame.

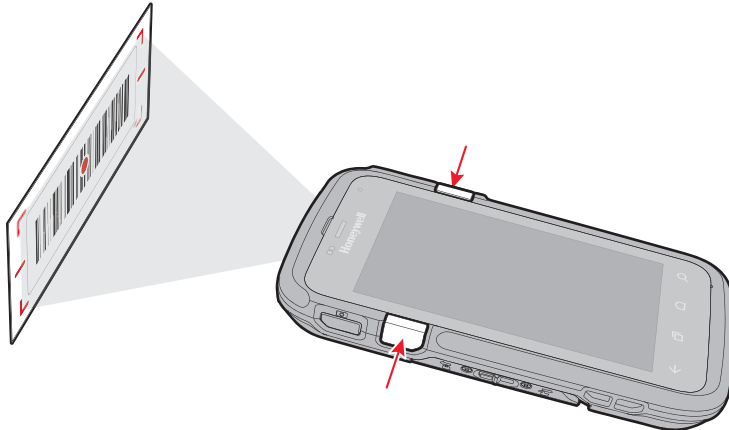

When the scanner successfully reads a bar code, you hear a high beep and the Good Read LED turns on briefly.

4

Use the Phone

You can use the phone feature to make and receive phone calls as well as transmit data through wireless wide-area networks (WWANs).

The WWAN radio is not supported on the Dolphin CT50h Healthcare Mobile Computer. The CT50h supports voice calls and texting through VOIP application software provided by third-party software vendors.

About the Phone

Phone features on the computer include a speaker and a microphone. You can also use a Bluetooth headset or hands-free kit. The phone feature is enabled by default.

The WWAN radio in your computer determines the supported network types:

- If your computer includes the UMTS/HSPA+ WAN radio, you can connect to UMTS networks.
- If your computer includes the Flexible Network Radio, you can connect to CDMA or UMTS networks in all regions that support these technologies. The Flexible Network Radio is a software-defined radio (SDR) that can be configured for CDMA or UMTS depending on your wireless communication needs.

Honeywell supports Verizon in the United States (only) as a CDMA network carrier. For other carriers, contact Honeywell Technical Support.

After you turn on the phone and activate service with your wireless carrier, you can customize the phone features and network settings in the Wireless & Networks section of the Settings app.



Note: Both WWAN radios support Network Information and Time Zone (NITZ) messages to automatically set the system time.

Activate the UMTS Phone

Activating the UMTS phone (Model CT50LUN) on your CT50 is done the same way whether your computer has the Flexible Network Radio or the UMTS/HSPA+WAN radio.

You use a SIM card to activate the UMTS phone on the CT50. You can purchase the SIM card from your network provider.

- 1 Power off the computer.
- 2 Disconnect the handstrap from the bottom of the computer.
- 3 Press and slide the battery door toward the bottom of the computer to unlock the door.
- 4 Lift up on the edge of the battery and remove it from the computer.

- 5 Lift up on the SIM and MicroSD door.

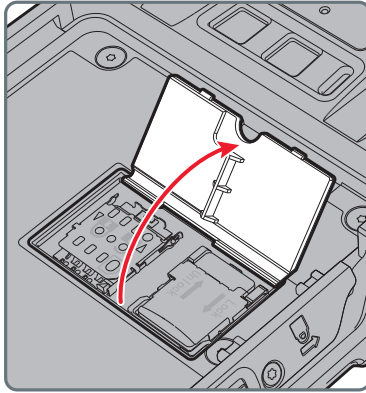

- 6 Press down and slide the SIM door toward the top of the computer to open it.

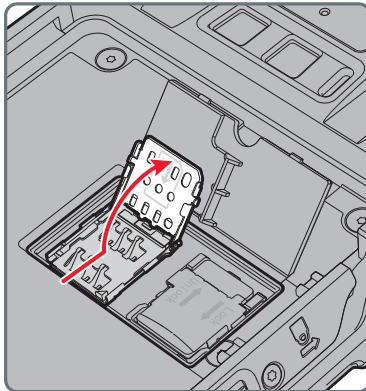

- 7 Insert the SIM card in the door.

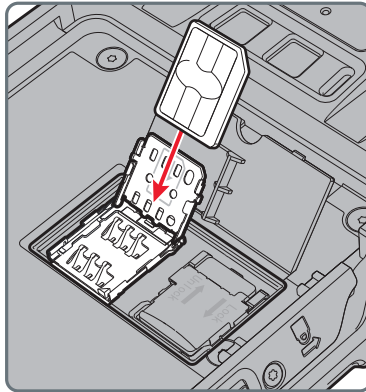

- 8 Close the SIM card door and slide it toward the bottom of the computer to secure it.

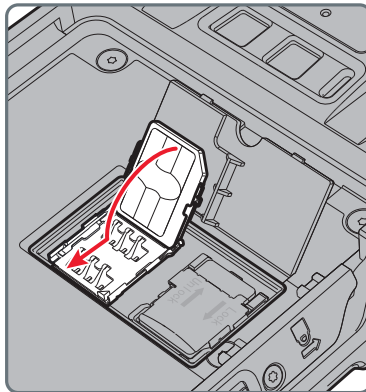

- 9 Replace the battery, reconnect the handstrap, and press the Power button to turn on the computer. The phone is now ready to use.

Activate the CDMA Phone

To activate the CDMA phone (Model CT50LFN) in your mobile computer, you need to contact your wireless carrier and set up an account.



You also need to provide the carrier with the Mobile Equipment Identifier (MEID) for the computer. You can find the MEID:

- on a label located in the battery compartment.
- on the outside of the computer shipping box.



Note: For the CDMA phone, settings are permanently stored in the WWAN radio after activation. CDMA settings persist through a factory data reset.



The activation process is slightly different for each CDMA carrier. Your carrier sales contact and an Honeywell representative can guide you through the process. In general, you activate the CDMA phone as follows:

- 1 Contact your wireless provider and give the provider the MEID for the computer.
- 2 If your carrier is Verizon, tap , enter *228 on the phone keypad, and tap . After a short wait, a message appears, confirming either success or failure of the activation. After successful activation, the phone is ready to use.

Make a Phone Call

Once the phone is activated, you can make a phone call.



- 1 On the Home or All Apps screen, tap .

If the Phone app opens to a list of numbers instead of the keypad, swipe left or touch  to return to the keypad.
- 2 Touch the keys to enter the number, and then touch  below the keypad to dial.
- 3 To end a call in progress, tap .

Answer the Phone

When you receive a phone call, the Incoming Call screen opens, showing the caller ID. All incoming calls are recorded in the Call log. If you miss a call, you receive a notification.

When a call arrives, touch the white phone icon and slide over one of the icons:

- To answer the call: 
- To send the call to voicemail: 
- To send a message from a list of default text messages: 

Switch Apps During a Phone Call

You can switch apps while a phone call is in progress. For example, you can use the People app to look up contact information during your call.



Note: If you have only a WWAN connections, apps that need a data connection may be unable to access online data while the phone call is in progress. If simultaneous phone calls and stat connections are not possible due to provider limitations, voice calls receive priority. Check with your provider for more information.

- During a phone call, tap another app icon on the Home or All Apps screen to run that application. The green Phone icon appears in the Status bar while the call is underway.

Check Your Voicemail

When you have a new voicemail message, the voicemail icon appears at the top left of the screen.



Note: Consult your service provider for more information on setting up your voicemail account.



- 1 Swipe down from the top of the screen to view your notifications. The voicemail notification shows the number of unread messages and a number to dial.
- 2 Touch **New voicemail**. The phone dials the number. Follow the instructions to retrieve your messages.

Set Your Voicemail Number



To access your voicemail, you must set your voicemail number in the Phone app.



Note: This procedure does not apply if you are a Verizon customer.

- 1 Tap .
- 2 Tap  and then tap **Settings**. A list of call settings appears.
- 3 Tap **Voicemail > Setup > Voicemail number**.
If you are an AT&T customer, enter your voicemail number.
- 4 Tap **OK**.

Change Voicemail Settings



- 1 Tap  on a Home or All Apps screen.
- 2 Tap  and then tap **Settings**.
- 3 Tap the voicemail setting you want to change.

Make an Emergency Phone Call

You can use the phone to make an emergency phone call, even if the SIM card is missing from your UMTS phone or if you do not have a valid CDMA account. In either case, the phone shows that you have no service. However, if you dial certain emergency numbers (such as 112, 911, 000, 08, 118, 119, or 999) the call will go through.

Configure Phone Settings

You can customize settings for the phone, including the ringtone, voicemail options, keypad tones, internet call settings, and other options.

- 1 Tap .
- 2 Tap  and then tap **Settings**. The Call settings menu appears.
- 3 Change phone settings as necessary.

5

Use the Camera

Use this chapter to learn how to take pictures and record videos with the color camera.

About the Color Camera

The computer contains an 8-megapixel color camera for taking pictures and videos. The camera and flash are located on the back of the computer.

Use the Gallery app  to view photos and videos stored on the computer.

Adjust the Camera and Video Settings

The camera and video settings are adjustable from within the **Camera** app.

How to Zoom

The camera zoom is controlled using a pinching motion on the touch screen. Place two fingers on the screen at the same time, and then:

- spread them apart to zoom in (enlarge and object).
- pinch them together to zoom out.

Change Camera Settings

You can change the camera settings for best results when taking pictures.

- 1 Press the **Camera** button or tap All Apps and then tap Camera .
- 2 Tap **•••** to view the options for the camera.
- 3 Tap HDR or one of the icons to change basic camera settings.
 - When HDR is enabled, the computer automatically captures multiple photos and combines them into one photo creating the best quality image possible.
 - Enable or disable different options such as scene mode, store location, and picture size.





Take a Photo

- 1 Press the **Camera** button or tap All Apps and then tap Camera .
- 2 Using the screen as a viewfinder, move the computer until you see the image you want to capture.

- 3 Tap the screen to set the focus. By default, the camera senses the lighting in the environment and turns the torch on if needed.
- 4 Press the Camera button or tap  to take a photo.
 - To view the picture, swipe the screen to the left.
 - To return to the Camera app, swipe the screen to the right.



Record a Video

This section explains how to record video with the camera in the computer.

- 1 Press the **Camera** button or tap All Apps and then tap Camera .
- 2 Swipe the screen to the right until the camera options appear in the left column.
- 3 Tap  to select video.
- 4 Tap  to begin recording video. To zoom in or out, drag the slider at the bottom of the viewfinder.
- 5 When you are done recording, tap .

Change Video Settings

You can change the camera settings for best results when recording video.

- 1 Press the **Camera** button or tap All Apps and then tap Camera .
- 2 Tap .
- 3 Tap  to view the options for video.
- 4 Tap the grid or the flash icon to turn the option on or off.

6

Configure the Computer

Use this chapter to learn how to configure the computer. You will also find information on how to configure network communications and wireless security.

How to Configure the Computer

You can configure many parameters on the computer such as the bar code symbologies it decodes, or the network settings. The values you set for these parameters determine how the computer operates.

You configure the computer using the Settings app.

Start the Settings App

The Settings app is located in the All Apps menu.

- Tap **All Apps > Settings**.



About the Structure of the Settings App

Use this section to learn about the structure of the Settings app so you can find parameters quickly.

Wireless & Networks

Setting	Description
Wi-Fi	Turns the Wi-Fi radio on and off. When Wi-Fi is turned on, tap the bar to see a list of Wi-Fi networks.
Bluetooth	Turns the Bluetooth radio on and off. when bluetooth is turned on, tap the bar to see a list of Bluetooth devices in range.
Data usage	Displays a list of phone data usage for the current data usage cycle. Tap the Data usage cycle list to select another date range.
More...	<p>Airplane mode: Turns airplane mode on and off.</p> <p>Default SMS app:</p> <p>NFC: Turns on NFC which allows data exchange when the computer touches another device.</p> <p>Android Beam: When NFC is enabled, this feature lets you beam app content to another NFC-capable device by holding the devices close together. The app determines what content gets beamed.</p> <p>VPN: Sets the password parameters for a virtual private network (VPN).</p> <p>Mobile networks: Includes settings for mobile networks, including enabling data access and roaming over mobile networks, selecting access points and network operators, or selecting only 2G networks (to save battery life).</p> <p>Mobile plan: Provides information on your cell phone plan.</p> <p>Cell broadcasts: Sets what emergency information you want to receive and how you want to receive it.</p>

Device

Setting	Description
Sound	Settings for the phone and notification sounds, including tones and volume.
Display	Settings for the display brightness, wallpaper, sleep timeout, font size, and screen auto-rotation.
Storage	Shows the remaining amount of storage.

Device (continued)

Setting	Description
Battery	Shows battery usage data and the current battery state.
Apps	Lists downloaded and running apps.

Personal

Setting	Description
Location	Turns location services (Google and GPS satellite data) on and off.
Security	Sets screen lock and administrator privileges.
Language & input	Selects the active language and default keyboard. Sets auto-typing features such as capitalization and punctuation. Adjusts the pointer speed for an external mouse or trackpad.
Backup & reset	Restores factory default settings.

Honeywell Settings

Setting	Description
Key remap	Remaps the Left Scan, Right Scan, and Camera buttons. For help, see “Remap a Button” on page 30 .
Smart sensors	Configures the integrated motion detection sensors for advanced power management.
Battery LED	Configures the battery LED behavior.
Battery Health	View the current health of the battery.
Logger	Activates a logging service that creates an Android logcat log and kernel log for APP and system troubleshooting.
Scanning	Configures the computer imager. For help, see “Change the Scanner Settings” on page 38 .
Web applications	Enables the web interface settings and lets you set a port.

Accounts

Setting	Description
Add account	Adds a Corporate or Email account to the computer.

System

Setting	Description
Date & time	Configures all date and time settings
Accessibility	Sets accessibility levels, such as larger display text and enabling text-to-speech output.
Printing	Configure the printing options.
Developer options	Enables developer-specific options such as USB debugging and SD card protection.
About phone	Provides information about your computer such as battery status, model number, and Android version.

About Network Communications

You can use the mobile computer in your wireless or wired data collection network. You can connect your computer using:



- 802.11 radio communications.
- Ethernet communications.
- Bluetooth communications.
- USB and serial communications.

Connect to a Wi-Fi Network

The computer has an 802.11 radio to transfer data using wireless communications. Before you connect to a Wi-Fi network, you need to know about your network security protocol and its required credentials. By default, the 802.11 radio is disabled.

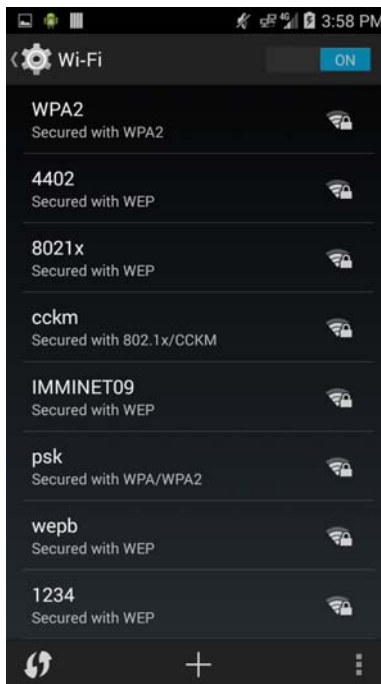
- 1 Start the Settings app and slide the Wi-Fi switch on.
- 2 When the switch turns blue, tap **Wi-Fi**. A list of discovered networks appears.



- 3 To quickly connect to a network through Wi-Fi Protected Access (WPS), tap . To search for a network not in the list, tap  and type the network name.
- 4 Tap a network name in the list to view details:

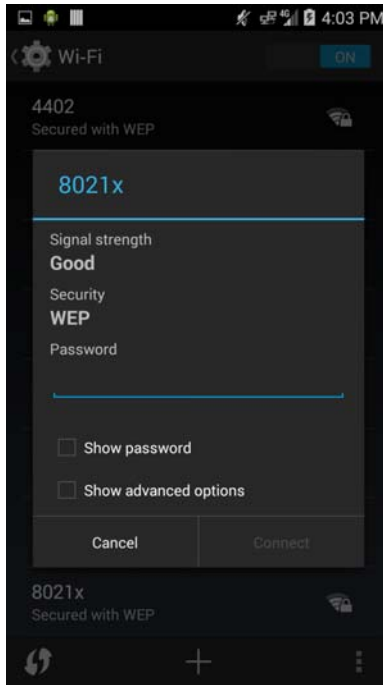

If the network is secured, a list of required information appears (such as a certificate name, a password, or other credentials). To connect to the secured network, enter the required information and tap **Connect**.

- To leave a connected network, tap **Forget**. For example, you could choose to forget a network you no longer use.
- To close the network details screen, tap **Cancel**.

Configure Proxy Settings for a Wi-Fi Network

If you need to connect to network resources through a proxy server, you can configure settings for the proxy server for each Wi-Fi network you add. By default, the Wi-Fi networks you add are not configured to connect through a proxy server.



Note: Proxy settings apply only to the Wi-Fi network you modify. You must change proxy settings for each network requiring a proxy server.

- 1 Open the Settings app and tap **Wi-Fi**. The list of available Wi-Fi networks appears.
- 2 Tap and hold the network name and then tap **Modify network**. A list of network settings appears.
- 3 At the bottom of the list of network settings, select **Show advanced options**.
- 4 If the network has no proxy settings, tap **None** in the Proxy Settings list, and then tap **Manual** in that list.
- 5 Enter the proxy settings for the network.
- 6 Tap **Save**.

Disable Wi-Fi Notifications

By default, when Wi-Fi is enabled, you receive notifications in the Status bar when the computer discovers a wireless network. You can disable these notifications.

- 1 Start the Settings app.
- 2 Tap and hold **Wi-Fi**.
- 3 Tap and then tap **Advanced**. The Advanced Wi-Fi menu appears.
- 4 Clear the **Network notification** check box to disable notifications.

Connect to an Ethernet Network

To connect the computer to an Ethernet network, you need an Ethernet dock.

- 1 Make sure the dock is connected to your Ethernet network.
- 2 Place the computer in the dock.
- 3 Start the Settings app and make sure Ethernet is enabled (Ethernet is enabled by default).

To enable Ethernet, slide the Ethernet switch on. When the switch turns blue, Ethernet is enabled.

- 4 Tap **Ethernet**. The Ethernet list shows the name of the current Ethernet connection. By default, the computer assumes a DHCP connection, and that your network has assigned an IP address

automatically. If DHCP is working, the Ethernet dock should indicate that communication with the network is occurring.

- 5 (Optional) To assign a static IP address, tap the connection name (for example, eth0). The IP settings dialog box appears.
 - a Tap **DHCP** and then select **Static** from the list.
 - b Enter the required network information and then tap **Apply**.

How to Connect to Virtual Private Networks

The computer supports connecting to virtual private networks (VPNs). This section describes how to add and connect to VPNs. To configure VPN access, you must obtain details from your network administrator. You view and change VPN settings in the Settings app.



Note: Before you can access VPNs, you need to set a lock screen PIN or password.

Add a VPN

Before you can connect to a VPN, you must add VPN information.

- 1 Start the Settings app.
- 2 In the Wireless & Networks section, tap **More**.
- 3 Tap **VPN**.
- 4 Tap **Add VPN Profile**.
- 5 Enter information for the VPN.
- 6 Tap **Save**. The VPN name appears in the VPN list.

Connect to a VPN

- 1 Start the Settings app.
- 2 In the Wireless & Networks section, tap **More**.
- 3 Tap **VPN**.
- 4 Tap the name of the VPN in the list, and enter any necessary credentials when prompted.
- 5 Tap **Connect**. The computer connects to the VPN, and a Status icon and notification appear.

To disconnect from the VPN, tap the notification.

Edit VPN Information

- 1 Start the Settings app.
- 2 In the Wireless & Networks section, tap **More**.
- 3 Tap **VPN**.
- 4 Tap and hold the name of the VPN you want to edit, and select **Edit network** from the list.
- 5 Edit VPN settings as necessary.
- 6 When you are done, tap **Save**.

About Wireless Security

The computer provides these security solutions for your wireless network:

- Wi-Fi Protected Access 2 (WPA2™)
- Wi-Fi Protected Access (WPA)
- 802.1x
- LEAP
- WEP

Honeywell recommends WPA2 security with PSK (Personal) or 802.1x (Enterprise) key management.

Before you set security, you need to enable the radio, set the date, and set the SSID on your computer. To use 802.1x security, you need to load a root certificate on your computer. To use transport layer security (TLS) with 802.1x security, you also need to load a user certificate.

Use the Settings app to access and configure all wireless security settings.

About Certificates

You can use digital certificates to identify the computer for network access or authentication to servers. To use a certificate to identify your device, you must install it in the trusted credential storage on the computer.

Android supports DER-encoded X.509 certificates saved in files with a .crt or .cer file extension. To install a valid certificate with a .der or it. Android also supports X.509 certificates saved in PKCS#12 key store files with a .p12 or .pfx extension. To install a valid key store file with another extension, you must change the extension to .p12 or .pfx to install it. When you install a certificate from a PKCS#12 key store, Android also installs any accompanying private key or certificate authority certificates.

Load a Certificate

To use a certificate, you must install it in the trusted credential storage on the computer.



Note: Apps such as Email and Browser that support certificates allow you to install certificates directly from within the app. For more information, see the Help that comes with the app.

- 1 Copy the certificate or key store from your PC to a microSD card.
- 2 Install the microSD card in the computer and turn the computer on.
- 3 Start the Settings app and tap **Security > Install from SD card**.
- 4 Tap the name of the certificate or key store to install it. If prompted, enter the key store password and tap **OK**.
- 5 Enter a name for the certificate and tap **OK**.

Disable or Remove Certificates

If a certificate is compromised, or your organization chooses not to trust it, you can disable or remove it.

- 1 Start the Settings app and tap **Security > Trusted credentials**. The trusted credentials screen has two tabs:
 - **System** shows CA certificates that are installed in the ROM.
 - **User** shows CA certificates you have installed yourself.
- 2 Tap the name of the certificate to disable or remove. The certificate details screen appears.
- 3 Scroll to the bottom of the details screen and tap **Disable** (for System certificates) or **Remove** (for User certificates).

If necessary, you can enable a disabled System certificate from this location. If you remove a User certificate, you must install it again to enable it.
- 4 Tap **OK**.

About Bluetooth Communications

The computer is Bluetooth-enabled, which lets you connect to other Bluetooth devices.

You need to turn on the Bluetooth radio before you can discover and connect to Bluetooth devices. By default, the radio is turned off.

The Bluetooth radio maintains its current state through a system reset. If you perform a factory data reset, you must recreate pairings to devices.

The System bar icons indicate Bluetooth status.

Connect a Bluetooth Device

To connect to a Bluetooth device, you must enable Bluetooth and then select the device from a list of discovered devices.

- 1 Start the Settings app.
- 2 If Bluetooth is off, slide the Bluetooth switch on.
- 3 Tap **Bluetooth**. A list of available Bluetooth devices appears.

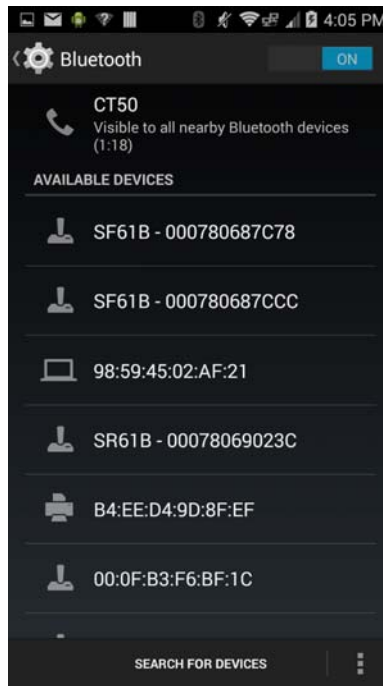

- 4 (Optional) If the device you want does not appear in the list, make sure the device is turned on and discoverable, and tap **Search for devices**.
- 5 Tap a device in the list to select it. If a pairing request message appears, enter the device PIN and tap **OK**. When the device is paired with the computer, the device name appears in **Paired Devices** at the top of the list.

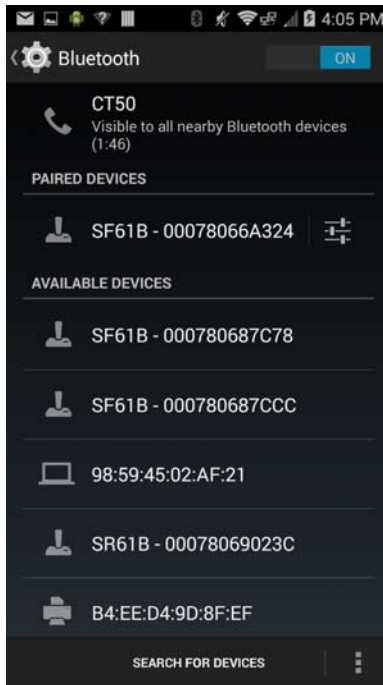

- 6 To disconnect a paired device, tap the Quick Settings icon  next to the device name and then tap **Unpair**.

Configure Bluetooth Settings

You configure Bluetooth settings in the Settings app.

- 1 Start the Settings app and tap **Bluetooth**.
- 2 Tap the Menu icon  and select a setting from the menu:
 - Tap **Rename phone** to change the computer device name. Type the new name and then tap **Rename**.
 - Tap **Visibility timeout** to set the amount of time that the computer is visible to other Bluetooth devices. By default, the timeout is set to 2 minutes. You can select 5 minutes, one hour, or no timeout. Setting a shorter timeout value preserves battery life.
 - Tap **Show received files** to view statistics on the received files.

Making the Computer Discoverable

By default, the computer is not discoverable, which means that the computer will not be found by other Bluetooth devices.

- 1 Tap **All Apps > Settings**.
- 2 Verify the **Bluetooth** radio is turned on.
- 3 Tap **Bluetooth**.
- 4 Tap **CT50** (the default computer name) at the top of the screen to make the device discoverable. The computer starts a 2 minute count down during which time the computer is temporarily discoverable by other devices using Bluetooth technology.

Rename or Disconnect a Paired Device

You can rename or disconnect a paired Bluetooth device from the Settings app.

- 1 Open the Settings app and tap **Bluetooth**.
- 2 Tap the Settings icon  in the **Paired Devices** list.
- 3 To rename the device, tap **Rename**, type the new name, and then tap **OK**.
 - To disconnect the device, tap **Unpair**.

About Serial and USB Communications

You can use these accessories to transmit data to and receive data from another device through serial or USB communications:

- vehicle dock
- HomeBase
- Ethernet HomeBase
- USB snap-on adapter
- DEX adapter

For information on these accessories, contact your local sales representative.

If you have a problem with your PC recognizing the USB device, you can download and install the Honeywell-aidc-usb-driver. The driver is part of the Honeywell_MobilitySDK_Android software .zip file. The SDK is available from www.honeywellaidc.com > **Products** > **Mobile Computers** > **Handheld Mobile Computer** > **Dolphin CT50** > **Software** tab.

About Near Field Communication (NFC)

NFC technology provides the ability for short-range, wireless data transfer between the computer and NFC tags or other NFC enabled devices placed in close proximity to the back of the computer. NFC equipped computer models support the following modes of operation:

- **NFC tag reader/writer mode:** The computer reads and/or writes digital information from or to an NFC tag.
- **Peer-to-Peer (P2P) mode:** The computer uses Android Beam and/or Bluetooth technology to transfer screen content (such as a picture, contact information, Web page url, or file) between NFC enabled devices.

- **NFC card emulation mode:** The computer emulates an NFC card (smart card) that an external card reader can access. You have the option to enable the embedded secure element (eSE) SmartMX™ or Host Emulation. Secure element implementation is commonly used for financial transactions or coupon and loyalty mobile marketing applications that require a secure memory and execution environment for the storage of personal information (such as account information and credentials) and running custom smart card applets.



Note: Sleep Mode (Suspend Mode) and the screen lock temporarily turns the NFC radio off.

7

Manage and Maintain the Computer

Use this chapter to understand how to upgrade software, reset the computer, and maintain the computer.

How to Upgrade the System Software

Upgrades for Power Tools and other system software on the computer are provided as .zip files and are available from Technical Support (www.hsmcontactsupport.com) or www.honeywellaidc.com.

- 1 Copy the upgrade .zip file into one of these folders on the computer:
 - Internal storage\honeywell\autoinstall
 - IPSM card\honeywell\autoinstall
 - \honeywell\autoinstall (on a microSD card if installed)
- 2 Tap **All Apps > Power Tools > AutoInstall Settings**.
- 3 Verify that Autoinstall is enabled.
- 4 Select **Packages Update** from the screen. The computer automatically initiates a reboot and installs the software upgrade.

How to Restart the Computer

If the computer or an application locks up, or if the computer does not respond when you press the **Power** button, you may need to restart the computer.

The computer uses the configuration currently saved in flash memory during the boot process. Try these methods, in order, to restart the computer:

- **Reset:** Restarts the computer and goes through the initialization process.
- **Clean boot:** Completely erases the computer memory, including all applications and data files, except those in the Flash File Store or any removable storage.

Reset the Computer

You may need to restart the computer to correct conditions where an application stops responding to the system.

- 1 Save your files and close any open applications.
- 2 Press and hold the **Power** button. This screen appears:

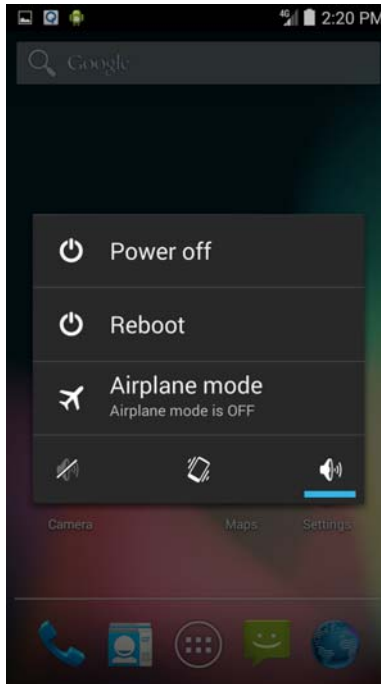

- 3 Tap **Power off**.
- 4 When prompted that the computer will shut down, tap **OK**.
- 5 Press the **Power** button to turn on the computer.

Clean Boot the Computer

If the computer seems to be locked up, try cold booting it. If reset does not work, use a clean boot to get the computer up and running for further troubleshooting.



Caution: A clean boot erases the memory on the computer, including all applications and data files with the exception of the information in the Flash File Store or any removable storage.

- 1 Tap **All Apps** > **Settings**.
- 2 Tap **Backup & Reset**.
- 3 Tap **Factory Data Reset**.
- 4 Select any options you want to include, such as erasing the SD card.
- 5 Tap **Reset phone**. The computer performs the clean boot procedure and turns off.
- 6 Press the **Power** button to turn on the computer. You will need to set up your computer again.

Clean the Computer



Note: You can use this basic cleaning process to clean the CT50 and CT50h computers. However, please refer to the Honeywell *Disinfectant-Ready Housings Data Sheet* on www.honeywellaidc.com for a list of tested disinfectants and recommendations for disinfecting the CT50h computer.

To keep the computer in good working order, you may need to clean the scanner window, color camera window, and the touch screen. Clean the windows and the touch screen as often as needed for the environment in which you are using the computer. The computer will withstand application of the following cleaning agents when applied to a clean soft cloth and removed immediately with a dry soft cloth:

- Acetic acid, 10% in water
- Ethyl alcohol, 10% in water
- Mild soap solutions



Caution: There are no user-serviceable parts inside the computer. Opening the computer will void the warranty and may cause damage to the internal components.



Note: Honeywell recommends that you leave the battery installed when you clean the computer. Leaving the battery installed helps prevent fluids from entering the computer through the microSIM card and microSD card connectors.

- 1 Press the **Power** button to suspend the computer.
- 2 Dip a clean cloth towel in the cleaning agent and wring out the excess.

- 3** Wipe off the scanner window, camera lens, and flash area. Do not allow any abrasive material to touch these surfaces.
- 4** Wipe dry.
- 5** Let the computer completely air dry before using again.

A

Specifications

Physical and Environmental Specifications

This sections lists the physical and environmental specifications for the CT50.

CT50 Physical Dimensions

Length:	160 mm
Width:	82.5 mm
Depth:	19 mm
Weight (with battery):	342 g (including battery)

CT50 Tumble and Drop Specifications

Tumble specification:	1000 1 m tumbles
Drop specification:	5 ft multiple drops to unyielding steel plate, -10 to +50 °C temperature range and 4 ft drop at 20 ° C

CT50 Power and Electrical Specifications

Battery Pack:	Rechargeable Lithium-ion 3.6 V, 4040 mAh battery
Electrical rating:	5 V, 2 A

CT50 Temperature and Humidity Specifications

Operating temperature:	-20 °C to 50 °C (-4 °F to 122 °F)
Storage temperature:	-30 °C to 70 °C (-22 °F to 158 °F) For maximum battery life, store at 23 °C (73 °F) at 50% charge.
Relative humidity (operating):	0% to 95% non-condensing
Environmental rating:	IP67, Category 1

This sections lists the physical and environmental specifications for the CT50h.

CT50h Physical Dimensions

Length:	160 mm
Width:	82.5 mm
Depth:	19 mm
Weight (with battery):	342 g (including battery)

CT50h Tumble and Drop Specifications

Tumble specification:	500 1 m tumbles at room temperature
Drop specification:	4 ft multiple drops to an unyielding surface at room temperature

CT50h Power and Electrical Specifications

Battery Pack:	Rechargeable Lithium-ion 3.6 V, 4040 mAh battery
Electrical rating:	5 V, 2 A

CT50h Temperature and Humidity Specifications

Operating temperature:	0 °C to 35 °C (32 °F to 95°F)
Storage temperature:	-20 °C to 45 °C (-4 °F to 113 °F) For maximum battery life, store at 23 °C (73 °F) at 50% charge.
Relative humidity (operating):	0% to 95% non-condensing
Environmental rating:	IP54
Chemical resistance:	Protects against Sani-Cloth®, Super Sani-Cloth® Wipes, and Virex 256

Screen Specifications

4.66-inch TFT color LCD with backlight, 720p HD, outdoor viewable touch screen.

Language Support

World-wide English, French, German, Italian, Spanish, Simplified Chinese, Traditional Chinese.

Bar Code Symbolologies Supported

The computer supports these bar code symbolologies:

1D Symbolologies

- Codabar
- Code 3 of 9
- Code 11
- Code 32
- Code 93
- Code 128
- EAN-8
- EAN-13
- GS1-128
- Korea Post
- IATA 2 of 5
- Industrial 2 of 5
- Interleaved 2 of 5
- ISBN
- ISBT 128
- Matrix 2 of 5
- MSI Plessey
- EAN.RCC (RSS-14)
- RSS Limited
- RSS Expanded
- Telepen
- Trioptic Code
- UPC-A
- UPC-E

2D Symbologies

- Aztec Code
- Codablock A
- Codablock F
- DataMatrix
- HanXin
- Maxicode
- Micro PDF 417
- MicroQr
- PDF 417
- QR Code
- TLC39
- OCR-A
- OCR-B

Postal Codes

- Australian Post
- Canadian Post
- KIX (Netherlands Dutch) Post
- Japanese Post
- British Post
- Planet Code
- Postnet
- UsIntelligent

Imager Reading Distances

The guaranteed depth of field measurements were taken using these parameters:

- Distances are measured from the front of the engine.
- 23 °C (73 °F), 0 lux
- Photographic quality codes



Note: Time to Read and Depth of Field are impacted if the bar code symbol is at the edge of the image.

White Illumination Monochrome Sensor Only - Guaranteed Specs

Focus Symbology	Standard Range (SR)		
	Near Distance (in/cm)	Far Distance (in/cm)	Delta (in/cm)
5 mil Code 39/128	3.6 (9.1)	5.6 (14.2)	2.0 (5.1)
10 mil Code 39/128	1.9 (4.8)	12.0 (30.5)	10.1 (25.6)
100% UPC	2.1 (5.3)	15.1 (38.1)	12.9 (32.7)
6.7 mil PDF 417	2.5 (6.4)	6.6 (16.7)	4.1 (10.4)
10 mil DataMatrix/Aztec	2.9 (7.4)	7.3 (18.5)	4.4 (11.1)

White Illumination Monochrome Sensor Only - Typical Specs

Focus Symbology	Standard Range (SR)		
	Near Distance (in/cm)	Far Distance (in/cm)	Delta (in/cm)
5 mil Code 39/128	2.5 (6.4)	6.4 (16.3)	3.9 (9.9)
10 mil Code 39/128	1.1 (2.8)	13.0 (33.0)	11.9 (30.2)
100% UPC	1.8 (4.6)	16.5 (41.9)	14.7 (37.3)
6.7 mil PDF 417	1.8 (4.6)	7.3 (18.5)	5.5 (14.0)
10 mil DataMatrix/Aztec	2.1 (5.3)	8.0 (20.3)	5.9 (15.0)

Honeywell

www.honeywellaidc.com

Copyright © 2016
Honeywell International Inc.
All rights reserved.

Dolphin CT50 and CT50h Mobile Computer for Android User Guide



P/N CT50AND-ENUS-UG Rev B