



THE POWER OF **CONNECTED**

Dolphin™ CT60

powered by Android™ 7

Quick Start Guide

Out of the Box

Make sure that your shipping box contains these items:

- Dolphin CT60 mobile computer (Model CT60LON or CT60L1N)
- Rechargeable 3.6 VDC Li-ion battery
- Product documentation

If you ordered accessories for your mobile computer, verify that they are also included with the order. Be sure to keep the original packaging in case you need to return the mobile computer for service.

Note: *CT60LON models do not include a WWAN radio.*

Memory Card Specifications

Honeywell recommends the use of Single Level Cell (SLC) industrial grade microSD™ or microSDHC™ memory cards with Dolphin mobile computers for maximum performance and durability. Contact a Honeywell sales representative for additional information on qualified memory card options.

Mobile Computer Features

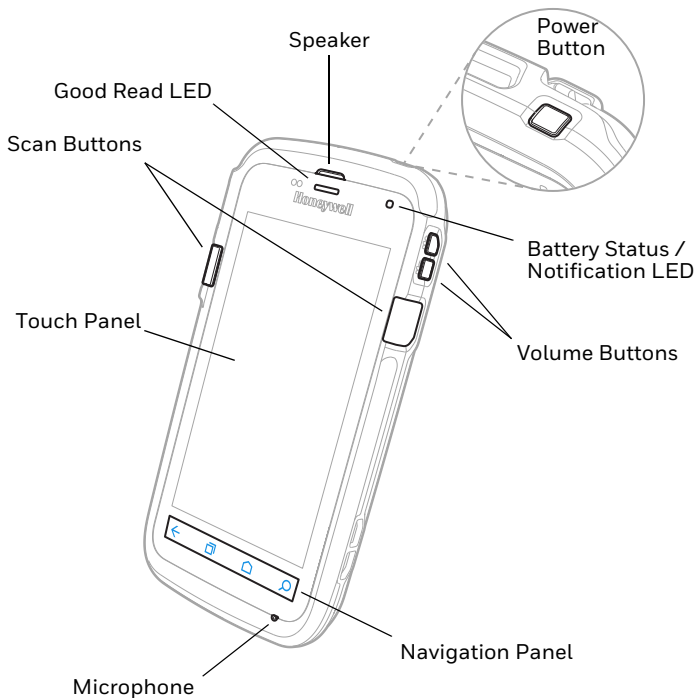

Note: Hand strap not shown.

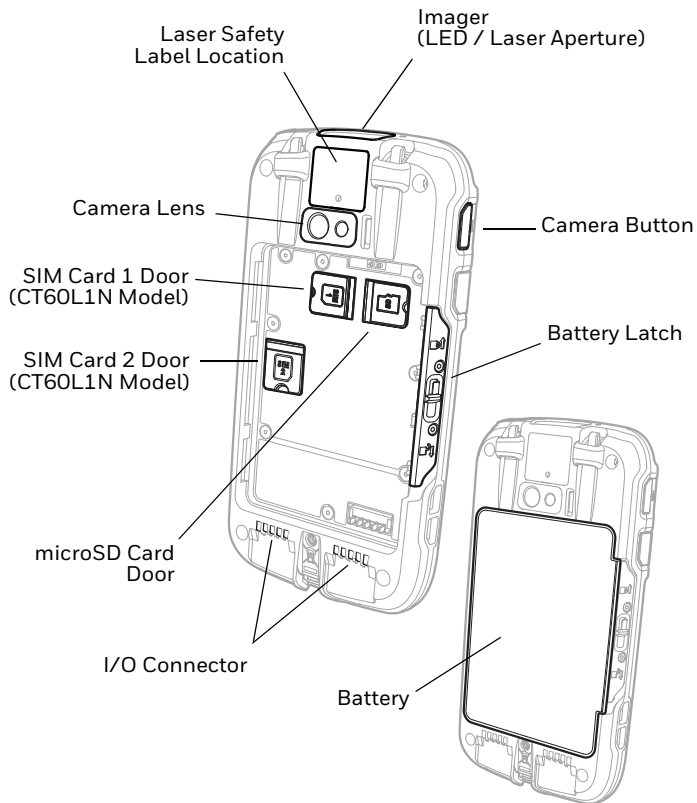

Install a microSD Card (SD)

Note: Format the microSD card before initial use.

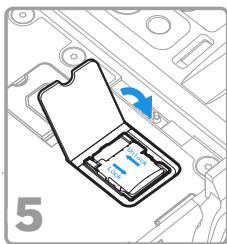
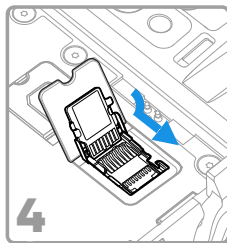
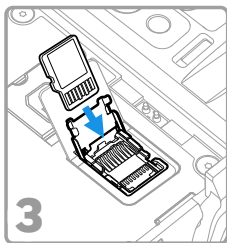
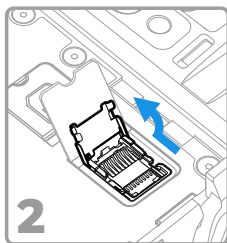
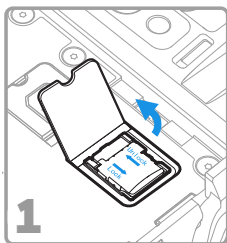

Note: Always power off the computer and remove the battery before attempting to install or remove a card.

Install a microSIM Card (SIM 1)

Note: Feature available on CT60L1N Models only.

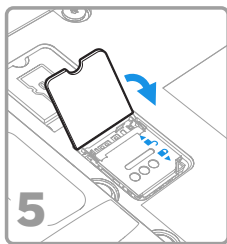
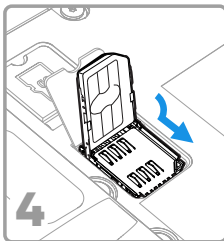
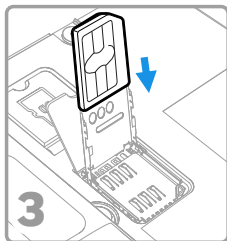
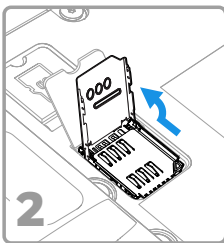
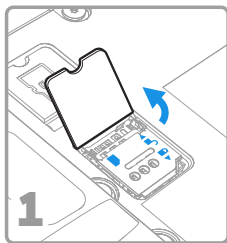

Note: Always power off the computer and remove the battery before attempting to install or remove a card.

Install a Secondary microSIM Card (SIM 2)

Note: Feature available on CT60L1N Models only.

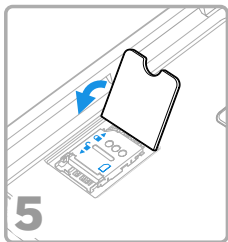
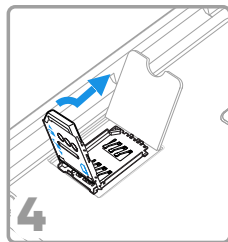
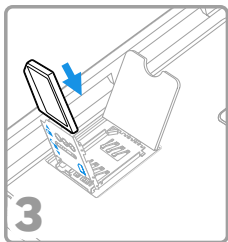
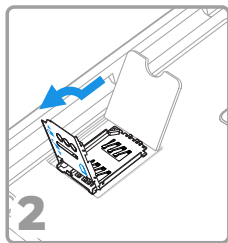

Note: Always power off the computer and remove the battery before attempting to install or remove a card.

Install the Battery

The CT60 mobile computer ships with a Li-ion 3.6 VDC, 14.6 watt-hour battery manufactured for Honeywell International Inc.



We recommend use of Honeywell Li-ion battery packs. Use of any non-Honeywell battery may result in damage not covered by the warranty.

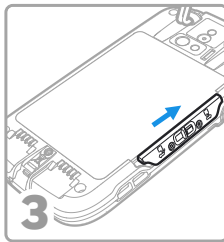
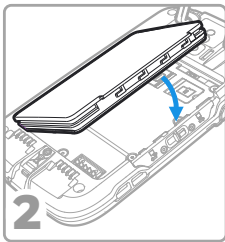
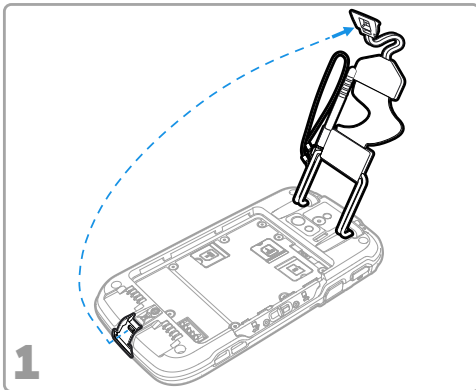

Ensure all components are dry prior to placing the battery in the computer. Mating wet components may cause damage not covered by the warranty.

Charge the Mobile Computer

The CT60 mobile computer ships with a partially charged battery. Charge the battery with a CT50 Series charging device for a minimum of **4 hours**. Using the computer while charging the battery increases the time required to reach a full charge.



We recommend the use of Honeywell accessories and power adapters. Use of any non-Honeywell accessories or power adapters may cause damage not covered by the warranty.

CT60 mobile computers are designed for use with the following CT50 Series charging accessories: HomeBase, Ethernet HomeBase, ChargeBase, NetBase, Quad Battery Charger, Vehicle Power Adapter, Vehicle Dock, and USB Adapter.



Ensure all components are dry prior to mating the computers and batteries with peripheral devices. Mating wet components may cause damage not covered by the warranty.

Turn Power On/Off

To turn the computer on:

- Press and release the **Power** button.

To turn the computer off:

1. Press and hold the **Power** button until the options menu appears.
2. Touch **Power Off**.
3. When prompted to shut down the computer, touch **OK**.

Note: *You should always power off the computer before removing the battery.*



Sleep Mode

Sleep mode automatically turns the touch panel display off and locks the computer to save battery power when the computer is inactive for a programmed period of time.

1. Press and release the Power button to wake the computer.
2. Drag the  toward the top of the display to unlock the computer.

Adjust the Display Sleep Time

To adjust the amount of time before the display sleeps after inactivity:





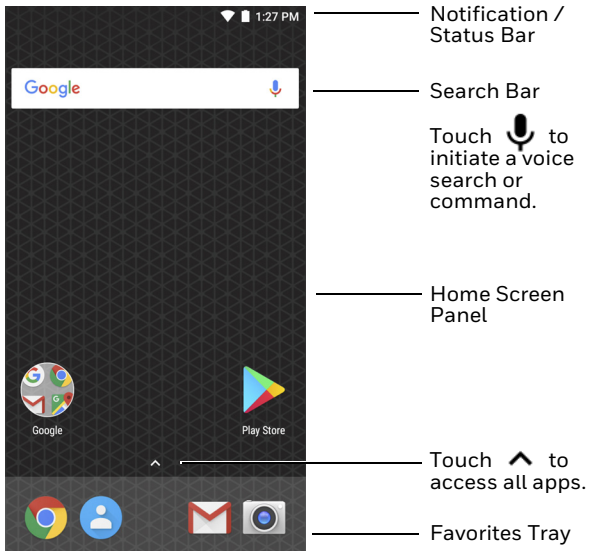

1. Touch  > **Settings** > **Display** > **Sleep**.
2. Select the amount of time before the display goes to sleep.
3. Touch  to return to the Home screen.

About the Home Screen

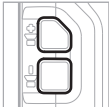
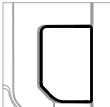

To learn how to customize the Home screen, see the user guide.

Navigation and Function Buttons

Button	Description	
	Back	Return to the previous screen.
	Recent Apps	View and switch between recently used apps.
	Home	Return to the Home screen.
	Search	Start a search on the computer or the Internet.
	Volume	Raise or lower the volume of the speaker.
	Scan	Press right or left scan button to trigger the scanner.
	Camera	Press to open the camera app and take a photo.

To learn more about how to re-map a button, see the user guide.

Scan a Bar Code with the Scan Demo

Note: For optimum performance, avoid reflections by scanning the bar code at a slight angle.

1. Touch **^** > **Demos** > **Scan Demo**.
2. Point the computer at the bar code.
3. Touch **Scan** on the touch screen or press and hold a **Scan** button. Center the aiming beam over the bar code.

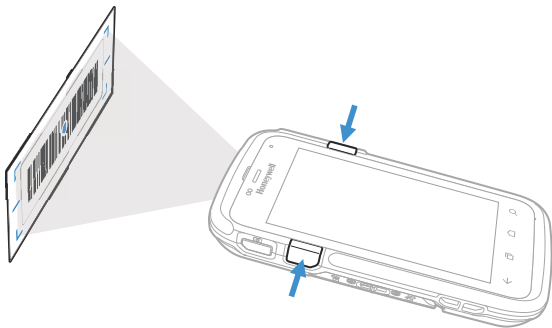

The decode results appear on the screen.

Note: In the Scan Demo app, not all bar code symbologies are enabled by default. If a bar code does not scan, the correct symbology may not be enabled. To learn how to modify the default app settings, see the user guide.

Sync Data

To move files between your CT60 and a computer:

1. Connect the CT60 to your computer using a USB charge/communication accessory.
2. By default, the CT60 is in USB charging only mode. To enable file transfers, swipe down from the top of the Home screen to access the Notifications panel.
3. Touch the USB notification, and then select either **Transfer files** or **Transfer photos (PTP)**.
4. Depending on the Windows® operating system on your computer, either open **File Explorer** or **Windows Explorer**.
5. Under “Computer” or “This PC”, click on the CT60. You can now copy, delete and/or move files or folders between the computer and CT60 or a microSD card installed in the CT60 as you would with any other storage drive (e.g., cut and paste or drag and drop).

Restart the Mobile Computer

You may need to restart the mobile computer to correct conditions where an application stops responding to the system or the computer seems to be locked up.

1. Press and hold the **Power** button until the options menu appears.
2. Select **Reboot** and then **OK**.

To restart the computer if the touch panel display is unresponsive:

- Press and hold the Power button for approximately 8 seconds until the computer restarts.

Note: *If you try to restart the computer and still experience issues, you may need to see the user guide for information on how to perform a Factory Reset (Clean Boot).*

Support

To search our knowledge base for a solution or log into the Technical Support Portal and report a problem, go to www.hsmcontactsupport.com.

User Documentation

For the user guide and other documentation, go to www.honeywellaidc.com.

Limited Warranty

For warranty information, go to www.honeywellaidc.com and click **Get Resources** > **Product Warranty**.

Patents

For patent information, see www.hsmpats.com.

Trademarks

Android is a trademark of Google LLC.

Windows is either a registered trademark or registered trademark of Microsoft Corporation in the United States and/or other countries.

Disclaimer

Honeywell International Inc. (“HII”) reserves the right to make changes in specifications and other information contained in this document without prior notice, and the reader should in all cases consult HII to determine whether any such changes have been made. The information in this publication does not represent a commitment on the part of HII.

HII shall not be liable for technical or editorial errors or omissions contained herein; nor for incidental or consequential damages resulting from the furnishing, performance, or use of this material. HII disclaims all responsibility for the selection and use of software and/or hardware to achieve intended results.

This document contains proprietary information that is protected by copyright. All rights are reserved. No part of this document may be photocopied, reproduced, or translated into another language without the prior written consent of HII.

Copyright © 2017–2018 Honeywell International Inc. All rights reserved.